

lifeAGLOW®

LANDSCAPE 2021

# HINKLEY

# HINKLEY

THIS CATALOG INCLUDES HINKLEY'S FULL LINE OF  
LANDSCAPE LIGHTING. FOR FANS, INTERIOR, BATH  
AND OUTDOOR LIGHTING, SEE [HINKLEY.COM](http://HINKLEY.COM)

HINKLEY, INC. | 2021



# WE'VE GOT YOU COVERED

WE OFFER A WIDE RANGE OF PRODUCTS, FROM PATH, BOLLARDS, ACCENT, HARDSCAPE, INDICATOR AND SPOT LIGHTS, TO COORDINATING LANTERNS, POST AND PIER MOUNTS. FOR PREMIUM OUTDOOR LIVING AREAS, LOW VOLTAGE CHANDELIERS AND PENDANTS ENHANCE EXTERIOR SPACES WITH EASE. LET'S GET GLOWING!







## #HINKLEYSTYLE

Social media is the ultimate creative platform—a community of individuals, influencers and brands connected by a show and tell ideology. And most of all, it's fun! We invite you to join our social circle, where we share our passion for stylishly curated living.



## SHARE THE LOVE

Share your chic outdoor space with us and your Instagram followers with **#hinkleystyle**. We love to repost images of our landscape lighting all year round. Follow **@hinkleylighting** for the latest in lighting, style, décor and more!



# TABLE OF CONTENTS

Hinkley Landscape Lighting allows you to creatively illuminate all types of exterior environments and increase enjoyment of your favorite natural spaces throughout the evening hours. Explore all we have to offer: from inspiration to installation, we've got you covered.

Welcome	01
#hinkleystyle	02
SPARTA	04
Lighting Techniques	06
Outdoor Living Lighting 101	08
Coordinate + Complement	09
Coordinating Fixtures	10
Design Spotlight	12

## 12 VOLT LANDSCAPE LIGHTING

<b>ACCENT LIGHTING</b>	13
Calder Pendant Lights	30
LumaCORE	14
Spot + Flood Lights	22
Well Lights	26

<b>PATH + AREA LIGHTING</b>	31
Bollards	32
Path Lights	37

<b>DECK, STEP AND PATIO LIGHTING</b>	55
Brick Lights	63
Deck Lights	61
Luna Step Lights	68
Nuvi Collection	56
Taper Deck Lights	64
Taper Step Lights	66

<b>LOW VOLTAGE LUXURY LIGHTING</b>	72
Chandeliers	80
Pier Mounts	77
Post Mounts	73

<b>120 VOLT LANDSCAPE LIGHTING</b>	86
Bollards	90
Luna Step Lights	92
Path Lights	87
Spot Lights	88
Step + Brick Lights	99
Terrace Sign Lights	98
Well Lights	100

<b>TRANSFORMERS</b>	104
---------------------	-----

<b>ACCESSORIES</b>	
12 Volt	103
120 Volt	102

<b>LAMPS</b>	
LED PAR36	112
LED	114
LumaCORE Photometrics	110

<b>DESIGN + INSTALLATION GUIDES</b>	
Incandescent	120
LED	118
Index	123

## ICON GUIDE

THROUGHOUT THIS CATALOG WE HAVE UTILIZED A VARIETY OF IMPORTANT ICONS TO ASSIST WITH YOUR LIGHTING SELECTIONS. THIS KEY DESCRIBES EACH ICON IN DETAIL FOR EASY REFERENCE.

-  **12V**  
Item is low voltage luxury lighting.
-  **120 VOLT**  
Indicates a line voltage fixture that is able to accommodate lamps with a higher wattage and light output. Ideal for commercial and public spaces.
-  **ADA COMPLIANT**  
Indicates fixtures that adhere to the standards and guidelines listed by the Americans with Disabilities Act.
-  **COASTAL ELEMENTS**  
Versatile designs offering maximum durability in harsh climates.
-  **COASTAL SERIES**  
Coastal Series fixtures are constructed from sturdy copper and brass. Designed for harsh environments.
-  **DIMMABLE**  
Item is dimmable.
-  **HARDY ISLAND**  
Fixture is constructed from heavy duty solid cast brass and features a weathered brass finish. Designed for harsh environments.
-  **INTEGRATED LED**  
Each energy-efficient fixture is equipped with a fully integrated LED panel and built-in driver.
-  **OPEN AIR**  
Chic designs rated for use in both interior and exterior spaces.





# SPARTA

STAINLESS STEEL

## EXPAND YOUR HORIZONS

Explore Sparta's sleek, contemporary collection and imagine the possibilities.

The ultra-modern Sparta series is constructed with heavy duty cast 316 stainless steel for virtually indestructible lighting. Four robust designs - Dot, Tilt, Flare and Dash - are expertly engineered to ensure flexibility for a variety of applications.

For more details on the newest addition to Hinkley's luxury landscape lighting portfolio, visit [Hinkley.com/Sparta](https://www.hinkley.com/Sparta).

---

## SPARTA SNAPSHOT

**Construction:** 316 Stainless Steel

**Power:** 12V

**Color Temperature:** 3000K

Suitable for Indoor/Outdoor use - WET rated

Available concrete pour kit

Transformer required, see page 104



## DOT

Dot indicator lighting is a recessed integrated LED inground landscape luminaire featuring durable clear optic glass and constructed with cast 316 stainless steel. Available in both small and large sizes, as well as round and square contemporary forms for up, down and side light applications to ensure maximum flexibility. Mounting sleeve included.



**15074 SS**  
DOT LED SMALL  
ROUND BUTTON LIGHT

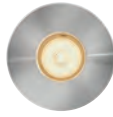

**15075 SS**  
DOT LED LARGE  
ROUND BUTTON LIGHT



**15084 SS**  
DOT LED SMALL  
SQUARE BUTTON LIGHT



**15085 SS**  
DOT LED LARGE  
SQUARE BUTTON LIGHT

## FLARE

Flare's integrated LED indicator lighting is available in either small or large uni-directional well lights, as well as small or large quad-directional well light options to ensure success on every project. Constructed with heavy duty cast 316 stainless steel. Mounting sleeve included.



**15710 SS**  
FLARE LED SMALL  
QUAD-DIRECTIONAL  
WELL LIGHT



**15712 SS**  
FLARE LED LARGE  
UNI-DIRECTIONAL  
WELL LIGHT



**15740 SS**  
FLARE LED SMALL  
QUAD-DIRECTIONAL  
WELL LIGHT



**15742 SS**  
FLARE LED LARGE  
UNI-DIRECTIONAL  
WELL LIGHT

## TILT

Tilt's modern integrated LED wall light is available in either round or square options with cast 316 stainless steel housing and clear glass to cast a warm glow.



**15252 SS**  
TILT LED ROUND  
WALL LIGHT

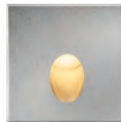

**15242 SS**  
TILT LED SQUARE  
WALL LIGHT

## DASH

Dash LED brick lights deliver sleek style, safety and security in a powerful package. Available in small and large sizes, as well as louvered versions. Dash has cast 316 stainless steel front equipped with frosted glass for soft illumination.



**15334 SS**  
DASH LED SMALL  
LOUVERED  
BRICK LIGHT



**15335 SS**  
DASH LED LARGE  
LOUVERED  
BRICK LIGHT



**15344 SS**  
DASH LED SMALL  
BRICK LIGHT



**15345 SS**  
DASH LED LARGE  
BRICK LIGHT



# LANDSCAPE LIGHTING TECHNIQUES

Every need-to-know method for lighting up the night

## SILHOUETTING

Also called backlighting, silhouetting is used to dramatize an interesting shaped object.

**CREATING THIS EFFECT :** A spot light is placed between the tree and the front of the home. The spot light is aimed at the front of the home creating a dramatic silhouette of the tree.



## WALL WASHING

Wall washing is a technique that refers to the general illumination of a wall or surface.

**CREATING THIS EFFECT :** Spot lights are placed along the front of the home to create a soft wash of light.



## SHADOWING

Shadowing is an effect created by placing a light source in front of an object and projecting a shadow onto a surface behind the object.

**CREATING THIS EFFECT :** Spot lights are placed directly in front of the tall bushes, producing shadows which are projected on the home's face, creating an interesting and inviting façade.



## UPLIGHTING

Uplighting is illuminating an area, surface or object from below to create a focal point in the landscape.

**CREATING THIS EFFECT :** A spot light is aimed at the tree in the foreground while the front of the home remains relatively dark.





## GRAZING

Grazing emphasizes a textured surface (such as a tree trunk, a stone wall, climbing ivy, etc.) by placing a light source within one foot of that surface and aiming the light beam parallel to that surface.

**CREATING THIS EFFECT :** Spot lights are placed beneath each stone pillar to create dimension, complementing the home's entryway.

## DECK + PATIO LIGHTING

Step, brick and hardscape lighting can be used in masonry and wood constructions. These fixtures are specifically designed to provide safety and accent lighting while creating a warm atmosphere.

**CREATING THIS EFFECT :** A surface-mounted deck sconce is placed on the wall above each step to illuminate a safe entryway to the deck. A hardscape fixture under the bench, coupled with deck sconces mounted to the corner posts create a soft glow.



## INDICATOR LIGHTING

Indicator lighting has numerous advantages to enhancing hard-to-light areas like driveways after dark. These heavy-duty fixtures are a low-profile, effective and modern solution.

**CREATING THIS EFFECT :** By installing recessed indicator lights into the concrete, they are safely anchored in place and can be added onto any existing low voltage landscape lighting system or installed with a new system.



## STEP LIGHTING

Step and brick lights can be used in masonry and wood constructions. These fixtures are designed to safely illuminate stairways and walkways.

**CREATING THIS EFFECT :** The steps are gently illuminated leading up to the doorway to ensure safety.



## PATH LIGHTING

Path and area lighting is used to enhance dynamic landscaping elements such as flower beds, shrubbery and borders while safely illuminating pathways.

**CREATING THIS EFFECT :** Path lights are staggered around the walkway to create pools of light that illuminate a safe passage to the home's entrance.





ATLANTIS 1518 CD-LL, PAGE 44

# OUTDOOR LIVING 101™

[FOLD OUT FOR A FULL VIEW >](#)

## 1 SPOT LIGHTS

Spot lights are the go-to fixture to highlight elements of your landscape that add the most visual appeal, such as foliage, trees and architectural elements. Hinkley offers a wide range of spot lights to fit any need.

## 2 PIER + POST MOUNT LANTERNS

Available in both 12v and 120v, pier mounts are incredibly versatile and designed to deliver the benefits of wall mount lanterns. When added to the entrance of driveways, decks or pathways, their presence transforms routine, high-traffic areas to a sophisticated, welcoming and well-lit environment. Many of Hinkley's pier mounts coordinate with hanging or wall-mounted lanterns, as well as path lighting, to create a cohesive property.

## 3 LUNA STEP LIGHTS

Available in 12V and 120V and a variety of colors (both double and single gang), the Luna Step Light is a versatile way to safely illuminate areas of foot traffic both indoors and out. Also fully dimmable, these fixtures allow customization of light output with only 4w of power consumption.

## 4 OUTDOOR PENDANTS + CHANDELIERS

Available in both 12v and 120v, exterior pendants and hanging lanterns can be used as a lighting source to illuminate and accent an outdoor dining space. A general guideline to follow is the same as interior pendants, which is for the bottom of the fixture to sit 28"-34" above the table.

## 5 OUTDOOR LANTERNS

Available in both 12v and 120v, lanterns mounted at a point of entry to the home provide safety, security, and a welcoming decorative element.

**ONE LANTERN** should measure about  $\frac{1}{3}$  the height of your door.

**TWO LANTERNS** should measure about  $\frac{1}{4}$  the height of the door. In all cases, the center of the light source should rest about 66" above the threshold.

## 6 OUTDOOR FANS

Wet-rated fans are a must in any area exposed to the elements. Spaces like covered porches and sunrooms, where condensation or high humidity are factors, also benefit from outdoor fans. Hinkley Fans allow customization on both the aesthetic and operational elements to jazz up the look and usability for the coolest solution to outdoor living spaces.

## 7 PATH LIGHTING

Path lighting is the perfect way to add style and safety to a walkway. Lights should be placed about 6' apart from one another, and staggered on either side of the path. Consider the light output of your fixtures to determine spacing that keeps the light from overlapping.

## 8 TRANSFORMER

Transformers convert your 120-volt household current to 12-volt. Calculate the total lamp wattage, or VA for LED, that your system requires and choose a transformer powerful enough to handle the total wattage/VA with extra capacity.

**EXTERIOR INSTALLATION** on the side or back of the home must be mounted 12" from the ground next to an outlet.

**INTERIOR INSTALLATION** such as in a basement, garage or shed must be listed for that application. UL code also requires an additional plate to guard against fire and conduit must be used when running wiring through an interior wall.

## 9 SHADOWING

Shadowing is an effect created by placing a light source, often a spot light, in front of an object and projecting a shadow onto a surface behind the object, such as the shadow of a tree onto a home's façade.





A COMPLETE GUIDE TO  
PLANNING AND PLACING  
OUTDOOR LIGHTING  
FIXTURES TO ACCENT  
YOUR PROPERTY AND  
HIGHLIGHT YOUR HOME.

**1**  
**SPOT LIGHTS**  
Accent Lighting  
Pages 22, 88

**3**  
**LUNA STEP LIGHTS**  
Pages 69, 93

**2**  
**PIER + POST MOUNT LANTERNS**  
For more styles,  
visit [Hinkley.com](http://Hinkley.com)

**4**  
**OUTDOOR PENDANTS + CHANDELIERS**  
For more styles,  
visit [Hinkley.com](http://Hinkley.com)

**5**  
**OUTDOOR LANTERNS**  
For more styles,  
visit [Hinkley.com](http://Hinkley.com)





TERNS

6

### OUTDOOR FANS

For more styles, visit [Hinkley.com](http://Hinkley.com)

7

### PATH LIGHTING

Pages 31, 87

8

### TRANSFORMERS

Page 104

9

### SHADOWING

Landscape Lighting Techniques, Page 6



# WALK RIGHT UP

LIGHTING THE WAY TO SAFETY

---

In addition to providing a luminous glow to the rustic outdoors, exterior lighting is often installed to increase safety outside the home. Let's shed some light on how to increase safety with hardscape and pathway lights!



HARDSCAPE LIGHTING

Hardscape lighting for deck, step and patio applications are specifically designed with safety in mind, and can be installed into masonry and wood constructions. For example, to illuminate stairs leading up to an entry way, a surface mounted hardscape light, such as Hinkley's Nuvi, can be placed under each step.

**F.Y.I.**

SAFETY LIGHTING & SECURITY LIGHTING ARE NOT THE SAME, ALTHOUGH THE TWO SHOULD WORK IN UNISON TO PROVIDE ULTIMATE PROTECTION FOR THE HOME.



PATH LIGHTING

Path lighting is used in a variety of diverse applications, but its most beneficial effect is safety. For the best results, stagger path lights to create pools of light that illuminate walkways, such as paths leading up to the front door. Path lighting can also enhance dynamic landscaping elements such as flower beds and shrubbery.

**BONUS!** Here, these Atlantis path lights provide both effects – safety and charm.



# HIGH FIVE

LET'S FACE IT: your wish list of home improvement projects is probably endless and most likely, focused on interior areas. But upgrading the outside is just as important!

LET'S TAKE A LOOK AT THE TOP 5 ADVANTAGES OF LIGHTING UP YOUR LANDSCAPE:



- 1 FLEXIBILITY** : You can start slowly and gradually add in more lighting features as your time, budget or exterior space allow—it's all in your hands!
- 2 INCREASED SECURITY** : Eliminate the dark areas of your home's exterior for added safety.
- 3 EXTEND YOUR LIVING SPACE** : Crafting a well-lit outdoor living area creates a multi-dimensional home that can be enjoyed day and night.
- 4 ECO-EFFICIENCY** : LED technology is the backbone of any lighting plan and will provide long-term cost-savings and almost zero maintenance.
- 5 IMPROVED HOME VALUE** : Well-designed landscape lighting will reinforce aesthetic appeal and make your home look more captivating.



A photograph of a modern building's exterior at dusk. The building features a mix of materials: light-colored stone blocks on the left, dark horizontal metal slats on the upper left, and vertical dark brown metal slats on the right. A glass-enclosed entrance is visible in the center. In the foreground, a concrete walkway is illuminated by several black, rectangular outdoor lighting fixtures. The sky is dark, and the interior lights of the building are on, creating a warm glow.

# TALK OF THE BLOCK:

## COORDINATE & COMPLEMENT FOR A WINNING COMBINATION

For a put-together property, we recommend reinforcing a building's architectural elements with coordinating path lights and exterior lanterns. With a bit of pre-planning, this can make your residence or commercial building stand out from all the others. Hinkley's outdoor product experts meticulously monitor building trends, and then design and pair styles to create a wide variety of matching path lights and lanterns. This unique process ensures exceptional exterior lighting plans that guarantee curb appeal and value, while creating a fabulous façade.



# COORDINATE + COMPLEMENT

To help you complete your lighting vision in style, Hinkley offers a wide variety of outdoor lantern families that coordinate with our landscape lighting designs. For more details see Hinkley's outdoor catalog or visit us at [Hinkley.com](http://Hinkley.com).

## ATLANTIS™

ATLANTIS PATH LIGHTS, PAGE 44  
ATLANTIS LANTERNS, VISIT [HINKLEY.COM](http://HINKLEY.COM)



## FOUNDRY™

FOUNDRY PATH LIGHTS, PAGE 43  
FOUNDRY LANTERNS, VISIT [HINKLEY.COM](http://HINKLEY.COM)



## ATWELL™

ATWELL PATH LIGHTS, PAGE 43  
ATWELL LANTERNS, VISIT [HINKLEY.COM](http://HINKLEY.COM)



## FREEPORT™

FREEPORT PATH LIGHTS, PAGE 38  
FREEPORT LANTERNS, VISIT [HINKLEY.COM](http://HINKLEY.COM)



## CARSON™

CARSON PATH LIGHT, PAGE 51  
CARSON LANTERNS, VISIT [HINKLEY.COM](http://HINKLEY.COM)



## HARBOR™

HARBOR PATH LIGHTS, PAGE 51  
HARBOR LANTERNS, VISIT [HINKLEY.COM](http://HINKLEY.COM)



## LUNA™

LUNA BOLLARDS, PAGE 33  
LUNA STEP LIGHTS, PAGE 68  
LUNA LANTERNS, VISIT HINKLEY.COM



## SATURN™

SATURN PATH LIGHTS, PAGE 50  
SATURN LANTERNS, VISIT HINKLEY.COM



## PLANTATION™

PLANTATION PATH LIGHT, PAGE 52  
PLANTATION LANTERNS, VISIT HINKLEY.COM



## SHELTER™

SHELTER BOLLARDS, PAGE 90  
PATH LIGHTS, PAGE 50  
SHELTER LANTERNS, VISIT HINKLEY.COM



## RALEY™

RALEY PATH LIGHTS, PAGE 52  
RALEY LANTERNS, VISIT HINKLEY.COM



## TAPER™

TAPER BOLLARDS, PAGE 90  
TAPER DECK LIGHTS, PAGE 64  
TAPER STEP LIGHTS, PAGE 66  
TAPER LANTERNS, VISIT HINKLEY.COM



### MAKE A COHESIVE STYLE STATEMENT!

SEE HINKLEY'S FULL LINE OUTDOOR CATALOG  
FOR COORDINATING OUTDOOR LANTERNS





## DESIGN SPOTLIGHT: FOUNDRY

Inspired by a lighting industry staple – the barn light - Foundry features a practical outdoor lighting solution combined with a bold style statement. The simple, understated form creates a vintage aesthetic for both inside and outside spaces while offering mix and match options that customize the look. Foundry is available in a Museum Bronze, Gloss White, and Textured Black.

**HINKLEY TIP:** For more expert advice and inspiration on how to select the best exterior lighting styles, check out [Hinkley.com/Blog](https://www.hinkley.com/blog).

FOUNDRY 10483 TK, HINKLEY.COM





# ACCENT LIGHTING



REX PATH LIGHTS 1534 TK, PAGE 49  
SPOT LIGHTS 1536 BZ, PAGE 22



THE LED ACCENT LIGHTING SYSTEM FOR THOSE WHO SEEK  
SUPERIOR FORM, FUNCTION AND THOUGHTFUL DESIGN.



# LumaCORE™

THE LUMACORE™ SYSTEM FROM HINKLEY IS SPECIFICALLY DESIGNED TO GIVE THE USER FULL CONTROL. WITH THREE LENSES INCLUDED, TWO LIGHT COLOR CHOICES AND FOUR BRIGHTNESS OPTIONS, LUMACORE™ HAS THE ABILITY TO PRODUCE THE LIGHTING RESULTS YOU WANT, BACKED BY OUR LIFETIME GUARANTEE.

## EXPERTLY ENGINEERED TO WITHSTAND THE ELEMENTS



### HEAT

Internal heat produced by bulbs combined with high atmospheric temperatures can cause accent lighting to burn out. LumaCore™ is engineered to perfectly fit the fixture for the most effective heat transfer.



### WATER

Accent lighting can fail when a fixture isn't properly sealed, allowing rain and condensation to destroy the internal components.

LumaCore™ fixtures effectively keep water out with two o-ring channels and a self-draining 10° angled spot light lens.



### SNOW + ICE

Extreme weather conditions can prevent accent lighting from functioning properly by causing component failure and blocking light output.

The LumaCore™ design has exceptional heat transfer with the ability to melt snow and ice.



### IMPACT

Landscape maintenance and outdoor activity can dislodge or damage lighting fixtures. Our robust spot and well light construction is designed to absorb impact, extending the life of the product.



**SEAMLESS PLUG-IN DESIGN**

Explore the expert engineering components of the LumaCore™ System, all designed to work as one for a maintenance-free long life. Easy upgrades and full user control fit every accent lighting application.



SPOT LIGHT

- ① LED CORE
- ② INTERCHANGEABLE LENSES
- ③ BI-PIN SOCKET



WELL LIGHT

**INSIDE THE LUMACORE™ SYSTEM**



**3W, 5W, 8W OR 12W | 2700K OR 3000K**  
 The LED core means no maintenance: easy plug-in design, built to withstand the elements, no bulbs to replace and the guarantee of a lifetime warranty.

+



**20° SPOT**  
 Ideal beam spread for highlighting tall trees, architectural features and flag poles



**40° FLOOD**  
 Most common beam spread for up lighting and wall washing



**60° WIDE FLOOD**  
 Ideal beam spread for lighting canopies of trees, large structures and wall washing

**INDUSTRY LEADING LIFETIME WARRANTY**

Like all Hinkley Landscape Lighting products, the LumaCore™ LED Core is manufactured under the highest standards of quality and workmanship. It is expertly engineered to withstand the elements and is intentionally designed for ease of use. LumaCore™ LED Core is backed by an industry leading lifetime warranty.

LUMACORE™ LED CORE  
**LIFETIME WARRANTY**

HARDY ISLAND™ COLLECTION  
**LIFETIME WARRANTY**

CAST ALUMINUM FIXTURES  
 AND STANDARD HOUSING  
**5 YEAR WARRANTY**





## LumaCORE™ SPOT LIGHTS



**1536 MZ**  
HARDY ISLAND™  
SPOT LIGHT  
2½" DIA. SHROUD  
5¾" W, 3¼" H



**1536 BZ**  
SPOT LIGHT  
2½" DIA. SHROUD  
5¾" W, 3¼" H



**1536 SK**  
SPOT LIGHT  
2½" DIA. SHROUD  
5¾" W, 3¼" H

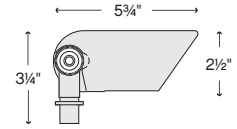

**1535 MZ**  
HARDY ISLAND™  
SPOT LIGHT  
2½" DIA. SHROUD  
9¾" W, 3¼" H



**1535 BZ**  
SPOT LIGHT  
2½" DIA. SHROUD  
9¾" W, 3¼" H

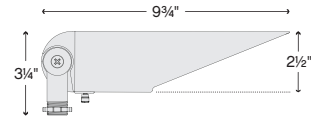

### HARDY ISLAND CAST BRASS SPOT LIGHTS

LED ITEM	LED ENGINE (INCLUDED)	MAX WATTAGE / VOLT AMPS	LUMENS	COLOR TEMP.	HALOGEN EQUIV.	LIFESPAN	FINISH	CONSTRUCTION	LENS
<b>1536 MZ-3W27K</b>	27G3SE-20	3w / 3.2VA	260	2700K	25w	60,000 hrs	Matte Bronze	Solid Brass	Clear
<b>1536 MZ-5W27K</b>	27G3SE-35	5w / 5.3VA	350	2700K	35w	60,000 hrs	Matte Bronze	Solid Brass	Clear
<b>1536 MZ-8W27K</b>	27G3SE-50	8w / 7.8VA	475	2700K	45w	60,000 hrs	Matte Bronze	Solid Brass	Clear
<b>1536 MZ-12W27K</b>	27G3SE-75	12w / 12.4VA	750	2700K	60w	40,000 hrs	Matte Bronze	Solid Brass	Clear
<b>1536 MZ-3W3K</b>	00G3SE-20	3w / 3.2VA	260	3000K	25w	60,000 hrs	Matte Bronze	Solid Brass	Clear
<b>1536 MZ-5W3K</b>	00G3SE-35	5w / 5.3VA	350	3000K	35w	60,000 hrs	Matte Bronze	Solid Brass	Clear
<b>1536 MZ-8W3K</b>	00G3SE-50	8w / 7.8VA	475	3000K	45w	60,000 hrs	Matte Bronze	Solid Brass	Clear
<b>1536 MZ-12W3K</b>	00G3SE-75	12w / 12.4VA	750	3000K	60w	40,000 hrs	Matte Bronze	Solid Brass	Clear

A wiring kit is supplied. Photometrics for spot lights are based off engine photometrics. See page 111. For accessories, see page 108. For transformers, see page 104. For non-integrated base item, see page 22.

## BRONZE CAST ALUMINUM SPOT LIGHTS

 LED ITEM	LED ENGINE (INCLUDED)	MAX WATTAGE / VOLT AMPS	LUMENS	COLOR TEMP.	HALOGEN EQUIV.	LIFESPAN	FINISH	CONSTRUCTION	LENS
1536 BZ-3W27K	27G3SE-20	3w / 3.2VA	260	2700K	25w	60,000 hrs	Bronze	Cast Aluminum	Clear
1536 BZ-5W27K	27G3SE-35	5w / 5.3VA	350	2700K	35w	60,000 hrs	Bronze	Cast Aluminum	Clear
1536 BZ-8W27K	27G3SE-50	8w / 7.8VA	475	2700K	45w	60,000 hrs	Bronze	Cast Aluminum	Clear
1536 BZ-12W27K	27G3SE-75	12w / 12.4VA	750	2700K	60w	40,000 hrs	Bronze	Cast Aluminum	Clear
1536 BZ-3W3K	00G3SE-20	3w / 3.2VA	260	3000K	25w	60,000 hrs	Bronze	Cast Aluminum	Clear
1536 BZ-5W3K	00G3SE-35	5w / 5.3VA	350	3000K	35w	60,000 hrs	Bronze	Cast Aluminum	Clear
1536 BZ-8W3K	00G3SE-50	8w / 7.8VA	475	3000K	45w	60,000 hrs	Bronze	Cast Aluminum	Clear
1536 BZ-12W3K	00G3SE-75	12w / 12.4VA	750	3000K	60w	40,000 hrs	Bronze	Cast Aluminum	Clear

A wiring kit is supplied. Photometrics for spot lights are based off engine photometrics. See page 111. For accessories, see page 108. For transformers, see page 104. For non-integrated base item, see page 22. For warranty details, see Hinkley.com.

## SATIN BLACK CAST ALUMINUM SPOT LIGHTS

 LED ITEM	LED ENGINE (INCLUDED)	MAX WATTAGE / VOLT AMPS	LUMENS	COLOR TEMP.	HALOGEN EQUIV.	LIFESPAN	FINISH	CONSTRUCTION	LENS
1536 SK-3W27K	27G3SE-20	3w / 3.2VA	260	2700K	25w	60,000 hrs	Satin Black	Cast Aluminum	Clear
1536 SK-5W27K	27G3SE-35	5w / 5.3VA	350	2700K	35w	60,000 hrs	Satin Black	Cast Aluminum	Clear
1536 SK-8W27K	27G3SE-50	8w / 7.8VA	475	2700K	45w	60,000 hrs	Satin Black	Cast Aluminum	Clear
1536 SK-12W27K	27G3SE-75	12w / 12.4VA	750	2700K	60w	40,000 hrs	Satin Black	Cast Aluminum	Clear
1536 SK-3W3K	00G3SE-20	3w / 3.2VA	260	3000K	25w	60,000 hrs	Satin Black	Cast Aluminum	Clear
1536 SK-5W3K	00G3SE-35	5w / 5.3VA	350	3000K	35w	60,000 hrs	Satin Black	Cast Aluminum	Clear
1536 SK-8W3K	00G3SE-50	8w / 7.8VA	475	3000K	45w	60,000 hrs	Satin Black	Cast Aluminum	Clear
1536 SK-12W3K	00G3SE-75	12w / 12.4VA	750	3000K	60w	40,000 hrs	Satin Black	Cast Aluminum	Clear

A wiring kit is supplied. Photometrics for spot lights are based off engine photometrics. See page 111. For accessories, see page 108. For transformers, see page 104. For non-integrated base item, see page 22. For warranty details, see Hinkley.com.

HARDY ISLAND  CAST BRASS SPOT LIGHTS

 LED ITEM	LED ENGINE (INCLUDED)	MAX WATTAGE / VOLT AMPS	LUMENS	COLOR TEMP.	HALOGEN EQUIV.	LIFESPAN	FINISH	CONSTRUCTION	LENS
1535 MZ-3W27K	27G3SE-20	3w / 3.2VA	260	2700K	25w	60,000 hrs	Matte Bronze	Solid Brass	Clear
1535 MZ-5W27K	27G3SE-35	5w / 5.3VA	350	2700K	35w	60,000 hrs	Matte Bronze	Solid Brass	Clear
1535 MZ-8W27K	27G3SE-50	8w / 7.8VA	475	2700K	45w	60,000 hrs	Matte Bronze	Solid Brass	Clear
1535 MZ-12W27K	27G3SE-75	12w / 12.4VA	750	2700K	60w	40,000 hrs	Matte Bronze	Solid Brass	Clear
1535 MZ-3W3K	00G3SE-20	3w / 3.2VA	260	3000K	25w	60,000 hrs	Matte Bronze	Solid Brass	Clear
1535 MZ-5W3K	00G3SE-35	5w / 5.3VA	350	3000K	35w	60,000 hrs	Matte Bronze	Solid Brass	Clear
1535 MZ-8W3K	00G3SE-50	8w / 7.8VA	475	3000K	45w	60,000 hrs	Matte Bronze	Solid Brass	Clear
1535 MZ-12W3K	00G3SE-75	12w / 12.4VA	750	3000K	60w	40,000 hrs	Matte Bronze	Solid Brass	Clear

A wiring kit is supplied. Photometrics for spot lights are based off engine photometrics. See page 111. For accessories, see page 108. For transformers, see page 104. For non-integrated base item, see page 22. For warranty details, see Hinkley.com.

## BRONZE CAST ALUMINUM SPOT LIGHTS

 LED ITEM	LED ENGINE (INCLUDED)	MAX WATTAGE / VOLT AMPS	LUMENS	COLOR TEMP.	HALOGEN EQUIV.	LIFESPAN	FINISH	CONSTRUCTION	LENS
1535 BZ-3W27K	27G3SE-20	3w / 3.2VA	260	2700K	25w	60,000 hrs	Bronze	Cast Aluminum	Clear
1535 BZ-5W27K	27G3SE-35	5w / 5.3VA	350	2700K	35w	60,000 hrs	Bronze	Cast Aluminum	Clear
1535 BZ-8W27K	27G3SE-50	8w / 7.8VA	475	2700K	45w	60,000 hrs	Bronze	Cast Aluminum	Clear
1535 BZ-12W27K	27G3SE-75	12w / 12.4VA	750	2700K	60w	40,000 hrs	Bronze	Cast Aluminum	Clear
1535 BZ-3W3K	00G3SE-20	3w / 3.2VA	260	3000K	25w	60,000 hrs	Bronze	Cast Aluminum	Clear
1535 BZ-5W3K	00G3SE-35	5w / 5.3VA	350	3000K	35w	60,000 hrs	Bronze	Cast Aluminum	Clear
1535 BZ-8W3K	00G3SE-50	8w / 7.8VA	475	3000K	45w	60,000 hrs	Bronze	Cast Aluminum	Clear
1535 BZ-12W3K	00G3SE-75	12w / 12.4VA	750	3000K	60w	40,000 hrs	Bronze	Cast Aluminum	Clear

A wiring kit is supplied. Photometrics for spot lights are based off engine photometrics. See page 111. For accessories, see page 108. For transformers, see page 104. For non-integrated base item, see page 22. For warranty details, see Hinkley.com.



# LumaCORE™ WELL LIGHTS



## FEATURES + BENEFITS

- AVAILABLE IN 3W, 5W, 8W, AND 12W LUMACORE LED
- BURIAL SLEEVE AND CONCRETE KIT INCLUDED
- OPTIONAL HEX LOUVER LENS AVAILABLE, 0037HL
- LAMP TILT +/- 20°
- FLAT TOP-DRIVE OVER RATED

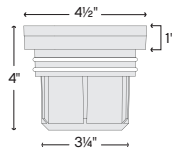

Well lights come with a PVC constructed concrete pour kit. Includes a dense foam cap to prevent concrete from entering.

4 1/8" DIA., 5" H

**15702 BZ**  
FLAT TOP WELL LIGHT  
4 1/2" DIA., 4" H, 1" H TOP  
3 1/2" DIA. BASE

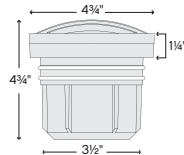

**15705 BZ**  
GRILL TOP WELL LIGHT  
4 3/4" DIA., 4 3/4" H, 1 1/4" H TOP  
3 1/2" DIA. BASE

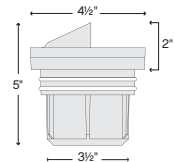

**15708 BZ**  
SHIELDED WELL LIGHT  
4 1/2" DIA., 5" H, 2" H TOP  
3 1/2" DIA. BASE





FLAT TOP WELL LIGHTS\*

LED ITEM	LED ENGINE (INCLUDED)	MAX WATTAGE / VOLT AMPS	LUMENS	COLOR TEMP.	HALOGEN EQUIV.	LIFESPAN	FINISH	CONSTRUCTION	LENS
15702 BZ-3W27K	27G3SE-20	3w / 3.2VA	260	2700K	25w	60,000 hrs	Bronze	Cast Aluminum	Clear
15702 BZ-5W27K	27G3SE-35	5w / 5.3VA	350	2700K	35w	60,000 hrs	Bronze	Cast Aluminum	Clear
15702 BZ-8W27K	27G3SE-50	8w / 7.8VA	475	2700K	45w	60,000 hrs	Bronze	Cast Aluminum	Clear
15702 BZ-12W27K	27G3SE-75	12w / 12.4VA	750	2700K	60w	40,000 hrs	Bronze	Cast Aluminum	Clear
15702 BZ-3W3K	00G3SE-20	3w / 3.2VA	260	3000K	25w	60,000 hrs	Bronze	Cast Aluminum	Clear
15702 BZ-5W3K	00G3SE-35	5w / 5.3VA	350	3000K	35w	60,000 hrs	Bronze	Cast Aluminum	Clear
15702 BZ-8W3K	00G3SE-50	8w / 7.8VA	475	3000K	45w	60,000 hrs	Bronze	Cast Aluminum	Clear
15702 BZ-12W3K	00G3SE-75	12w / 12.4VA	750	3000K	60w	40,000 hrs	Bronze	Cast Aluminum	Clear

\*Flat top well lights are drive over rated up to 4,500 lbs. A wiring kit is supplied. Photometrics for well lights are based off engine photometrics. See page 111. For accessories, see page 108. For transformers, see page 104. For non-integrated base item, see page 26. For warranty details, see Hinkley.com.

GRILL TOP WELL LIGHTS

LED ITEM	LED ENGINE (INCLUDED)	MAX WATTAGE / VOLT AMPS	LUMENS	COLOR TEMP.	HALOGEN EQUIV.	LIFESPAN	FINISH	CONSTRUCTION	LENS
15705 BZ-3W27K	27G3SE-20	3w / 3.2VA	260	2700K	25w	60,000 hrs	Bronze	Cast Aluminum	Clear
15705 BZ-5W27K	27G3SE-35	5w / 5.3VA	350	2700K	35w	60,000 hrs	Bronze	Cast Aluminum	Clear
15705 BZ-8W27K	27G3SE-50	8w / 7.8VA	475	2700K	45w	60,000 hrs	Bronze	Cast Aluminum	Clear
15705 BZ-12W27K	27G3SE-75	12w / 12.4VA	750	2700K	60w	40,000 hrs	Bronze	Cast Aluminum	Clear
15705 BZ-3W3K	00G3SE-20	3w / 3.2VA	260	3000K	25w	60,000 hrs	Bronze	Cast Aluminum	Clear
15705 BZ-5W3K	00G3SE-35	5w / 5.3VA	350	3000K	35w	60,000 hrs	Bronze	Cast Aluminum	Clear
15705 BZ-8W3K	00G3SE-50	8w / 7.8VA	475	3000K	45w	60,000 hrs	Bronze	Cast Aluminum	Clear
15705 BZ-12W3K	00G3SE-75	12w / 12.4VA	750	3000K	60w	40,000 hrs	Bronze	Cast Aluminum	Clear

A wiring kit is supplied. Photometrics for well lights are based off engine photometrics. See page 111. For accessories, see page 108. For transformers, see page 104. For non-integrated base item, see page 26. For warranty details, see Hinkley.com.

SHIELDED WELL LIGHTS

LED ITEM	LED ENGINE (INCLUDED)	MAX WATTAGE / VOLT AMPS	LUMENS	COLOR TEMP.	HALOGEN EQUIV.	LIFESPAN	FINISH	CONSTRUCTION	LENS
15708 BZ-3W27K	27G3SE-20	3w / 3.2VA	260	2700K	25w	60,000 hrs	Bronze	Cast Aluminum	Clear
15708 BZ-5W27K	27G3SE-35	5w / 5.3VA	350	2700K	35w	60,000 hrs	Bronze	Cast Aluminum	Clear
15708 BZ-8W27K	27G3SE-50	8w / 7.8VA	475	2700K	45w	60,000 hrs	Bronze	Cast Aluminum	Clear
15708 BZ-12W27K	27G3SE-75	12w / 12.4VA	750	2700K	60w	40,000 hrs	Bronze	Cast Aluminum	Clear
15708 BZ-3W3K	00G3SE-20	3w / 3.2VA	260	3000K	25w	60,000 hrs	Bronze	Cast Aluminum	Clear
15708 BZ-5W3K	00G3SE-35	5w / 5.3VA	350	3000K	35w	60,000 hrs	Bronze	Cast Aluminum	Clear
15708 BZ-8W3K	00G3SE-50	8w / 7.8VA	475	3000K	45w	60,000 hrs	Bronze	Cast Aluminum	Clear
15708 BZ-12W3K	00G3SE-75	12w / 12.4VA	750	3000K	60w	40,000 hrs	Bronze	Cast Aluminum	Clear

A wiring kit is supplied. Photometrics for well lights are based off engine photometrics. See page 111. For accessories, see page 108. For transformers, see page 104. For non-integrated base item, see page 26. For warranty details, see Hinkley.com.



# LumaCORE™ WELL LIGHTS



## FEATURES + BENEFITS

- AVAILABLE IN 3W, 5W, 8W, AND 12W LUMACORE LED
- BURIAL SLEEVE AND CONCRETE KIT INCLUDED
- OPTIONAL HEX LOUVER LENS AVAILABLE, 0037HL
- LAMP TILT +/- 20°
- FLAT TOP-DRIVE OVER RATED

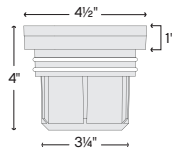

Well lights come with a PVC constructed concrete pour kit. Includes a dense foam cap to prevent concrete from entering.

4 1/8" DIA., 5" H

**15702 MZ**  
HARDY ISLAND™  
FLAT TOP WELL LIGHT  
4 1/2" DIA., 4" H, 1" H TOP  
3 1/2" DIA. BASE

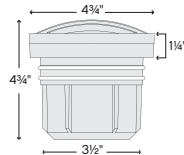

**15705 MZ**  
HARDY ISLAND™  
GRILL TOP WELL LIGHT  
4 3/4" DIA., 4 3/4" H, 1 1/4" H TOP  
3 1/2" DIA. BASE

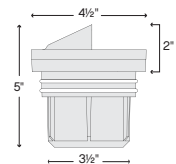

**15708 MZ**  
HARDY ISLAND™  
SHIELDED WELL LIGHT  
4 1/2" DIA., 5" H, 2" H TOP  
3 1/2" DIA. BASE



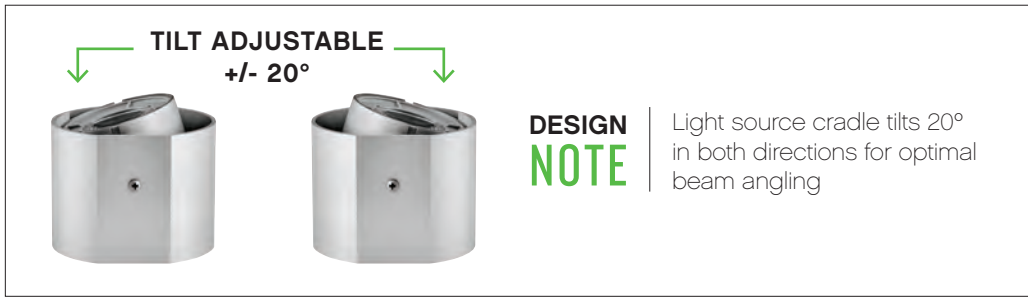

**HARDY ISLAND** **CAST BRASS FLAT TOP WELL LIGHTS\***

LED ITEM	LED ENGINE (INCLUDED)	MAX WATTAGE / VOLT AMPS	LUMENS	COLOR TEMP.	HALOGEN EQUIV.	LIFESPAN	FINISH	CONSTRUCTION	LENS
15702 MZ-3W27K	27G3SE-20	3w / 3.2VA	260	2700K	25w	60,000 hrs	Matte Bronze	Cast Brass**	Clear
15702 MZ-5W27K	27G3SE-35	5w / 5.3VA	350	2700K	35w	60,000 hrs	Matte Bronze	Cast Brass**	Clear
15702 MZ-8W27K	27G3SE-50	8w / 7.8VA	475	2700K	45w	60,000 hrs	Matte Bronze	Cast Brass**	Clear
15702 MZ-12W27K	27G3SE-75	12w / 12.4VA	750	2700K	60w	40,000 hrs	Matte Bronze	Cast Brass**	Clear
15702 MZ-3W3K	00G3SE-20	3w / 3.2VA	260	3000K	25w	60,000 hrs	Matte Bronze	Cast Brass**	Clear
15702 MZ-5W3K	00G3SE-35	5w / 5.3VA	350	3000K	35w	60,000 hrs	Matte Bronze	Cast Brass**	Clear
15702 MZ-8W3K	00G3SE-50	8w / 7.8VA	475	3000K	45w	60,000 hrs	Matte Bronze	Cast Brass**	Clear
15702 MZ-12W3K	00G3SE-75	12w / 12.4VA	750	3000K	60w	40,000 hrs	Matte Bronze	Cast Brass**	Clear

\*Flat top well lights are drive over rated up to 4,500 lbs. A wiring kit is supplied. Photometrics for well lights are based off engine photometrics. See page 111. For accessories, see pages 102-103. For transformers, see page 104. For non-integrated base item, see page 26. For warranty details, see Hinkley.com. \*\*Cover is Cast Brass and base is Aluminum.

**HARDY ISLAND** **CAST BRASS GRILL TOP WELL LIGHTS**

LED ITEM	LED ENGINE (INCLUDED)	MAX WATTAGE / VOLT AMPS	LUMENS	COLOR TEMP.	HALOGEN EQUIV.	LIFESPAN	FINISH	CONSTRUCTION	LENS
15705 MZ-3W27K	27G3SE-20	3w / 3.2VA	260	2700K	25w	60,000 hrs	Matte Bronze	Cast Brass*	Clear
15705 MZ-5W27K	27G3SE-35	5w / 5.3VA	350	2700K	35w	60,000 hrs	Matte Bronze	Cast Brass*	Clear
15705 MZ-8W27K	27G3SE-50	8w / 7.8VA	475	2700K	45w	60,000 hrs	Matte Bronze	Cast Brass*	Clear
15705 MZ-12W27K	27G3SE-75	12w / 12.4VA	750	2700K	60w	40,000 hrs	Matte Bronze	Cast Brass*	Clear
15705 MZ-3W3K	00G3SE-20	3w / 3.2VA	260	3000K	25w	60,000 hrs	Matte Bronze	Cast Brass*	Clear
15705 MZ-5W3K	00G3SE-35	5w / 5.3VA	350	3000K	35w	60,000 hrs	Matte Bronze	Cast Brass*	Clear
15705 MZ-8W3K	00G3SE-50	8w / 7.8VA	475	3000K	45w	60,000 hrs	Matte Bronze	Cast Brass*	Clear
15705 MZ-12W3K	00G3SE-75	12w / 12.4VA	750	3000K	60w	40,000 hrs	Matte Bronze	Cast Brass*	Clear

A wiring kit is supplied. Photometrics for well lights are based off engine photometrics. See page 111. For accessories, see page 108. For transformers, see page 104. For non-integrated base item, see page 26. For warranty details, see Hinkley.com. \*Cover is Cast Brass and base is Aluminum.

**HARDY ISLAND** **CAST BRASS SHIELDED WELL LIGHTS**

LED ITEM	LED ENGINE (INCLUDED)	MAX WATTAGE / VOLT AMPS	LUMENS	COLOR TEMP.	HALOGEN EQUIV.	LIFESPAN	FINISH	CONSTRUCTION	LENS
15708 MZ-3W27K	27G3SE-20	3w / 3.2VA	260	2700K	25w	60,000 hrs	Matte Bronze	Cast Brass*	Clear
15708 MZ-5W27K	27G3SE-35	5w / 5.3VA	350	2700K	35w	60,000 hrs	Matte Bronze	Cast Brass*	Clear
15708 MZ-8W27K	27G3SE-50	8w / 7.8VA	475	2700K	45w	60,000 hrs	Matte Bronze	Cast Brass*	Clear
15708 MZ-12W27K	27G3SE-75	12w / 12.4VA	750	2700K	60w	40,000 hrs	Matte Bronze	Cast Brass*	Clear
15708 MZ-3W3K	00G3SE-20	3w / 3.2VA	260	3000K	25w	60,000 hrs	Matte Bronze	Cast Brass*	Clear
15708 MZ-5W3K	00G3SE-35	5w / 5.3VA	350	3000K	35w	60,000 hrs	Matte Bronze	Cast Brass*	Clear
15708 MZ-8W3K	00G3SE-50	8w / 7.8VA	475	3000K	45w	60,000 hrs	Matte Bronze	Cast Brass*	Clear
15708 MZ-12W3K	00G3SE-75	12w / 12.4VA	750	3000K	60w	40,000 hrs	Matte Bronze	Cast Brass*	Clear

A wiring kit is supplied. Photometrics for well lights are based off engine photometrics. See page 111. For accessories, see page 108. For transformers, see page 104. For non-integrated base item, see page 26. For warranty details, see Hinkley.com. \*Cover is Cast Brass and base is Aluminum.



## MR16 LED SPOT LIGHTS



Choose your appropriate MR16 lamp. See page 114.



**1535 MZ**

HARDY ISLAND™  
MR16 SPOT LIGHT  
2 1/2" DIA. SHROUD  
9 3/4" W, 3 1/4" H



**1535 BZ**

MR16 SPOT LIGHT  
2 1/2" DIA. SHROUD  
9 3/4" W, 3 1/4" H

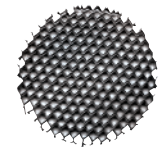

Anti-glare hex  
louvers available.  
See page 109.

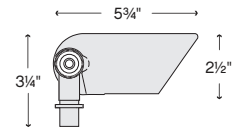

**1536 MZ**

HARDY ISLAND™  
MR16 SPOT LIGHT  
2 1/2" DIA. SHROUD  
5 3/4" W, 3 1/4" H



**1536 BZ**

MR16 SPOT LIGHT  
**1536 BZ-LL**  
4W MR16 LED SPOT LIGHT  
2 1/2" DIA. SHROUD  
5 3/4" W, 3 1/4" H

**1536 SK**

MR16 SPOT LIGHT  
**1536 SK-LL**  
4W MR16 LED SPOT LIGHT  
2 1/2" DIA. SHROUD  
5 3/4" W, 3 1/4" H

LED ITEM	LED LAMP (INCLUDED)	HALOGEN EQUIV.	ITEM	LED LAMP (NOT INCLUDED)	FINISH	CONSTRUCTION	LENS
			<b>1535 BZ</b>	MR16 6w LED (max)	Bronze	Cast Aluminum	Clear
			<b>1535 MZ</b>	MR16 6w LED (max)	Matte Bronze	Solid Brass	Clear
<b>1536 BZ-LL</b>	4w MR16 LED / 38°	35w	<b>1536 BZ</b>	MR16 6w LED (max)	Bronze	Cast Aluminum	Clear
			<b>1536 MZ</b>	MR16 6w LED (max)	Matte Bronze	Solid Brass	Clear
<b>1536 SK-LL</b>	4w MR16 LED / 38°	35w	<b>1536 SK</b>	MR16 6w LED (max)	Satin Black	Cast Aluminum	Clear

Photometrics for spot lights are based off lamp photometrics. See page 114. See page 114 for LED conversion lamps. A wiring kit and ground spike (0014 BZ, page 109) are supplied. For accessories, see page 108. For transformers, see page 104. For integrated LumaCORE product, see page 16.



HARDY ISLAND

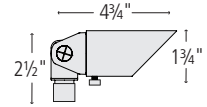
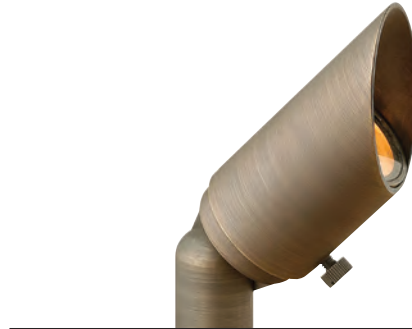

**16501 MZ**  
**16501 MZ-27K60**  
 HARDY ISLAND™  
 SPOT LIGHT  
 1 3/4" DIA. SHROUD  
 4 3/4" W, 2 1/2" H



**DESIGN NOTE** | 1536 is down light only



**1536 BZDN**  
 MR16 DOWN LIGHT  
 2 1/2" DIA. SHROUD  
 5 3/4" W, 3 1/4" H



**16507 MZ**  
**16507 MZ-27K60**  
 HARDY ISLAND™  
 SPOT LIGHT & STEM  
 1 3/4" DIA. SHROUD  
 4 3/4" W, 26 1/2" H



**DESIGN NOTE** | 16571 is oval in shape

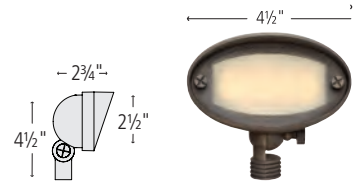

**16571 MZ-LL**  
 HARDY ISLAND™ SMALL  
 WALL WASH FLOOD LIGHT  
 4 1/2" W, 2 1/2" H SHROUD  
 2 3/4" W, 4 1/2" H



LED ITEM	LED LAMP (INCLUDED)	MAX WATTAGE / VOLT AMPS	HALOGEN EQUIV.	ITEM	LAMP (NOT INCLUDED)	FINISH	CONSTRUCTION	LENS
				<b>1536 BZDN</b>	MR16	Bronze	Cast Aluminum	Hex Louver*
<b>16501 MZ-27K60</b>	MR827K	2.5w / 4VA	35w	<b>16501 MZ</b>	MR11	Matte Bronze	Cast Brass	Clear
<b>16507 MZ-27K60</b>	MR827K	2.5w / 4VA	35w	<b>16507 MZ</b>	MR11	Matte Bronze	Cast Brass	Clear
<b>16571 MZ-LL</b>	EA-LMW-2.5W	2.5w / 3.8VA	25w			Matte Bronze	Cast Brass	Frosted

\*Includes Hex Louver lens for down light use only. Optional performance lenses available, see page 109. Photometrics for spot lights are based off lamp photometrics. See pages 114. A wiring kit and ground spike (0014 BZ, page 109) are supplied. For accessories, see page 108. For transformers, see page 104.



Choose your appropriate lamp. See page 114.

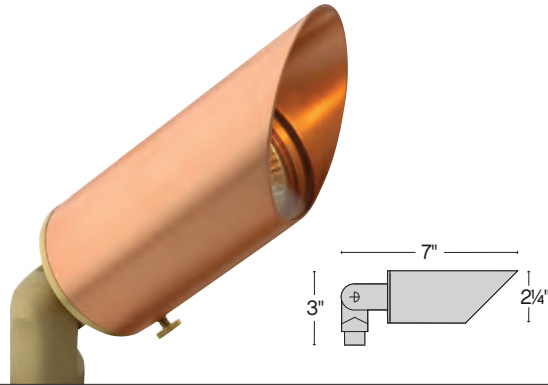

**1583 NC**  
MR16 COPPER SPOT LIGHT  
2 1/4" DIA. SHROUD  
7" W, 3" H

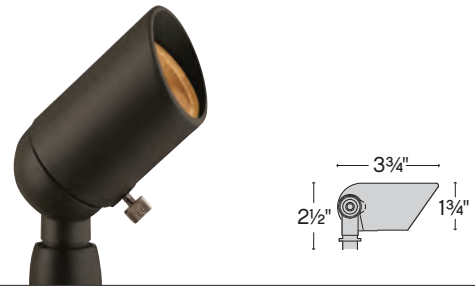

**1530 BZ**  
MR11 SPOT LIGHT  
1 3/4" DIA. SHROUD  
3 3/4" W, 2 1/2" H

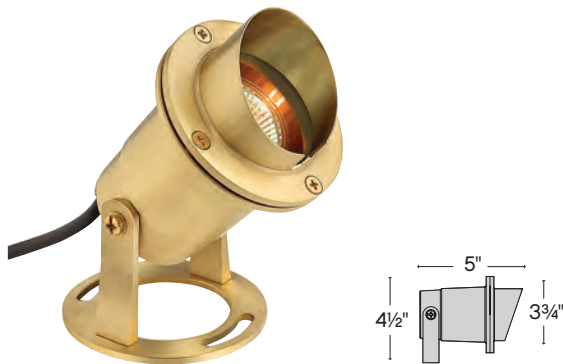

**1539 BS**  
MR16 BRASS SUBMERSIBLE  
POND LIGHT  
3 3/4" DIA. SHROUD  
5" W, 4 1/2" H



**1521 BZ**  
FLOOD LIGHT  
WITH FROSTED LENS  
5 1/2" W, 4" H SHROUD  
5" W, 6 1/4" H

ITEM	LAMP (NOT INCLUDED)	LED LAMP (NOT INCLUDED)	FINISH	CONSTRUCTION	LENS
1521 BZ	T4	T3 LED	Bronze	Cast Aluminum	Frosted
1530 BZ	MR11	MR827K	Bronze	Cast Aluminum	Clear
1539 BS	MR16	MR16 LED	Brass	Solid Brass	Clear
1583 NC	MR16	MR16 LED	Natural Copper	Copper and Brass	Clear

See Hinkley.com for photometric data. See page 114 for LED conversion lamps. A wiring kit and ground spike (0014 BZ, page 109) are supplied. For accessories, see page 108. For transformers, see page 104.







## MR16 LED WELL LIGHTS

**FEATURES + BENEFITS**

- ACCEPTS LED MR16 LAMPS
- LAMP TILT +/- 20°
- BURIAL SLEEVE AND CONCRETE KIT INCLUDED
- OPTIONAL HEX LOUVER LENS AVAILABLE, 0037HL

Well lights come with a PVC constructed concrete pour kit. Includes a dense foam cap to prevent concrete from entering.

4 1/8" DIA., 5" H

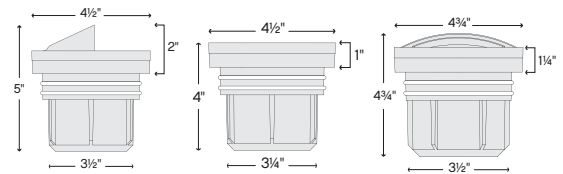

TILT ADJUSTABLE  
+/- 20°



**15702 BZ**  
FLAT TOP WELL LIGHT  
4 1/2" DIA., 4" H, 1" H TOP  
3 1/2" DIA. BASE

**15702 MZ**  
HARDY ISLAND™  
FLAT TOP WELL LIGHT  
4 1/2" DIA., 4" H, 1" H TOP  
3 1/2" DIA. BASE

**15705 BZ**  
GRILL TOP WELL LIGHT  
4 3/4" DIA., 4 3/4" H, 1 1/4" H TOP  
3 1/2" DIA. BASE

**15705 MZ**  
HARDY ISLAND™  
GRILL TOP WELL LIGHT  
4 3/4" DIA., 4 3/4" H, 1 1/4" H TOP  
3 1/2" DIA. BASE

ITEM	LED LAMP (NOT INCLUDED)	MAX LED WATTAGE	FINISH	CONSTRUCTION	LENS
15702 BZ*	MR16 LED	9w	Bronze	Aluminum	Clear
15705 BZ	MR16 LED	9w	Bronze	Aluminum	Clear
15708 BZ	MR16 LED	9w	Bronze	Aluminum	Clear
15702 MZ*	MR16 LED	9w	Matte Bronze	Cast Brass and Aluminum	Clear
15705 MZ	MR16 LED	9w	Matte Bronze	Cast Brass and Aluminum	Clear
15708 MZ	MR16 LED	9w	Matte Bronze	Cast Brass and Aluminum	Clear

\*15702 is drive over rated up to 4,500 lbs. A wiring kit is supplied. Photometrics for well lights are based off lamp photometrics. See pages 114. For accessories, see page 108. For transformers, see page 104. For integrated LumaCORE product, see page 18.









## MR16 LED WELL LIGHTS

Choose your appropriate MR16 lamp. See page 114.



Well lights come with an easy installation, anti-corrosion PVC burial sleeve. (Can install into concrete)



4 1/8" DIA., 5" H  
3" DIA. BASE

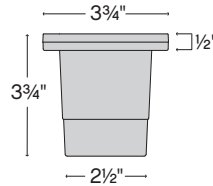

**16701 MZ**  
HARDY ISLAND™ FLAT TOP WELL LIGHT  
3 3/4" DIA., 3 3/4" H, 1/2" H TOP  
2 1/2" DIA. BASE

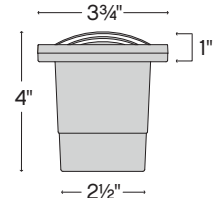

**16704 MZ**  
HARDY ISLAND™ GRILL TOP WELL LIGHT  
3 3/4" DIA., 4" H, 1" H TOP  
2 1/2" DIA. BASE



### DESIGN NOTE

16710 MZ features three openings

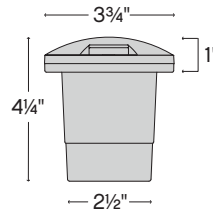

**16710 MZ**  
HARDY ISLAND™ DIRECTIONAL WELL LIGHT  
3 3/4" DIA., 4 1/4" H, 1" H TOP  
2 1/2" DIA. BASE

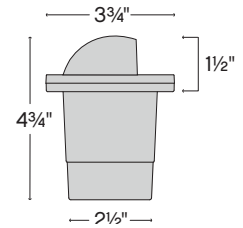

**16707 MZ**  
HARDY ISLAND™ EYEBROW WELL LIGHT  
3 3/4" DIA., 4 3/4" H, 1 1/2" H TOP  
2 1/2" DIA. BASE



ITEM	LED LAMP (NOT INCLUDED)	MAX LED WATTAGE	FINISH	CONSTRUCTION	LENS
16701 MZ	MR16	4w	Matte Bronze	Cast Brass	Clear
16704 MZ	MR16	4w	Matte Bronze	Cast Brass	Clear
16707 MZ	MR16	4w	Matte Bronze	Cast Brass	Frosted
16710 MZ	MR16	4w	Matte Bronze	Cast Brass	Clear

A wiring kit is supplied. See page 114 for LED conversion lamps. For accessories, see page 108. For transformers, see page 104.

**DESIGN NOTE**

One side is cut away for angling beam direction

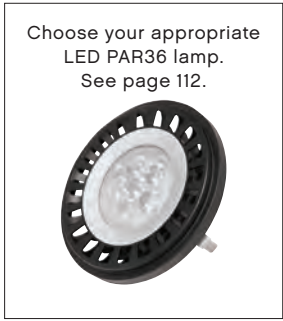
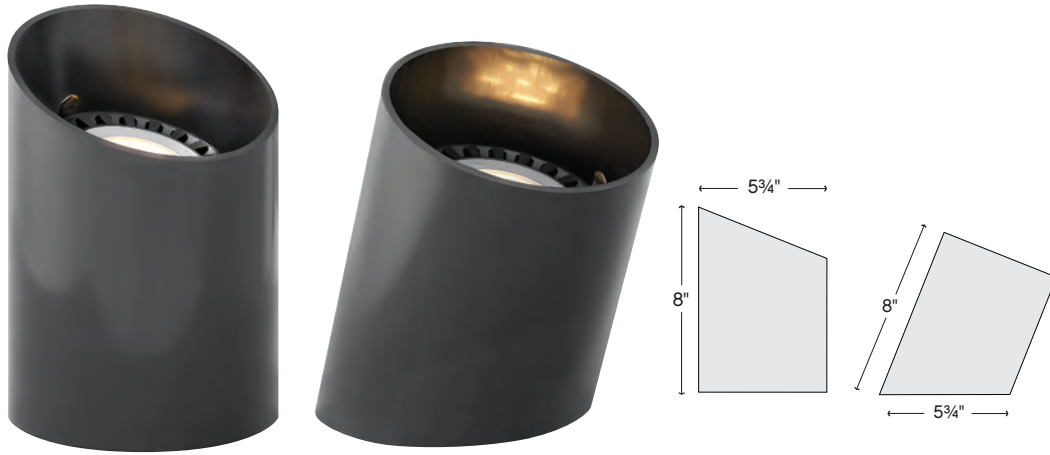

**1598 BK**  
REVERSIBLE PAR36 WELL LIGHT  
5 3/4" DIA., 8" H

TILT ADJUSTABLE  
+/- 20°

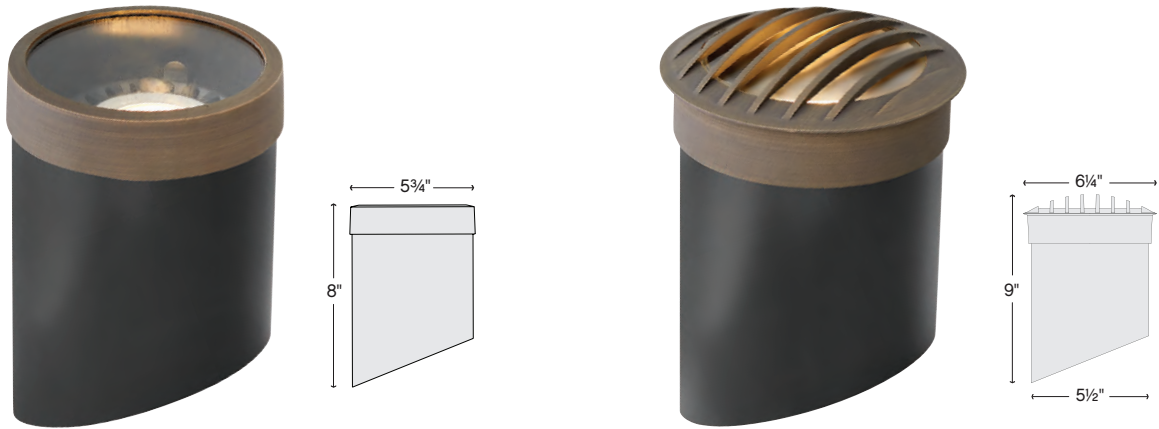

**1598 MZ-FT**  
HARDY ISLAND™  
FLAT TOP PAR36 WELL LIGHT  
5 3/4" DIA., 8" H



**1598 MZ-RG**  
HARDY ISLAND™  
ROCK GUARD PAR36 WELL LIGHT  
6 1/4" DIA., 9" H



ITEM	LED LAMP (NOT INCLUDED)	MAX LED WATTAGE	FINISH	CONSTRUCTION	LENS
1598 BK	PAR36 LED	13w	Black	PVC and Stainless Steel	
1598 MZ-FT	PAR36 LED	13w	Matte Bronze	PVC and Brass	Clear
1598 MZ-RG	PAR36 LED	13w	Matte Bronze	PVC and Brass	Clear

A wiring kit is supplied. For accessories, see page 108. For transformers, see page 104. LED PAR36 sold separately, see page 112 for more details.



**DESIGN  
NOTE**

Calder's perforated metal pattern allows ambient illumination in outdoor gathering spaces such as patios, pergolas and trees. Achieve a statement lighting design by grouping the low voltage Calder pendants in multiples.



**1511 BZ**  
CALDER™  
3½" DIA., 7" H  
 



**1512 BZ**  
CALDER™  
3¼" DIA., 7" H  
 

 LED ITEM	LED LAMP (INCLUDED)	LED WATTAGE / VOLT AMPS	HALOGEN EQUIV.	FINISH	CONSTRUCTION	CANOPY	WIRE/ CHAIN
<b>1511 BZ</b>	00T5-27LED-1.5	1.5w / 1.8VA	25w	Bronze	Cast Aluminum	3½" Dia.	6', 5'
<b>1512 BZ</b>	00T5-27LED-1.5	1.5w / 1.8VA	25w	Bronze	Cast Aluminum	3½" Dia.	6', 5'

A wiring kit is supplied. Photometrics are based off lamp photometrics. See page 115. For accessories, see page 108. For transformers, see page 104. For complete product details and LED specifications, refer to Hinkley.com.

# PATH + AREA LIGHTING



NOUVELLE LANTERN 2778 BLB, HINKLEY.COM  
REX PATH LIGHTS 1534 TK, PAGE 49



HIGH PERFORMANCE  
**BOLLARDS**

---

STREAMLINED DESIGN + DURABILITY + EFFICIENT LIGHT OUTPUT



ATLANTIS 156011T PAGE 38



MINI BOLLARDS  
+ 120V OPTIONS  
AVAILABLE

MINI BOLLARDS PAGE 34  
120V BOLLARDS PAGE 90

**DESIGN  
NOTE**

All large LED bollards feature the LumaCORE system, which has a **LIFETIME WARRANTY**.



**15609 BZ**  
**15609 BZ-LED**  
LUNA™ BOLLARD  
3" DIA., 30" H



**15609 TT**  
**15609 TT-LED**  
LUNA™ BOLLARD  
3" DIA., 30" H



**15607 BK**  
**15607 BK-LED**  
SHELTER™ BOLLARD  
4" W, 30" H, 3" D



ITEM	LED LAMP (NOT INCLUDED)	MAX LED WATTAGE	FINISH	CONSTRUCTION	LENS
<b>15607 BK</b>	MR16	6w	Black	Aluminum	Clear Acrylic Outside Cylinder Seedy Glass Inside Panel
<b>15609 BZ</b>	MR16	6w	Bronze	Aluminum	Etched Glass
<b>15609 TT</b>	MR16	6w	Titanium	Aluminum	Etched Glass

LED ITEM	LED ENGINE (INCLUDED)	LED WATTAGE / VOLT AMPS	COLOR TEMP.	HALOGEN EQUIV.	FINISH	CONSTRUCTION	LENS
<b>15607 BK-LED</b>	27G3SE-35	5w / 5.3VA	2700K	35w	Black	Aluminum	Clear Acrylic Outside Cylinder Seedy Glass Inside Panel
<b>15609 BZ-LED</b>	27G3SE-35	5w / 5.3VA	2700K	35w	Bronze	Aluminum	Etched Glass
<b>15609 TT-LED</b>	27G3SE-35	5w / 5.3VA	2700K	35w	Titanium	Aluminum	Etched Glass

Photometrics for bollards are based off of engine photometrics. See page 110. See pages 112 for lamping options (not included). A wiring kit, 2" diameter, 18" length PVC post and surface mount are supplied. For transformers, see page 104.



**DESIGN  
NOTE**

All large LED bollards feature the LumaCORE system, which has a **LIFETIME WARRANTY**.



**15601 BZ**  
**15601 BZ-LED**  
ATLANTIS™  
ROUND LARGE  
BOLLARD  
3" DIA., 30" H



**15601 TT**  
**15601 TT-LED**  
ATLANTIS™  
ROUND LARGE  
BOLLARD  
3" DIA., 30" H



**15602 BZ**  
**15602 BZ-LED**  
ATLANTIS™  
SQUARE LARGE  
BOLLARD  
3" SQ., 30" H



**15602 TT**  
**15602 TT-LED**  
ATLANTIS™  
SQUARE LARGE  
BOLLARD  
3" SQ., 30" H



LED ITEM	LED LAMP/ ENGINE (INCLUDED)	LED WATTAGE/ VOLT AMPS	COLOR TEMP.	HALOGEN EQUIV.	ITEM	LAMP (NOT INCLUDED)	FINISH	CONSTRUCTION	GLASS
<b>15601 BZ-LED</b>	27G3SE-35	5w / 5.3VA	2700K	35w	<b>15601 BZ</b>	MR16	Bronze	Aluminum	Etched
<b>15601 TT-LED</b>	27G3SE-35	5w / 5.3VA	2700K	35w	<b>15601 TT</b>	MR16	Titanium	Aluminum	Etched
<b>15602 BZ-LED</b>	27G3SE-35	5w / 5.3VA	2700K	35w	<b>15602 BZ</b>	MR16	Bronze	Aluminum	Etched
<b>15602 TT-LED</b>	27G3SE-35	5w / 5.3VA	2700K	35w	<b>15602 TT</b>	MR16	Titanium	Aluminum	Etched

Photometrics for bollards are based off of engine photometrics. See page 110. See page 115 for lamping options (not included). For 15501: A wiring kit and ground spike (0014 BZ, page 109) are supplied. For 15601: A wiring kit, 2" diameter, 18" length PVC post and surface mount are supplied. For accessories, see page 108. For transformers, see page 104.

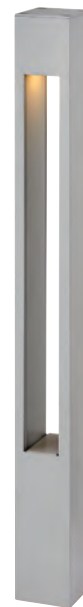

**15501 BZ**  
ATLANTIS™  
ROUND SMALL  
BOLLARD  
2" DIA., 20" H



**15501 TT**  
ATLANTIS™  
ROUND SMALL  
BOLLARD  
2" DIA., 20" H



**15502 BZ**  
ATLANTIS™  
SQUARE SMALL  
BOLLARD  
2" SQ., 20" H



**15502 TT**  
ATLANTIS™  
SQUARE SMALL  
BOLLARD  
2" SQ., 20" H



LED ITEM

	LED LAMP/ ENGINE (INCLUDED)	LED WATTAGE/ VOLT AMPS	COLOR TEMP.	HALOGEN EQUIV.	FINISH	CONSTRUCTION	GLASS
<b>15501 BZ</b>	MR1127K	4w / 4VA	2700K	35w	Bronze	Aluminum	Etched
<b>15501 TT</b>	MR1127K	4w / 4VA	2700K	35w	Titanium	Aluminum	Etched
<b>15502 BZ</b>	MR1127K	4w / 4VA	2700K	35w	Bronze	Aluminum	Etched
<b>15502 TT</b>	MR1127K	4w / 4VA	2700K	35w	Titanium	Aluminum	Etched

Photometrics for bollards are based off of engine photometrics. See page 110. See pages 115 for lamping options (not included). For 15502: A wiring kit and ground spike (0014 BZ, page 109) are supplied. For 15602: A wiring kit, 2" diameter, 18" length PVC post and surface mount are supplied. For accessories, see page 108. For transformers, see page 104.







# SPRINGFIELD PATH LIGHTS

Inspired by Hinkley's superior Hardy Island collection, the complementary new Springfield path light is a robust, practical option in durable cast aluminum with a powder coated finish. Sleek and minimal, Springfield is available in a variety of best-selling sizes and classic finishes to easily accommodate any project.



**16016 BK-LL**  
 SPRINGFIELD MINI  
 CLASSIC PATH LIGHT  
 5¼" DIA., 15¾" H



**16022 BK-LL**  
 SPRINGFIELD SMALL  
 CLASSIC PATH LIGHT  
 8" DIA., 16" H



**16019 BK-LL**  
 SPRINGFIELD LARGE  
 CLASSIC PATH LIGHT  
 8" DIA., 24" H



**16016 OZ-LL**  
 SPRINGFIELD MINI  
 CLASSIC PATH LIGHT  
 5¼" DIA., 15¾" H



**16022 OZ-LL**  
 SPRINGFIELD SMALL  
 CLASSIC PATH LIGHT  
 8" DIA., 16" H



**16019 OZ-LL**  
 SPRINGFIELD LARGE  
 CLASSIC PATH LIGHT  
 8" DIA., 24" H

LED ITEM	LED LAMP (INCLUDED)	LED WATTAGE / VOLT AMPS	COLOR TEMP.	HALOGEN EQUIV.	FINISH	CONSTRUCTION	GLASS
<b>16016 BK-LL</b>	00T3-27LED-1.5	1.5w / 1.8VA	2700K	25w	Black	Aluminum	Clear
<b>16016 OZ-LL</b>	00T3-27LED-1.5	1.5w / 1.8VA	2700K	25w	Oil Rubbed Bronze	Aluminum	Clear
<b>16019 BK-LL</b>	00T3-27LED-1.5	1.5w / 1.8VA	2700K	25w	Black	Aluminum	Clear
<b>16019 OZ-LL</b>	00T3-27LED-1.5	1.5w / 1.8VA	2700K	25w	Oil Rubbed Bronze	Aluminum	Clear
<b>16022 BK-LL</b>	00T3-27LED-1.5	1.5w / 1.8VA	2700K	25w	Black	Aluminum	Clear
<b>16022 OZ-LL</b>	00T3-27LED-1.5	1.5w / 1.8VA	2700K	25w	Oil Rubbed Bronze	Aluminum	Clear

See pages 114 for LED lamps. A wiring kit and ground spike (0014 BZ, page 109) are supplied. For accessories, see page 108. For transformers, see page 104. For complete product details and LED specifications, refer to [Hinkley.com](http://Hinkley.com).

## PHOTOMETRICS

DISTANCE FROM LIGHT	LED ITEM	1'	2'	3'	4'	5'	6'	7'
FOOT CANDLES	16016 BZ-LL, OZ-LL	1.68	0.67	0.29	0.06			
	16019 BZ-LL, OZ-LL	2.85	0.77	0.41	0.23	0.13	0.07	0.01
	16022 BZ-LL, OZ-LL	2.16	0.85	0.33	0.15	0.02		





# FREEPORT PATH LIGHTS

The popular Freeport design is now available as a stylish Coastal Elements path light to coordinate seamlessly with the matching Freeport lantern series in two key finishes. Freeport features a classic New England design constructed from a composite material for timeless, traditional style built to last. The finish is resistant to rust and corrosion with a 5 year warranty.



**15030 OZ-LL**  
 FREEPORT PATH LIGHT  
 6¼" W, 18" H, 7¾" D

**15030 TK-LL**  
 FREEPORT PATH LIGHT  
 6¼" W, 18" H, 7¾" D

 LED ITEM	LED LAMP (INCLUDED)	LED WATTAGE / VOLT AMPS	COLOR TEMP.	HALOGEN EQUIV.	FINISH	CONSTRUCTION	GLASS
<b>15030 OZ-LL</b>	00T5-27LED-1.5	1.5w / 1.8VA	2700K	25w	Oil Rubbed Bronze	Composite	Clear Seedy
<b>15030 TK-LL</b>	00T5-27LED-1.5	1.5w / 1.8VA	2700K	25w	Textured Black	Composite	Clear Seedy

See pages 114 for LED lamps. A wiring kit and ground spike (0014BZ) are supplied. For accessories, see page 108. For transformers, see page 104. For complete product details and LED specifications, refer to Hinkley.com.

### PHOTOMETRICS

DISTANCE FROM LIGHT	LED ITEM	1'	2'	3'	4'	5'	6'	7'
FOOT CANDLES	15030 OZ-LL, TK-LL	3.54	1.30	0.44	0.19	0.07	0.02	0.01



**DESIGN  
NOTE**

Open center provides a unique visual effect



**15540 BK**  
AURA™ LED  
PATH LIGHT  
7" W, 21½" H, 7" D



**15540 BZ**  
AURA™ LED  
PATH LIGHT  
7" W, 21½" H, 7" D



**15714 BZ**  
ARC™ LED  
PATH LIGHT  
17" W, 23" H, 1½" D



LED ITEM	LED ENGINE (INCLUDED)	MAX WATTAGE / VOLT AMPS	LUMENS	COLOR TEMP.	HALOGEN EQUIV.	LIFESPAN	FINISH	CONSTRUCTION	LENS
15540 BK	E2G4W9V - Integrated	1.5w / 3.9VA	225	2700K	25w	40,000 hrs	Black	Aluminum	Acrylic
15540 BZ	E2G4W9V - Integrated	1.5w / 3.9VA	225	2700K	25w	40,000 hrs	Bronze	Aluminum	Acrylic
15714 BZ	E5050LED - Integrated	1.5w / 3.9VA	120	2700K	10w	40,000 hrs	Bronze	Aluminum	Etched Acrylic Lens

A wiring kit and ground spike (0014 BZ, page 109) are supplied. For accessories, see page 108. For transformers, see page 104.

**PHOTOMETRICS**

DISTANCE FROM LIGHT	LED ITEM	1'	2'	3'	4'	5'	6'	7'
FOOT CANDLES	15540 BK, BZ	See Hinkley.com for photometrics						
	15714 BZ	7.02	2.52	1.06	0.35	0.16	0.12	



**1548 SK-LL**  
PIZA™ LED  
PATH LIGHT  
10" W, 15" H, 1¾" D  
10" EXT.  
 

**1548 BZ-LL**  
PIZA™ LED  
PATH LIGHT  
10" W, 15" H, 1¾" D  
10" EXT.  
 

**1548 TT-LL**  
PIZA™ LED  
PATH LIGHT  
10" W, 15" H, 1¾" D  
10" EXT.  
 

 LED ITEM	LED LAMP (INCLUDED)	MAX WATTAGE / VOLT AMPS	COLOR TEMP.	HALOGEN EQUIV.	FINISH	CONSTRUCTION	LENS
<b>1548 BZ-LL</b>	EA-LMW-1.5W	1.5w / 2.5VA	2700K	25w	Bronze	Aluminum	Etched
<b>1548 SK-LL</b>	EA-LMW-1.5W	1.5w / 2.5VA	2700K	25w	Satin Black	Aluminum	Etched
<b>1548 TT-LL</b>	EA-LMW-1.5W	1.5w / 2.5VA	2700K	25w	Titanium	Aluminum	Etched

See pages 114 for LED lamps. A wiring kit and ground spike (0014 BZ, page 109) are supplied. For accessories, see page 108. For transformers, see page 104.

**PHOTOMETRICS**

DISTANCE FROM LIGHT	LED ITEM	1'	2'	3'	4'	5'
FOOT CANDLES	1548 BZ-LL, SK-LL, TT-LL	12.91	2.21	0.81	0.22	0.09



**DESIGN  
NOTE**

Omni-directional lamp included



**1502 CY-LL**  
CONTEMPO™ LED  
PATH LIGHT  
7" W, 22" H, 7¾" D



**1502 BZ-LL**  
CONTEMPO™ LED  
PATH LIGHT  
7" W, 22" H, 7¾" D



**1550 BZ**  
REVOLVE™ LED  
PATH LIGHT  
7¼" W, 22½" H, 6" D



LED ITEM	LED LAMP (INCLUDED)	MAX WATTAGE / VOLT AMPS	COLOR TEMP.	HALOGEN EQUIV.	FINISH	CONSTRUCTION	GLASS
1502 BZ-LL	EA-LMW-1.5W	1.5w / 2.5VA	2700K	25w	Bronze	Aluminum	Etched Opal
1502 CY-LL	EA-LMW-1.5W	1.5w / 2.5VA	2700K	25w	Charcoal Gray	Aluminum	Etched Opal
1550 BZ	00T5-27LED-1.5	1.5w / 1.8VA	2700K	25w	Bronze	Aluminum	Clear Seedy

See pages 114 for LED lamps. A wiring kit and ground spike (0014 BZ, page 109) are supplied. For accessories, see page 108. For transformers, see page 104.

**PHOTOMETRICS**

DISTANCE FROM LIGHT	LED ITEM	1'	2'	3'	4'	5'	6'	7'	8'	9'
FOOT CANDLES	1502 BZ-LL, CY-LL	6.8	2.72	1.18	0.6	0.36	0.23	0.16	0.11	
	1550 BZ	4.33	2.31	0.93	0.42	0.21	0.13	0.08	0.05	0.03



**15102 TK-LL**  
 FOUNDRY™ LED  
 PATH LIGHT  
 7" W, 22" H, 9" D



**15102 MR-LL**  
 FOUNDRY™ LED  
 PATH LIGHT  
 7" W, 22" H, 9" D



**1566 DZ-LL**  
 ATWELL™ LED  
 PATH LIGHT  
 8¾" W, 25½" H, 8" D



**1566 OZ-LL**  
 ATWELL™ LED  
 PATH LIGHT  
 8¾" W, 25½" H, 8" D



LED ITEM	LED LAMP (INCLUDED)	MAX WATTAGE / VOLT AMPS	COLOR TEMP.	HALOGEN EQUIV.	FINISH	CONSTRUCTION	GLASS
15102 TK-LL	00T5-27LED-1.5	1.5w / 1.8VA	2700K	25w	Textured Black	Composite & Aluminum	
15102 MR-LL	00T5-27LED-1.5	1.5w / 1.8VA	2700K	25w	Museum Bronze	Composite & Aluminum	
1566 DZ-LL	00T5-27LED-1.5	1.5w / 1.8VA	2700K	25w	Aged Zinc	Aluminum	Clear Seedy
1566 OZ-LL	00T5-27LED-1.5	1.5w / 1.8VA	2700K	25w	Oil Rubbed Bronze	Aluminum	Clear Seedy

See pages 114 for LED lamps. A wiring kit and ground spike (0014 BZ, page 109) are supplied. For accessories, see page 108. For transformers, see page 104.

**PHOTOMETRICS**

DISTANCE FROM LIGHT	LED ITEM	1'	2'	3'	4'	5'	6'	7'	8'
FOOT CANDLES	15102 TK-LL, MR-LL	See Hinkley.com for photometrics							
	1566 DZ-LL, OZ-LL	2.01	1.95	0.96	0.37	0.18	0.08	0.06	0.02





**DESIGN  
NOTE**

Atlantis 1518 CD-LL is made from natural cedar wood, featuring individually unique wood grain patterns and color tones



**1518 BZ-LL**  
ATLANTIS™ LARGE  
PATH LIGHT  
6½" W, 22" H, 1¼" D



**1518 CD-LL**  
ATLANTIS™ LARGE  
PATH LIGHT  
6½" W, 22" H, 1¼" D



**1518 HE-LL**  
ATLANTIS™ LARGE  
PATH LIGHT  
6½" W, 22" H, 1¼" D



**1518 MZ-LL**  
SOLID BRASS  
ATLANTIS™ LARGE  
PATH LIGHT  
6½" W, 22" H, 1¼" D



**1518 SK-LL**  
ATLANTIS™ LARGE  
PATH LIGHT  
6½" W, 22" H, 1¼" D



**1518 TT-LL**  
ATLANTIS™ LARGE  
PATH LIGHT  
6½" W, 22" H, 1¼" D



LED ITEM	LED LAMP (INCLUDED)	MAX WATTAGE / VOLT AMPS	COLOR TEMP.	INCAN. EQUIV.	FINISH	CONSTRUCTION	LENS
<b>1518 BZ-LL</b>	EA-LMW-1.5W	1.5w / 2.5VA	2700K	25w	Bronze	Aluminum	Etched
<b>1518 CD-LL</b>	EA-LMW-1.5W	1.5w / 2.5VA	2700K	25w	Cedar	Natural Cedar and Aluminum	Etched
<b>1518 HE-LL</b>	EA-LMW-1.5W	1.5w / 2.5VA	2700K	25w	Hematite	Aluminum	Etched
<b>1518 MZ-LL</b>	EA-LMW-1.5W	1.5w / 2.5VA	2700K	25w	Matte Bronze	Solid Brass	Clear
<b>1518SK-LL</b>	EA-LMW-1.5W	1.5w / 2.5VA	2700K	25w	Satin Black	Aluminum	Etched
<b>1518 TT-LL</b>	EA-LMW-1.5W	1.5w / 2.5VA	2700K	25w	Titanium	Aluminum	Etched

See pages 114 for LED lamps. A wiring kit and ground spike (0014 BZ, page 109) are supplied. For accessories, see page 108. For transformers, see page 104.

**PHOTOMETRICS**

DISTANCE FROM LIGHT	LED ITEM	0'	1'	2'	3'	4'	5'	6'
FOOT CANDLES	1518 BZ-LL, CD-LL, HE-LL, MZ-LL SK-LL, TT-LL	15.41	7.50	2.04	0.50	0.15	0.05	0.01



**DESIGN NOTE**

Atlantis 1518 MZ-LL and 15014 MZ-LL feature solid brass construction and come with a lifetime warranty.

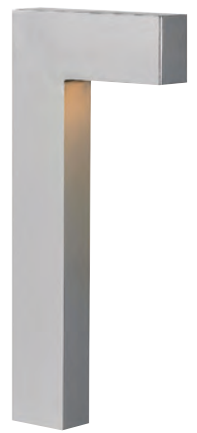

**15014 BZ-LL**  
ATLANTIS™ SMALL  
PATH LIGHT  
6½" W, 15¾" H, 1¾" D



**15014 HE-LL**  
ATLANTIS™ SMALL  
PATH LIGHT  
6½" W, 15¾" H, 1¾" D



**15014 MZ-LL**  
SOLID BRASS  
ATLANTIS™ SMALL  
PATH LIGHT  
6½" W, 15¾" H, 1¾" D



**15014 SK-LL**  
ATLANTIS™ SMALL  
PATH LIGHT  
6½" W, 15¾" H, 1¾" D



**15014 TT-LL**  
ATLANTIS™ SMALL  
PATH LIGHT  
6½" W, 15¾" H, 1¾" D



 LED ITEM	LED LAMP (INCLUDED)	MAX WATTAGE / VOLT AMPS	COLOR TEMP.	INCAN. EQUIV.	FINISH	CONSTRUCTION	LENS
<b>15014 BZ-LL</b>	EA-LMW-1.5W	1.5w / 2.5VA	2700K	25w	Bronze	Aluminum	Etched
<b>15014 HE-LL</b>	EA-LMW-1.5W	1.5w / 2.5VA	2700K	25w	Hematite	Aluminum	Etched
<b>15014 MZ-LL</b>	EA-LMW-1.5W	1.5w / 2.5VA	2700K	25w	Matte Bronze	Solid Brass	Clear
<b>15014 SK-LL</b>	EA-LMW-1.5W	1.5w / 2.5VA	2700K	25w	Satin Black	Aluminum	Etched
<b>15014 TT-LL</b>	EA-LMW-1.5W	1.5w / 2.5VA	2700K	25w	Titanium	Aluminum	Etched

See pages 114 for LED lamps. A wiring kit and ground spike (0014 BZ, page 109) are supplied. For accessories, see page 108. For transformers, see page 104.

**PHOTOMETRICS**

DISTANCE FROM LIGHT	LED ITEM	1'	2'	3'	4'	5'
FOOT CANDLES	15014 BZ-LL, HE-LL, MZ-LL, SK-LL, TT-LL	12.13	1.98	0.36	0.06	0.01





HARDY ISLAND



**16007 MZ-LL**  
HARDY ISLAND™  
LARGE HAMMERED  
PATH LIGHT  
6¾" DIA., 23¼" H



**16010 MZ-LL**  
HARDY ISLAND™  
SMALL HAMMERED  
PATH LIGHT  
6¾" DIA., 15½" H



**16004 MZ-LL**  
HARDY ISLAND™  
SMALL TRADITIONAL  
PATH LIGHT  
7" DIA., 15½" H



**16050 MZ-LL**  
HARDY ISLAND™  
SMALL STANDARD  
PATH LIGHT  
4½" DIA., 15" H



**16055 MZ-LL**  
HARDY ISLAND™  
LARGE STANDARD  
PATH LIGHT  
6½" DIA., 22" H



LED ITEM	LED LAMP (INCLUDED)	MAX WATTAGE / VOLT AMPS	COLOR TEMP.	HALOGEN EQUIV.	FINISH	CONSTRUCTION	GLASS OR LENS
16004 MZ-LL	00T3-27LED-1.5	1.5w / 1.8VA	2700K	25w	Matte Bronze	Cast Brass	Clear Dome
16007 MZ-LL	00T3-27LED-1.5	1.5w / 1.8VA	2700K	25w	Matte Bronze	Cast Brass	Clear Dome
16010 MZ-LL	00T3-27LED-1.5	1.5w / 1.8VA	2700K	25w	Matte Bronze	Cast Brass	Clear Dome
16050 MZ-LL	00T3-27LED-1.5	1.5w / 1.8VA	2700K	25w	Matte Bronze	Cast Brass	Frosted Acrylic
16055 MZ-LL	00T3-27LED-1.5	1.5w / 1.8VA	2700K	25w	Matte Bronze	Cast Brass	Frosted Acrylic

See pages 114 for LED lamps. A wiring kit and ground spike (0014 BZ, page 109) are supplied. For accessories, see page 108. For transformers, see page 104.

PHOTOMETRICS

DISTANCE FROM LIGHT	LED ITEM	1'	2'	3'	4'	5'	6'	7'	8'
FOOT CANDLES	16004 MZ-LL	4.37	1.66	0.67	0.29	0.14	0.08	0.04	0.01
	16007 MZ-LL	3.47	1.29	0.6	0.32	0.18	0.09	0.05	0.02
	16010 MZ-LL	4.51	0.59	0.53	0.26	0.09	0.03	0.01	
	16050 MZ-LL	3.13	0.96	0.24	0.06	0.01			
	16055 MZ-LL	3.06	1.36	0.48	0.27	0.06	0.02		



**16012 MZ-LL**  
HARDY ISLAND™  
ROUND SIDE MOUNT  
PATH LIGHT  
7" W, 18¼" H, 7½" D



**16016 MZ-LL**  
HARDY ISLAND™  
MINI CLASSIC  
PATH LIGHT  
5¼" DIA., 15¾" H



**16022 MZ-LL**  
HARDY ISLAND™  
SMALL CLASSIC  
PATH LIGHT  
8" DIA., 16" H



**16019 MZ-LL**  
HARDY ISLAND™  
LARGE CLASSIC  
PATH LIGHT  
8" DIA., 24" H



LED ITEM	LED LAMP (INCLUDED)	MAX WATTAGE / VOLT AMPS	COLOR TEMP.	HALOGEN EQUIV.	FINISH	CONSTRUCTION	GLASS OR LENS
16012 MZ-LL	EA-LMW-1.5W	1.5w / 2.5VA	2700K	25w	Matte Bronze	Cast Brass	Etched Lens
16016 MZ-LL	00T3-27LED-1.5	1.5w / 1.8VA	2700K	25w	Matte Bronze	Cast Brass	Clear Dome
16019 MZ-LL	00T3-27LED-1.5	1.5w / 1.8VA	2700K	25w	Matte Bronze	Cast Brass	Clear Dome
16022 MZ-LL	00T3-27LED-1.5	1.5w / 1.8VA	2700K	25w	Matte Bronze	Cast Brass	Clear Dome

See pages 114 for LED lamps. A wiring kit and ground spike (0014 BZ, page 109) are supplied. For accessories, see page 108. For transformers, see page 104.

**PHOTOMETRICS**

DISTANCE FROM LIGHT	LED ITEM	1'	2'	3'	4'	5'	6'	7'	8'
FOOT CANDLES	16012 MZ-LL	14.43	6.82	1.78	0.41	0.13	0.04	0.01	
	16016 MZ-LL	1.68	0.67	0.29	0.06				
	16019 MZ-LL	2.85	0.77	0.41	0.23	0.13	0.07	0.01	
	16022 MZ-LL	2.16	2.16	0.33	0.15	0.02			

**DESIGN  
NOTE**



The versatile Rex path light casts a clean white light to illuminate walkways and compliment existing outdoor lighting and décor.





**1531 BZ**  
REX™  
SMALL LED  
PATH LIGHT  
5" DIA., 15" H





**1531 TK**  
REX™  
SMALL LED  
PATH LIGHT  
5" DIA., 15" H





**1533 BZ**  
REX™  
MEDIUM LED  
PATH LIGHT  
5" DIA., 21" H

**1533 TK**  
REX™  
MEDIUM LED  
PATH LIGHT  
5" DIA., 21" H

 LED ITEM	LED LAMP (INCLUDED)	MAX WATTAGE / VOLT AMPS	COLOR TEMP.	HALOGEN EQUIV.	FINISH	CONSTRUCTION	LENS
<b>1531 BZ</b>	00T3-27LED-1.5	1.5w / 1.8VA	2700K	25w	Bronze	Aluminum	Clear
<b>1531 TK</b>	00T3-27LED-1.5	1.5w / 1.8VA	2700K	25w	Textured Black	Aluminum	Clear
<b>1533 BZ</b>	00T3-27LED-1.5	1.5w / 1.8VA	2700K	25w	Bronze	Aluminum	Clear
<b>1533 TK</b>	00T3-27LED-1.5	1.5w / 1.8VA	2700K	25w	Textured Black	Aluminum	Clear

See pages 114 for LED lamps. A wiring kit and ground spike (0014 BZ, page 109) are supplied. For accessories, see page 108. For transformers, see page 104.

**PHOTOMETRICS**

DISTANCE FROM LIGHT	LED ITEM	1'	2'	3'	4'
FOOT CANDLES	1531 BZ, 1531 TK	3.2	0.823	0.034	
	1533 BZ, 1533 TK	2.786	1.31	0.443	0.67







**1534 BZ**  
 REX™  
 LARGE LED  
 PATH LIGHT  
 8" DIA., 30" H





**1534 TK**  
 REX™  
 LARGE LED  
 PATH LIGHT  
 8" DIA., 30" H

 LED ITEM	LED LAMP (INCLUDED)	MAX WATTAGE / VOLT AMPS	COLOR TEMP.	HALOGEN EQUIV.	FINISH	CONSTRUCTION	LENS
<b>1534 BZ</b>	00T3-27LED-1.5	1.5w / 1.8VA	2700K	25w	Bronze	Aluminum	Clear
<b>1534 TK</b>	00T3-27LED-1.5	1.5w / 1.8VA	2700K	25w	Textured Black	Aluminum	Clear

See pages 114 for LED lamps. A wiring kit and ground spike (0014 BZ, page 109) are supplied. For accessories, see page 108. For transformers, see page 104.

**PHOTOMETRICS**

DISTANCE FROM LIGHT	LED ITEM	1'	2'	3'	4'	5'	6'	7'
FOOT CANDLES	1534 BZ, 1534 TK	4.65	1.667	0.695	0.367	0.166	0.05	0.014



**1547 BK-LL**  
SHELTER™ LED  
PATH LIGHT  
4¾" W, 22½" H, 4½" D



**1547 KZ-LL**  
SHELTER™ LED  
PATH LIGHT  
4¾" W, 22½" H, 4½" D



**1579 MT-LL**  
SATURN™ LED  
PATH LIGHT  
4½" DIA., 13¾" H



**1579 SS-LL**  
SATURN™ LED  
PATH LIGHT  
4½" DIA., 13¾" H



LED ITEM	LED LAMP (INCLUDED)	MAX WATTAGE / VOLT AMPS	COLOR TEMP.	HALOGEN EQUIV.	FINISH	CONSTRUCTION	GLASS
1547 BK-LL	00T5-27LED-1.5	1.5w / 1.8VA	2700K	25w	Black	Aluminum	Clear Seedy
1547 KZ-LL	00T5-27LED-1.5	1.5w / 1.8VA	2700K	25w	Buckeye Bronze	Aluminum	Clear Seedy
1579 MT-LL	00T5-27LED-2.5	2.5w / 4.6VA	2700K	25w	Metro Bronze	Solid Brass	Etched Opal
1579 SS-LL	00T5-27LED-2.5	2.5w / 4.6VA	2700K	25w	Stainless Steel	Stainless Steel	Etched Opal

See pages 114 for LED lamps. A wiring kit and ground spike (0014 BZ, page 109) are supplied. For accessories, see page 108. For transformers, see page 104.

**PHOTOMETRICS**

DISTANCE FROM LIGHT	LED ITEM	1'	2'	3'	4'	5'	6'	7'	8'
FOOT CANDLES	1547 BK-LL, KZ-LL	1.49	0.95	0.54	0.15	0.06			
	1579 MT-LL, SS-LL	1.52	0.59	0.24	0.11	0.06	0.04	0.02	0.01



**1504 BZ**  
CARSON™ LED  
PATH LIGHT  
6" W, 22" H, 7" D



**1561 AR-LL**  
HARBOR™ LED  
PATH LIGHT  
7½" W, 21" H, 7" D



**1561 SK-LL**  
HARBOR™ LED  
PATH LIGHT  
7½" W, 21" H, 7" D



**1560 AR-LL**  
HARBOR™ LED  
PATH LIGHT  
7" SQ., 24" H



LED ITEM	LED ENGINE / LAMP (INCLUDED)	MAX WATTAGE / VOLT AMPS	LUMENS	COLOR TEMP.	HALOGEN EQUIV.	LIFESPAN	FINISH	CONSTRUCTION	GLASS
1504 BZ	E5050LED - Integrated	2.3w / 3.9VA	120	2700K	10w	40,000 hrs	Bronze	Aluminum	Etched Lens
1560 AR-LL	00T5-27LED-2.5	2.5w / 4.6VA		2700K	25w		Anchor Bronze	Cast Aluminum	Etched Amber Seedy Bound
1561 AR-LL	EA-LMW-1.5W	1.5w / 2.5VA		2700K	25w		Anchor Bronze	Aluminum	Etched Lens
1561 SK-LL	EA-LMW-1.5W	1.5w / 2.5VA		2700K	25w		Satin Black	Aluminum	Etched Lens

See pages 114 for LED lamps. A wiring kit and ground spike (0014 BZ, page 109) are supplied. For accessories, see page 108. For transformers, see page 104.

**PHOTOMETRICS**

DISTANCE FROM LIGHT	LED ITEM	1'	2'	3'	4'	5'	6'	7'	8'
FOOT CANDLES	1504 BZ	0.85	0.33	0.003					
	1561 AR-LL, SK-LL	10.14	3.18	0.8	0.29	0.1	0.03	0.01	0.01
	1560 AR-LL	0.64	0.53	0.29	0.14	0.07	0.03	0.01	





**1555 CB-LL**  
BRATENAHL™ LED  
PATH LIGHT  
7¼" W, 25" H, 4½" D



**1513 MB-LL**  
RALEY™ LED  
PATH LIGHT  
4½" W, 22" H, 5½" D



**1513 OZ-LL**  
RALEY™ LED  
PATH LIGHT  
4½" W, 22" H, 5½" D



**1529 CB-LL**  
PLANTATION™ LED  
PATH LIGHT  
3½" DIA., 22" H



LED ITEM	LED LAMP (INCLUDED)	MAX WATTAGE / VOLT AMPS	COLOR TEMP.	HALOGEN EQUIV.	FINISH	CONSTRUCTION	GLASS
1513 MB-LL	00T5-27LED-1.5	1.5w / 1.8VA	2700K	25w	Museum Black	Aluminum	Clear Water Glass Panels
1513 OZ-LL	00T5-27LED-1.5	1.5w / 1.8VA	2700K	25w	Oil Rubbed Bronze	Aluminum	Clear Water Glass Panels
1529 CB-LL	00T5-27LED-1.5	1.5w / 1.8VA	2700K	25w	Copper Bronze	Aluminum	Clear Optic
1555 CB-LL	00T5-27LED-1.5	1.5w / 1.8VA	2700K	25w	Copper Bronze	Solid Brass	Clear Seedy

See pages 114 for LED lamps. A wiring kit and ground spike (0014 BZ, page 109) are supplied. For accessories, see page 108. For transformers, see page 104.

**PHOTOMETRICS**

DISTANCE FROM LIGHT	LED ITEM	1'	2'	3'	4'	5'	6'	7'	8'	9'
FOOT CANDLES	1555 CB-LL	0.72	0.92	0.43	0.25	0.12	0.1	0.06	0.01	
	1513 MB-LL, OZ-LL	2.06	1.13	0.53	0.26	0.12	0.06	0.03	0.02	0.01
	1529 CB-LL	0.50	1.25	0.25	0.32	0.12	0.11	0.06	0.05	0.05



**1403 OC-LL**  
ESSENCE™ LED  
PATH LIGHT  
6" DIA., 17" H



**1552 SZ-LL**  
PALM™ LED  
PATH LIGHT  
6¾" DIA., 22" H



**1540 CB-LL**  
MONTICELLO™ LED  
PATH LIGHT  
8" W, 12¾" H, 7" D



**1567 RY-LL**  
MIRABELLA™ LED  
PATH LIGHT  
8" DIA., 22" H



LED ITEM	LED LAMP (INCLUDED)	MAX WATTAGE / VOLT AMPS	COLOR TEMP.	HALOGEN EQUIV.	FINISH	CONSTRUCTION	GLASS
<b>1403 OC-LL</b>	00T5-27LED-1.5	1.5w / 1.8VA	2700K	25w	Old Copper	Copper	Frosted Shield
<b>1540 CB-LL</b>	00T5-27LED-1.5	1.5w / 1.8VA	2700K	25w	Copper Bronze	Solid Brass	
<b>1552 SZ-LL</b>	00T5-27LED-1.5	1.5w / 1.8VA	2700K	25w	Sienna Bronze	Solid Brass	
<b>1567 RY-LL</b>	00T5-27LED-1.5	1.5w / 1.8VA	2700K	25w	Royal Bronze	Solid Brass	Honey Art

See pages 114 for LED lamps. A wiring kit and ground spike (0014 BZ, page 109) are supplied. For accessories, see page 108. For transformers, see page 104.

**PHOTOMETRICS**

DISTANCE FROM LIGHT	LED ITEM	1'	2'	3'	4'	5'	6'
FOOT CANDLES	1403 OC-LL	3.41	1.10	0.37	0.15	0.05	0.01
	1552 SZ-LL	2.25	1.15	0.53	0.29	0.10	0.05
	1540 CB-LL	3.41	1.27	0.46	0.11	0.01	
	1567 RY-LL	2.11	0.90	0.35	0.14	0.05	0.02



**1516 MR-LL**  
LEDGEWOOD™ LED  
PATH LIGHT  
5" W, 15" H, 3½" D



**1508 CB-LL**  
IVY™ LED  
PATH LIGHT  
8¼" W, 26" H, 6" D



**1554 SZ-LL**  
ASPEN™ LED  
PATH LIGHT  
7" W, 22" H, 5" D



**1568 RB-LL**  
SQUIRREL™ LED  
PATH LIGHT  
6½" W, 22" H, 4½" D

LED ITEM	LED LAMP (INCLUDED)	MAX WATTAGE / VOLT AMPS	COLOR TEMP.	HALOGEN EQUIV.	FINISH	CONSTRUCTION	GLASS
1508 CB-LL	00T5-27LED-2.5	2.5w / 4.6VA	2700K	25w	Copper Bronze	Solid Brass	Light Amber
1516 MR-LL	00T5-27LED-2.5	2.5w / 4.6VA	2700K	25w	Museum Bronze	Aluminum	Champagne Inside Etched
1554 SZ-LL	00T5-27LED-2.5	2.5w / 4.6VA	2700K	25w	Sienna Bronze	Solid Brass	Honey Art
1568 RB-LL	00T5-27LED-2.5	2.5w / 4.6VA	2700K	25w	Regency Bronze	Aluminum	Champagne Marble

See pages 114 for LED lamps. A wiring kit and ground spike (0014 BZ, page 109) are supplied. For accessories, see page 108. For transformers, see page 104.

**PHOTOMETRICS**

DISTANCE FROM LIGHT	LED ITEM	1'	2'	3'	4'	5'	6'	7'	8'	9'	10'	11'
FOOT CANDLES	1508 CB-LL	4.39	2.57	1.15	0.58	0.30	0.15	0.09	0.06	0.04	0.02	0.01
	1516 MR-LL	1.87	1.42	0.66	0.34	0.19	0.12	0.08	0.05	0.03		
	1554 SZ-LL	5.57	0.36	0.10	0.03							
	1568 RB-LL	5.18	1.97	0.78	0.36	0.20	0.12	0.07	0.05	0.01		



# DECK/STEP/PATIO LIGHTING



NUVI HARDSCAPE LIGHTS 15446 BZ, PAGE 59  
PORTER LANTERN 2805 DZ, HINKLEY.COM



# NUVI™

## COLLECTION

---

Hinkley's durable, long lasting Nuvi Material is vinyl alloy tested to withstand harsh environments and backed by an industry leading lifetime warranty.



### THE NUVI™ COLLECTION FEATURES + BENEFITS:

- Lifetime warranty
- Dimmable
- 12V LED
- Tested to withstand harsh environments
- Rated for indoor/outdoor use
- Ease of installation
- Mounts flush on a surface
- Excellent forward and downward light distribution
- ADA compliant



**DESIGN NOTE**

Nuvi's small footprint and slim profile provide exceptional illumination for the smallest of spaces in decks, steps, and patio lighting

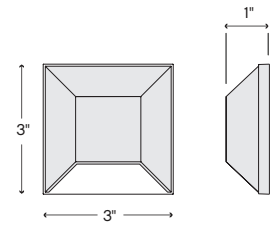

**15222 BK**  
NUVI™ SQUARE DECK SCONCE  
3" W, 3" H, 1" EXT.



**15222 BZ**  
NUVI™ SQUARE DECK SCONCE  
3" W, 3" H, 1" EXT.



**15222 MW**  
NUVI™ SQUARE DECK SCONCE  
3" W, 3" H, 1" EXT.

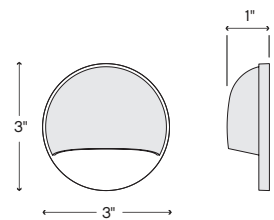
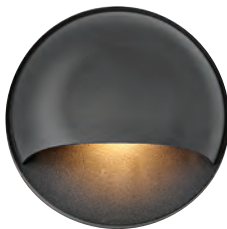

**15232 BK**  
NUVI™ ROUND DECK SCONCE  
3" W, 3" H, 1" EXT.



**15232 BZ**  
NUVI™ ROUND DECK SCONCE  
3" W, 3" H, 1" EXT.



**15232 MW**  
NUVI™ ROUND DECK SCONCE  
3" W, 3" H, 1" EXT.



LED ITEM	LED ENGINE (INCLUDED)	MAX WATTAGE / VOLT AMPS	LUMENS	COLOR TEMP.	HALOGEN EQUIV.	LIFESPAN	FINISH	CONSTRUCTION
15222 BK	NX1	1.2w / 1.5VA	100	2700K	20w	40,000 hrs	Black	Vinyl Alloy
15222 BZ	NX1	1.2w / 1.5VA	100	2700K	20w	40,000 hrs	Bronze	Vinyl Alloy
15222 MW	NX1	1.2w / 1.5VA	100	2700K	20w	40,000 hrs	Matte White	Vinyl Alloy
15232 BK	NX1	1.2w / 1.5VA	100	2700K	20w	40,000 hrs	Black	Vinyl Alloy
15232 BZ	NX1	1.2w / 1.5VA	100	2700K	20w	40,000 hrs	Bronze	Vinyl Alloy
15232 MW	NX1	1.2w / 1.5VA	100	2700K	20w	40,000 hrs	Matte White	Vinyl Alloy

A wiring kit is supplied. For accessories, see page 108. For transformers, see page 104.



# NUVI™ HARDSCAPE

Available in 3 sizes + 3 colors  
 Exceptional 12V LED horizontal  
 illumination due to innovative  
 composite optic technology  
 Suitable for harsh environments

2 1/8" bracket depth easily  
 cuts to 1 1/2" OR 3/4"  
 Dimmable  
 Lifetime warranty

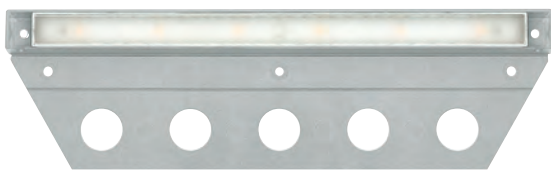

**15448 TT**  
 NUVI™ LARGE  
 DECK SCONCE  
 10" W, 3/4" H, 3" Dv  
 2 1/8" BRACKET DEPTH



**15448 BZ**  
 NUVI™ LARGE  
 DECK SCONCE  
 10" W, 3/4" H, 3" D  
 2 1/8" BRACKET DEPTH

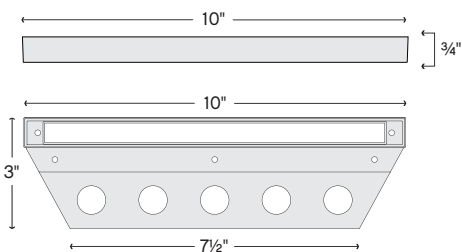

**15448 ST**  
 NUVI™ LARGE  
 DECK SCONCE  
 10" W, 3/4" H, 3" D  
 2 1/8" BRACKET DEPTH

LED ITEM	LED ENGINE (INCLUDED)	MAX WATTAGE / VOLT AMPS	LUMENS	COLOR TEMP.	HALOGEN EQUIV.	LIFESPAN	FINISH	CONSTRUCTION	LENS
15448 BZ	NX5	3.5w / 6VA	260	2700K	25w	40,000 hrs	Bronze	Vinyl Alloy	Composite PC
15448 ST	NX5	3.5w / 6VA	260	2700K	25w	40,000 hrs	Sandstone	Vinyl Alloy	Composite PC
15448 TT	NX5	3.5w / 6VA	260	2700K	25w	40,000 hrs	Titanium	Vinyl Alloy	Composite PC

For full warranty information, visit [Hinkley.com](http://Hinkley.com). For accessories, see page 108. For transformers, see page 104.

**PHOTOMETRICS** (BASED ON VARIOUS MOUNTING HEIGHTS)

DISTANCE FROM LIGHT		LED ITEM	1'	2'	3'	4'
FOOT CANDLES	12" Mounting	15448 BZ	28.3	6.94	3.01	1.65
	24" Mounting	15448 ST	14.1	6.08	3.05	1.71
	36" Mounting	15448 TT	7.56	4.46	2.73	1.79

**NUVI™ HARDSCAPE SPACING RECOMMENDATIONS**

MOUNTING HEIGHT	LED ITEM	CENTER TO CENTER
12"	15448 BZ	30"
24"	15448 ST	36"
36"	15448 TT	42"



**15446 ST**  
**15446 ST-10**  
 NUVI™ MEDIUM  
 DECK SCONCE  
 5" W, 3/4" H, 3" D  
 2 1/8" BRACKET DEPTH



**15446 TT**  
**15446 TT-10**  
 NUVI™ MEDIUM  
 DECK SCONCE  
 5" W, 3/4" H, 3" D  
 2 1/8" BRACKET DEPTH



**15446 BZ**  
**15446 BZ-10**  
 NUVI™ MEDIUM  
 DECK SCONCE  
 5" W, 3/4" H, 3" D  
 2 1/8" BRACKET DEPTH

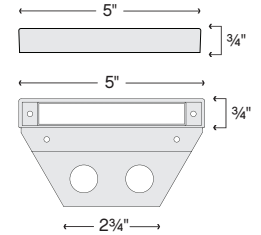

**15444 BZ**  
**15444 BZ-10**  
 NUVI™ SMALL  
 DECK SCONCE  
 3/4" W, 3/4" H, 3" D  
 2 1/8" BRACKET DEPTH



**15444 TT**  
**15444 TT-10**  
 NUVI™ SMALL  
 DECK SCONCE  
 3/4" W, 3/4" H, 3" D  
 2 1/8" BRACKET DEPTH



**15444 ST**  
**15444 ST-10**  
 NUVI™ SMALL  
 DECK SCONCE  
 3/4" W, 3/4" H, 3" D  
 2 1/8" BRACKET DEPTH

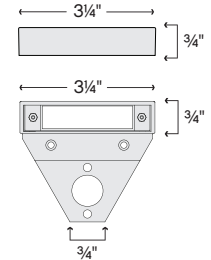

LED ITEM	LED ENGINE (INCLUDED)	MAX WATTAGE / VOLT AMPS	LUMENS	COLOR TEMP.	HALOGEN EQUIV.	LIFESPAN	FINISH	CONSTRUCTION	LENS
15444 BZ, 15444 BZ-10*	NX2	1.1w / 1.5VA	60	2700K	7w	40,000 hrs	Bronze	Vinyl Alloy	Composite PC
15444 ST, 15444 ST-10*	NX2	1.1w / 1.5VA	60	2700K	7w	40,000 hrs	Sandstone	Vinyl Alloy	Composite PC
15444 TT, 15444 TT-10*	NX2	1.1w / 1.5VA	60	2700K	7w	40,000 hrs	Titanium	Vinyl Alloy	Composite PC
15446 BZ, 15446 BZ-10*	NX4	1.9w / 2.8VA	140	2700K	20w	40,000 hrs	Bronze	Vinyl Alloy	Composite PC
15446 ST, 15446 ST-10*	NX4	1.9w / 2.8VA	140	2700K	20w	40,000 hrs	Sandstone	Vinyl Alloy	Composite PC
15446 TT, 15446 TT-10*	NX4	1.9w / 2.8VA	140	2700K	20w	40,000 hrs	Titanium	Vinyl Alloy	Composite PC

For full warranty information, visit [Hinkley.com](http://Hinkley.com). For accessories, see page 108. For transformers, see page 104. \*Available as packages of 10.

**PHOTOMETRICS (BASED ON VARIOUS MOUNTING HEIGHTS)**

DISTANCE FROM LIGHT		LED ITEM	1'	2'	3'	4'
FOOT CANDLES	12" Mounting	15444 BZ	8.14	1.89	0.77	0.41
	24" Mounting	15444 ST	5.81	4.10	1.74	0.87
	36" Mounting	15444 TT	2.22	1.30	0.75	0.46
	12" Mounting	15446 BZ	20.42	10.33	5.35	2.91
	24" Mounting	15446 ST	4.80	4.45	3.61	2.02
	36" Mounting	15446 TT	2.15	2.24	2.03	1.31

**HARDSCAPE SPACING RECOMMENDATIONS**

MOUNTING HEIGHT	LED ITEM	CENTER TO CENTER
12"	15444 BZ	24"
24"	15444 ST	24"
36"	15444 TT	30"
12"	15446 BZ	24"
24"	15446 ST	30"
36"	15446 TT	36"







# BRAVO™ HARDSCAPE

Linear head rotates 150° for precise adjustments

Provided with a modifiable mounting plate

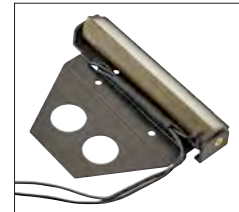
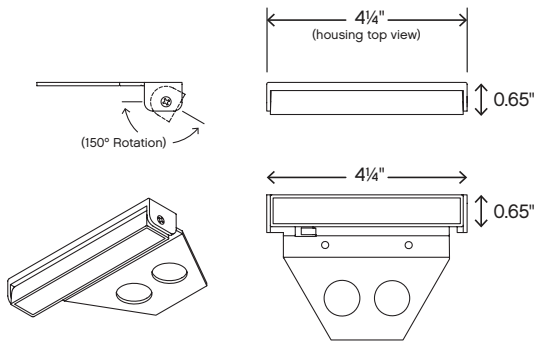

Shown in tilted installation configuration.



Shown in regular installation configuration.



Service wire loop included

## DESIGN NOTES

Linear head rotates 150° for precise adjustments. Design incorporates a service wire loop.

**15556 MZ**  
HARDY ISLAND™  
BRAVO LED  
HARDSCAPE  
4 1/4" W, 3/4" H, 3" D



LED ITEM	LED ENGINE (INCLUDED)	MAX WATTAGE / VOLT AMPS	LUMENS	COLOR TEMP.	HALOGEN EQUIV.	LIFESPAN	FINISH	CONSTRUCTION	LENS
15556 MZ	NX4	1.9w / 2.8VA	140	2700K	20w	40,000 hrs	Matte Bronze	Cast Brass & Composite	Composite PC

A wiring kit is supplied. For transformers, see page 104.

### PHOTOMETRICS (BASED ON VARIOUS MOUNTING HEIGHTS)

DISTANCE FROM LIGHT		LED ITEM	1'	2'	3'	4'
FOOT CANDLES	12" Mounting	15556 MZ	20.42	10.33	5.35	2.91
	24" Mounting		4.80	4.45	3.61	2.02
	36" Mounting		2.15	2.24	2.03	1.31

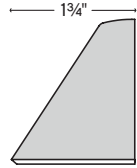
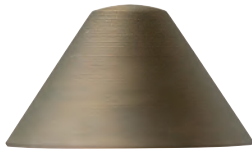

**16805 MZ-LED**  
HARDY ISLAND™ TRIANGULAR  
DECK SCONCE  
3 1/2" DIA., 2" H, 1 3/4" EXT.

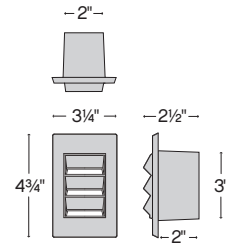

**1542 BZ**  
**1542 BZ-LED**  
VERTICAL DECK LIGHT  
3 1/4" W, 4 3/4" H, 2 3/4" D,

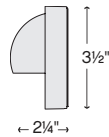

**16801 MZ-LL**  
HARDY ISLAND™ ROUND  
EYEBROW DECK SCONCE  
3 1/2" DIA., 2" EXT.

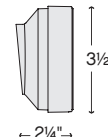

**16804 MZ-LL**  
HARDY ISLAND™ ROUND  
LOUVERED DECK SCONCE  
3 1/2" DIA., 2" EXT.



LED ITEM	LED ENGINE / LAMP (INCLUDED)	MAX WATTAGE/ VOLT AMPS	COLOR TEMP.	HALOGEN EQUIV.	ITEM	LAMP (INCLUDED)	WATTAGE	LED LAMP (NOT INCLUDED)	FINISH	CONSTRUCTION	LENS
<b>1542 BZ-LED</b>	E5050LED	1.5w / 3.9VA	2700K	10w	<b>1542 BZ</b>	0912	12w	T5 LED	Bronze	Cast Aluminum	Frosted
<b>16801 MZ-LL</b>	00T3-27LED	1.5w / 1.8VA	2700K	25w					Matte Bronze	Cast Brass	Frosted
<b>16804 MZ-LL</b>	00T3-27LED	1.5w / 1.8VA	2700K	25w					Matte Bronze	Cast Brass	Frosted
<b>16805 MZ-LED</b>	E5050LED	1.5w / 3.9VA	2700K	10w					Matte Bronze	Cast Brass	Frosted

See page 114 for LED conversion lamps. A wiring kit is supplied. For accessories, see page 108. For transformers, see page 104.

**PHOTOMETRICS** (BASED ON VARIOUS MOUNTING HEIGHTS)

DISTANCE FROM LIGHT		LED ITEM	1'	2'	3'	4'	5'	6'	7'	ITEM	1'	2'	3'	4'	5'	6'	7'	
FOOT CANDLES	6" Mounting	1542 BZ-LED	1.77	0.37	0.12	0.07	0.04			1542 BZ	1.44	0.30	0.10	0.03	0.06			
	18" Mounting		1.02	0.47	0.23	0.11	0.07				0.83	0.38	0.19	0.09	0.06	0.03		
	30" Mounting		0.43	0.34	0.22	0.15	0.09	0.06	0.04		0.35	0.28	0.18	0.12	0.07	0.05	0.03	
	6" Mounting	16801 MZ-LL	1.63	0.22	0.03													
	18" Mounting		0.23	0.36	0.14	0.03	0.01											
	30" Mounting		0.07	0.19	0.13	0.07	0.04	0.01										
	6" Mounting	16804 MZ-LL	1.87	0.16	0.01													
	18" Mounting		1.08	0.54	0.15	0.02	0.01											
	30" Mounting		0.02	0.23	0.21	0.1	0.04	0.01										
	6" Mounting	16805 MZ-LED	4.40	2.48	0.68	0.10												
	18" Mounting		10.84	5.10	1.64	0.22	0.13	0.04										
	30" Mounting		4.83	3.42	1.93	0.81	0.25	0.12	0.09									



**1546 BZ-LL**  
HORIZONTAL LED DECK LIGHT  
4¾" W, 3¼" H, 2½" D



**1546 MZ-LL**  
HARDY ISLAND™  
HORIZONTAL LED DECK LIGHT  
4¾" W, 3¼" H, 2½" D

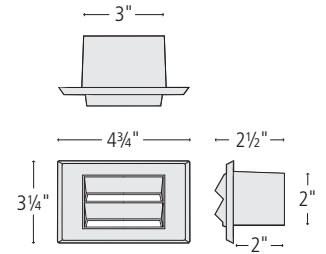

**1594 BZ-LL**  
LOUVERED BRICK LIGHT  
8¾" W, 3¼" H, 3¾" D

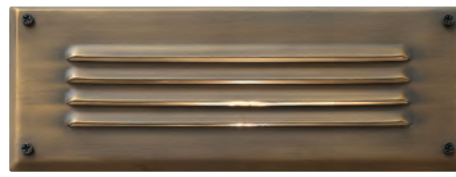

**1594 MZ-LL**  
HARDY ISLAND™  
LOUVERED BRICK LIGHT  
8¾" W, 3¼" H, 3¾" D

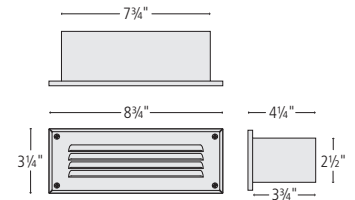

LED ITEM	LED LAMP (INCLUDED)	MAX WATTAGE / VOLT AMPS	COLOR TEMP.	HALOGEN EQUIV.	FINISH	CONSTRUCTION	LENS
1546 BZ-LL	EA-LMW-1.5W	1.5w / 2.5VA	2700K	25w	Bronze	Cast Aluminum	Frosted
1546 MZ-LL	EA-LMW-1.5W	1.5w / 2.5VA	2700K	25w	Matte Bronze	Cast Brass Faceplate	Frosted
1594 BZ-LL	EA-LMW-1.5W	1.5w / 2.5VA	2700K	25w	Bronze	Cast Aluminum Faceplate	Clear
1594 MZ-LL	EA-LMW-1.5W	1.5w / 2.5VA	2700K	25w	Matte Bronze	Solid Brass Faceplate	Clear

See page 114 for LED conversion lamps. A wiring kit is supplied. For accessories, see page 108. For transformers, see page 104.

**PHOTOMETRICS** (BASED ON VARIOUS MOUNTING HEIGHTS)

DISTANCE FROM LIGHT		LED ITEM	1'	2'	3'	4'	5'	6'	7'	8'	9'	10'
FOOT CANDLES	6" Mounting	1546 BZ-LL	2.9	0.2	0.09	0.01						
	18" Mounting		0.77	0.67	0.15	0.05	0.01					
	30" Mounting		0.14	0.44	0.37	0.14	0.04	0.01				
	6" Mounting	1546 MZ-LL	0.46	0.02	0.01							
	18" Mounting		0.76	0.28	0.02	0.01						
	30" Mounting		0.29	0.28	0.09	0.01						
	6" Mounting	1594 BZ-LL	1.02	0.02	0.01	0.04	0.01					
	18" Mounting		0.56	0.29	0.43	0.12	0.01					
	30" Mounting		0.23	0.3	0.16	0.02	0.07					
	6" Mounting	1594 MZ-LL	2.33	0.78	0.45	0.15	0.02	0.01				
	18" Mounting		0.15	0.45	0.14	0.28	0.29	0.09	0.04	0.01		
	30" Mounting		0.03	0.08	0.28	0.09	0.06	0.14	0.15	0.05	0.03	0.01



# 12V TAPER™ LIGHTS

Dimmable  
Rated for indoor/outdoor use

Ease of installation  
Excellent forward and downward light distribution

Seamlessly blending into architectural elements inside or outside the home, Taper beautifully illuminates stairs, walkways, or patio spaces to enhance the outdoor lighting experience.



**1553 BZ**  
12V TAPER™ DECK SCONCE  
4½" W, 3" H, 1" EXT.



**1553 SW**  
12V TAPER™ DECK SCONCE  
4½" W, 3" H, 1" EXT.



1553 SW  
(SIDE VIEW)

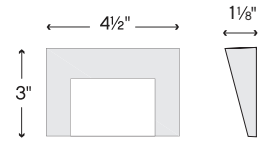

**1557 BZ**  
12V TAPER™ DECK SCONCE  
8" W, 3" H, 1" EXT.



**1557 SW**  
12V TAPER™ DECK SCONCE  
8" W, 3" H, 1" EXT.

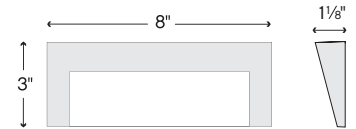

LED ITEM	LED ENGINE (INTEGRATED)	MAX WATTAGE / VOLT AMPS	LUMENS	COLOR TEMP.	HALOGEN EQUIV.	LIFESPAN	FINISH	CONSTRUCTION	LENS
1553 BZ	TP15	1.9w / 2.3VA	160	2700K	15w	40,000 hrs	Bronze	Cast Aluminum	Etched
1553 SW	TP15	1.9w / 2.3VA	160	2700K	15w	40,000 hrs	Satin White	Cast Aluminum	Etched
1557 BZ	TP25	2.5w / 3VA	300	2700K	25w	40,000 hrs	Bronze	Cast Aluminum	Etched
1557 SW	TP25	2.5w / 3VA	300	2700K	25w	40,000 hrs	Satin White	Cast Aluminum	Etched

A wiring kit is supplied. For coordinating Taper lanterns, see Hinkley.com. For accessories, see page 108. For transformers, see page 104.

**PHOTOMETRICS** (BASED ON VARIOUS MOUNTING HEIGHTS)

DISTANCE FROM LIGHT		LED ITEM	1'	2'	3'	4'	5'	6'	7'	8'	9'	10'
FOOT CANDLES	12" Mounting	1553 BZ	8.3	1.294	0.358	0.136	0.039	0.007				
	18" Mounting		10.64	1.989	0.555	0.218	0.076	0.029	0.004			
	12" Mounting	1553 SW	18.63	3.261	0.787	0.342	0.127	0.084	0.037	0.01		
	18" Mounting		12.6	3.62	1.461	0.644	0.309	0.189	0.103	0.067	0.032	0.003
	12" Mounting	1557 BZ	12.23	1.138	0.204	0.045						
	18" Mounting		10.46	2.113	0.655	0.212	0.064	0.026	0.011			
	12" Mounting	1557 SW	26.13	4.221	1.019	0.44	0.23	0.123	0.079	0.03	0.015	0.004
	18" Mounting		25.39	6.48	2.22	0.737	0.383	0.224	0.108	0.095	0.051	0.001

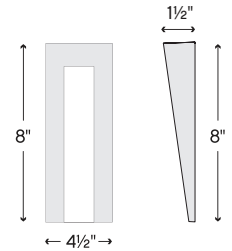
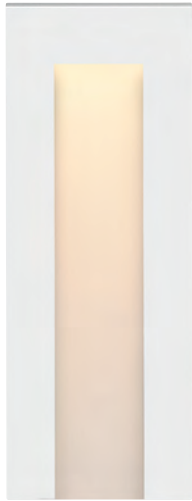

**1551 SW**

12V TAPER™ DECK SCONCE  
3" W, 8" H, 1 1/2" EXT.



**1551 BZ**

12V TAPER™ DECK SCONCE  
3" W, 8" H, 1 1/2" EXT.



1551 SW  
(SIDE VIEW)

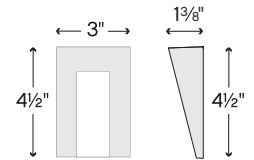

**1556 SW**

12V TAPER™ DECK SCONCE  
3" W, 4 1/2" H, 1 3/8" EXT.



**1556 BZ**

12V TAPER™ DECK SCONCE  
3" W, 4 1/2" H, 1 3/8" EXT.



1556 BZ  
(SIDE VIEW)

LED ITEM	LED ENGINE (INTEGRATED)	MAX WATTAGE / VOLT AMPS	LUMENS	COLOR TEMP.	HALOGEN EQUIV.	LIFESPAN	FINISH	CONSTRUCTION	LENS
1551 SW	TP10	1.2w / 1.5VA	90	2700K	10w	40,000 hrs	Satin White	Cast Aluminum	Etched
1551 BZ	TP10	1.2w / 1.5VA	90	2700K	10w	40,000 hrs	Bronze	Cast Aluminum	Etched
1556 SW	TP10	1.2w / 1.5VA	90	2700K	10w	40,000 hrs	Satin White	Cast Aluminum	Etched
1556 BZ	TP10	1.2w / 1.5VA	90	2700K	10w	40,000 hrs	Bronze	Cast Aluminum	Etched

A wiring kit is supplied. For coordinating Taper lanterns, see Hinkley.com. For accessories, see page 108. For transformers, see page 104.

**PHOTOMETRICS (BASED ON VARIOUS MOUNTING HEIGHTS)**

DISTANCE FROM LIGHT		LED ITEM	1'	2'	3'	4'	5'	6'	7'	8'	9'	10'
FOOT CANDLES	18" Mounting	1551 SW	10.13	3.334	1.228	0.49	0.23	0.112	0.07	0.035	0.024	0.002
	36" Mounting		3.35	2.104	1.205	0.665	0.383	0.245	0.165	0.117	0.075	0.045
	12" Mounting	1556 SW	15.83	2.39	0.73	0.28	0.114	0.053	0.019			
	18" Mounting		7.67	2.79	0.838	0.415	0.199	0.106	0.054	0.001		
	18" Mounting	1551 BZ	10.13	3.334	1.228	0.49	0.23	0.112	0.07	0.035	0.024	0.002
	36" Mounting		3.35	2.104	1.205	0.665	0.383	0.245	0.165	0.117	0.075	0.045
	12" Mounting	1556 BZ	7.86	0.941	0.18	0.055	0.003					
	18" Mounting		5.12	1.291	0.332	0.117	0.05	0.008				

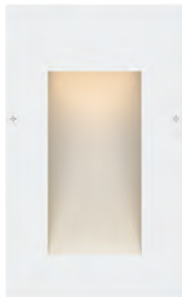

**1562 SW**  
12V TAPER™ STEP LIGHT  
3" W, 5" H, 1½" D

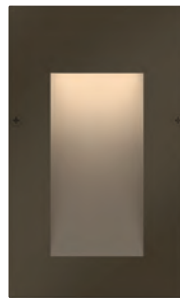

**1562 BZ**  
12V TAPER™ STEP LIGHT  
3" W, 5" H, 1½" D

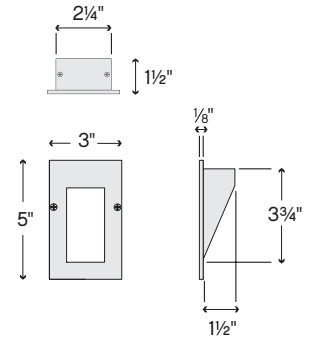

**1563 SW**  
12V TAPER™ STEP LIGHT  
4½" W, 3¼" H, 1" D

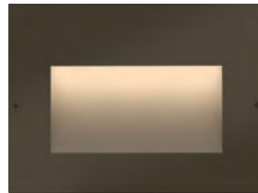

**1563 BZ**  
12V TAPER™ STEP LIGHT  
4½" W, 3¼" H, 1" D

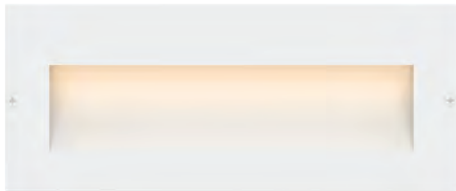
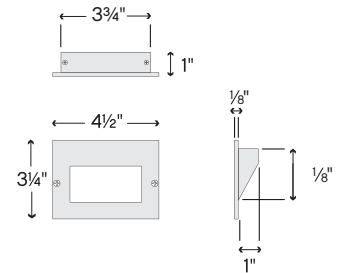

**1565 SW**  
12V TAPER™ STEP LIGHT  
8" W, 3¼" H, 1" D



**1565 BZ**  
12V TAPER™ STEP LIGHT  
8" W, 3¼" H, 1" D

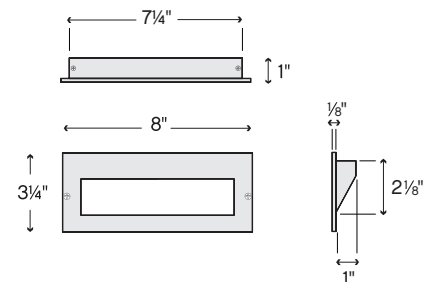

LED ITEM	LED ENGINE (INTEGRATED)	LED WATTAGE / VOLT AMPS	LUMENS	COLOR TEMP.	HALOGEN EQUIV.	LIFESPAN	FINISH	CONSTRUCTION	LENS
1562 BZ	TP10	1.2w / 1.5VA	90	2700K	10w	40,000 hrs	Bronze	Cast Aluminum	Etched
1562 SW	TP10	1.2w / 1.5VA	90	2700K	10w	40,000 hrs	Satin White	Cast Aluminum	Etched
1563 BZ	TP15	1.9w / 2.3VA	160	2700K	15w	40,000 hrs	Bronze	Cast Aluminum	Etched
1563 SW	TP15	1.9w / 2.3VA	160	2700K	15w	40,000 hrs	Satin White	Cast Aluminum	Etched
1565 BZ	TP25	2.5w / 3VA	300	2700K	25w	40,000 hrs	Bronze	Cast Aluminum	Etched
1565 SW	TP25	2.5w / 3VA	300	2700K	25w	40,000 hrs	Satin White	Cast Aluminum	Etched

A wiring kit is supplied. For coordinating Taper lanterns, see Hinkley.com. For accessories, see page 108. For transformers, see page 104.







# 12V LUNA

## STEP LIGHT

The Luna step light is the perfect addition to any interior or exterior lighting plan. Luna seamlessly blends into the home and illuminates stairs, walkways or patio spaces. Now available in Satin Black and select 120V models in 3000K.



LUNA STEP 58504 BZ

### 12V LUNA STEP LIGHT FEATURES + BENEFITS:

Dimmable

Fits standard gang junction box

3.8w power consumption

Die cast zinc aluminum alloy

Rated for indoor/outdoor use

Accepts all decorator style  
switch plate covers

120V Available in 2700K or 3000K

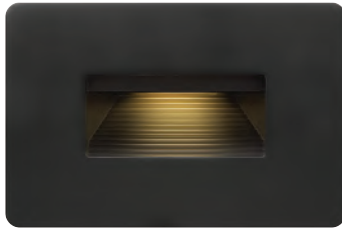

**15508 SK**  
LUNA™ STEP LIGHT  
4½" W, 3" H, 1½" D



**15508 SW**  
12V LUNA™ STEP LIGHT  
4½" W, 3" H, 1½" D



**15508 MZ**  
12V LUNA™ STEP LIGHT  
4½" W, 3" H, 1½" D

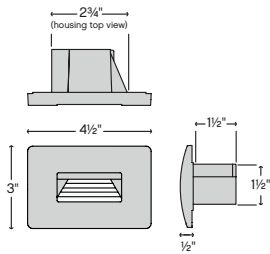

**15508 BZ**  
12V LUNA™ STEP LIGHT  
4½" W, 3" H, 1½" D



**15508 TT**  
12V LUNA™ STEP LIGHT  
4½" W, 3" H, 1½" D



LED ITEM	LED ENGINE (INTEGRATED)	MAX WATTAGE/ VOLT AMPS	LUMENS	COLOR TEMP.	HALOGEN EQUIV.	LIFESPAN	FINISH	CONSTRUCTION
15508 BK	LS-4	3.8w / 6.5VA	200	2700K	20w	40,000 hrs	Satin Black	Zinc Aluminum Alloy
15508 BZ	LS-4	3.8w / 6.5VA	200	2700K	20w	40,000 hrs	Bronze	Zinc Aluminum Alloy
15508 MZ	LS-4	3.8w / 6.5VA	200	2700K	20w	40,000 hrs	Matte Bronze	Forged Brass Face Plate
15508 SW	LS-4	3.8w / 6.5VA	200	2700K	20w	40,000 hrs	Satin White	Zinc Aluminum Alloy
15508 TT	LS-4	3.8w / 6.5VA	200	2700K	20w	40,000 hrs	Titanium	Zinc Aluminum Alloy

A wiring kit is supplied. For accessories, see page 108. For transformers, see page 104.

**PHOTOMETRICS** (BASED ON VARIOUS MOUNTING HEIGHTS)

DISTANCE FROM LIGHT		LED ITEM	1'	2'	3'	4'	5'	6'	7'	8'	
FOOT CANDLES	8" Mounting	15508 BK	3.58	0.71	0.2						
	16" Mounting			0.86	0.38	0.15					
	30" Mounting				0.27	0.24	0.13				
	8" Mounting	15508 BZ	3.58	0.71	0.2						
	16" Mounting			0.86	0.38	0.15					
	30" Mounting				0.27	0.24	0.13				
	8" Mounting	15508 MZ	3.58	0.71	0.20						
	16" Mounting			0.86	0.38	0.15					
	30" Mounting				0.27	0.24	0.13				
	8" Mounting	15508 SW	7	2.19	0.97	0.57	0.37	0.26	0.19	0.14	
	16" Mounting			0.66	0.158	0.85	0.5	0.32	0.23	0.16	0.12
	30" Mounting				0.32	0.52	0.43	0.3	0.23	0.16	0.12
8" Mounting	15508 TT	4.5	1.8	0.45	0.25	0.15	0.11				
16" Mounting				1.03	0.54	0.27	0.15	0.1			
30" Mounting					0.32	0.29	0.19	0.12			



CHIC DESIGNS RATED FOR USE IN BOTH INTERIOR AND EXTERIOR SPACES



ALDER PENDANT 11154 BK  
WEYMOUTH WALL MOUNT 20015 BK  
HINKLEY.COM

## OPEN AIR™ collection

Outdoor living spaces blend the best of both worlds with interior-inspired décor and the invigorating element of nature. Hinkley's collection of outdoor-rated chandeliers are appropriate for any exterior space—a dining terrace, backyard pergola or front porch—that will extend your hours of entertainment and enjoyment long after dark.

**CHOOSE FROM 11 CHIC DESIGNS TO ILLUMINATE YOUR ALFRESCO ENVIRONMENT**



# LOW VOLTAGE LUXURY LIGHTING



LAKEHOUSE CHANDELIER 2689 DZ-LV, PAGE 81  
LAKEHOUSE WALL MOUNT 2680 DZ, HINKLEY.COM

# LOW VOLTAGE LUXURY

## LIGHTING

Hinkley's groundbreaking low voltage decorative lighting designs deliver high style exterior spaces with ease. Part of the Total Outdoor Solutions offering, this curated assortment of striking Hinkley outdoor fixtures includes stylish pier and post mount lanterns and stunning Open Air chandeliers and pendants, customized with 12-volt vintage filament lamps. Simply pair with a Hinkley low-voltage transformer and voila! A complete decorative lighting solution for every outdoor space.



REID 29505 BGR-LV, PAGE 82

### LOW VOLTAGE LUXURY LIGHTING FEATURES + BENEFITS:

Innovative exterior 12-volt solution for all-in-one lamp, lighting and high design look

Variety of stylish fixtures customized with vintage filament lamps

Offers semi-permanent solutions for unique areas such as pergolas when paired with low voltage Hinkley transformer

12-volt LED vintage filament lamps included

12-volt vintage filament lamps also available

Transformer required, see options on page 106





**2561 MB-LV**  
ALFORD PLACE POST MOUNT  
10" W, 20¼" H  
12V LED



**2561 OZ-LV**  
ALFORD PLACE POST MOUNT  
10" W, 20¼" H  
12V LED



**1161 AH-LV**  
ATWATER POST MOUNT  
9½" W, 23" H  
12V LED, Dimmable, LED



**1161 BK-LV**  
ATWATER POST MOUNT  
9½" W, 23" H  
12V LED, Dimmable, LED



**2361 MB-LV**  
BROMLEY POST MOUNT  
10" W, 22¾" H  
12V LED



**2361 OZ-LV**  
BROMLEY POST MOUNT  
10" W, 22¾" H  
12V LED



**1671 BK-LV**  
EDGEWATER POST MOUNT  
10" DIA., 21¼" H  
12V LED



**1677 BK-LV**  
EDGEWATER POST MOUNT  
15" DIA., 27¾" H  
12V LED

12V LED ITEM	LED LAMP (INCLUDED)	MAX WATTAGE / VOLT AMPS	COLOR TEMP.	HALOGEN EQUIV.	FINISH	CONSTRUCTION	GLASS
2561 MB-LV	E12LED12V	2-3.5w Cand. / 9.2VA	2700K	2-35w	Museum Black	Aluminum	Clear
2561 OZ-LV	E12LED12V	2-3.5w Cand. / 9.2VA	2700K	2-35w	Oil Rubbed Bronze	Aluminum	Clear
1161 AH-LV	E26LED12V	1-3.5w Med. / 4.6VA	2700K	1-35w	Ash Bronze	Composite	Clear Seedy
1161 BK-LV	E26LED12V	1-3.5w Med. / 4.6VA	2700K	1-35w	Black	Composite	Clear Seedy
2361 MB-LV	E12LED12V	3-3.5w Cand. / 12.9VA	2700K	3-35w	Museum Black	Aluminum	Clear
2361 OZ-LV	E12LED12V	3-3.5w Cand. / 12.9VA	2700K	3-35w	Oil Rubbed Bronze	Aluminum	Clear
1671 BK-LV	E12LED12V	3-3.5w Cand. / 12.9VA	2700K	3-35w	Black	Aluminum	Clear Seedy
1677 BK-LV	E12LED12V	4-3.5w Cand. / 16.7VA	2700K	4-35w	Black	Aluminum	Clear Seedy

Images are for reference purpose only and may not be pictured with the specified LED filament lamp. For more information on lamp specifications, see page 116. For complete product details and LED specifications see Hinkley.com.



**1861 OZ-LV**  
FREEPORT POST MOUNT  
8" DIA., 20½" H



**1861 TK-LV**  
FREEPORT POST MOUNT  
8" DIA., 20½" H



**2687 DZ-LV**  
LAKEHOUSE POST MOUNT  
9" DIA., 18¾" H



**2687 BK-LV**  
LAKEHOUSE POST MOUNT  
9" DIA., 18¾" H



**2221 CB-LV**  
PLANTATION POST MOUNT  
10¼" DIA., 25¼" H



**2121 MB-LV**  
PLANTATION POST MOUNT  
10¼" DIA., 25¼" H



**2227 CB-LV**  
PLANTATION POST MOUNT  
12½" DIA., 29½" H



<b>12V</b> LED ITEM	LED LAMP (INCLUDED)	MAX WATTAGE / VOLT AMPS	COLOR TEMP.	HALOGEN EQUIV.	FINISH	CONSTRUCTION	GLASS
<b>1861 OZ-LV</b>	E26LED12V	1-3.5w Med. / 4.6VA	2700K	1-35w	Oil Rubbed Bronze	Composite	Clear Seedy
<b>1861 TK-LV</b>	E26LED12V	1-3.5w Med. / 4.6VA	2700K	1-35w	Textured Black	Composite	Clear Seedy
<b>2687 DZ-LV</b>	E26LED12V	1-3.5w Med. / 4.6VA	2700K	1-35w	Aged Zinc	Aluminum	Clear Seedy
<b>2687 BK-LV</b>	E26LED12V	1-3.5w Med. / 4.6VA	2700K	1-35w	Black	Aluminum	Clear Seedy
<b>2221 CB-LV</b>	E12LED12V	3-3.5w Cand. / 12.9VA	2700K	3-35w	Copper Bronze	Solid Brass	Clear Optic
<b>2121 MB-LV</b>	E12LED12V	3-3.5w Cand. / 12.9VA	2700K	3-35w	Museum Black	Aluminum	Clear Optic
<b>2227 CB-LV</b>	E12LED12V	4-3.5w Cand. / 16.7VA	2700K	4-35w	Copper Bronze	Solid Brass	Clear Optic

Images are for reference purpose only and may not be pictured with the specified LED filament lamp. For more information on lamp specifications, see page 116. For complete product details and LED specifications see Hinkley.com.



**2801 DZ-LV**  
PORTER POST MOUNT  
6½" W, 22¾" H



**2801 OZ-LV**  
PORTER POST MOUNT  
6½" W, 22¾" H



**1601 MB-LV**  
RALEY POST MOUNT  
11¾" DIA., 26¼" H



**1601 OZ-LV**  
RALEY POST MOUNT  
11¾" DIA., 26¼" H



**1001 BK-LV**  
REPUBLIC POST MOUNT  
7" W, 17" H



**1001 OZ-LV**  
REPUBLIC POST MOUNT  
7" W, 17" H



**1001 SI-LV**  
REPUBLIC POST MOUNT  
7" W, 17" H



LED ITEM	LED LAMP (INCLUDED)	MAX WATTAGE / VOLT AMPS	COLOR TEMP.	HALOGEN EQUIV.	FINISH	CONSTRUCTION	GLASS
<b>2801 DZ-LV</b>	E26LED12V	1-3.5w Med. / 4.6VA	2700K	1-35w	Aged Zinc	Aluminum	Clear
<b>2801 OZ-LV</b>	E26LED12V	1-3.5w Med. / 4.6VA	2700K	1-35w	Oil Rubbed Bronze	Aluminum	Clear
<b>1601 MB-LV</b>	E12LED12V	4-3.5w Cand. / 16.7VA	2700K	4-35w	Museum Black	Aluminum	Clear Water Glass Panels
<b>1601 OZ-LV</b>	E12LED12V	4-3.5w Cand. / 16.7VA	2700K	4-35w	Oil Rubbed Bronze	Aluminum	Clear Seedy Glass Panels
<b>1001 BK-LV</b>	E26LED12V	1-3.5w Med. / 4.6VA	2700K	1-35w	Black	Composite	Clear Seedy
<b>1001 OZ-LV</b>	E26LED12V	1-3.5w Med. / 4.6VA	2700K	1-35w	Oil Rubbed Bronze	Composite	Clear Seedy
<b>1001 SI-LV</b>	E26LED12V	1-3.5w Med. / 4.6VA	2700K	1-35w	Satin Nickel	Composite	Clear Seedy

Images are for reference purpose only and may not be pictured with the specified LED filament lamp. For more information on lamp specifications, see page 116. For complete product details and LED specifications see Hinkley.com.





**1901 MT-LV**  
SATURN POST MOUNT  
10" DIA., 21¾" H  
12V



**1901 SS-LV**  
SATURN POST MOUNT  
10" DIA., 21¾" H  
12V



**1321 BK-LV**  
SHELTER POST MOUNT  
8¼" W, 27¾" H  
12V



**1321 KZ-LV**  
SHELTER POST MOUNT  
8¼" W, 27¾" H  
12V



**1857 DZ-LV**  
ANCHORAGE PIER MOUNT  
11" W, 23½" H  
12V



**1857 LZ-LV**  
ANCHORAGE PIER MOUNT  
11" W, 23½" H  
12V



**1167 AH-LV**  
ATWATER PIER MOUNT  
9½" W, 21½" H  
12V



**1167 BK-LV**  
ATWATER PIER MOUNT  
9½" W, 21½" H  
12V

LED ITEM	LED LAMP (INCLUDED)	MAX WATTAGE / VOLT AMPS	COLOR TEMP.	HALOGEN EQUIV.	FINISH	CONSTRUCTION	GLASS
<b>1901 MT-LV</b>	E26LED12V	1-3.5w Med. / 4.6VA	2700K	1-35w	Metro Bronze	Solid Brass	Etched Opal
<b>1901 SS-LV</b>	E26LED12V	1-3.5w Med. / 4.6VA	2700K	1-35w	Stainless Steel	Stainless Steel	Etched Opal
<b>1321 BK-LV</b>	E26LED12V	1-3.5w Med. / 4.6VA	2700K	1-35w	Black	Aluminum	Clear Seedy
<b>1321 KZ-LV</b>	E26LED12V	1-3.5w Med. / 4.6VA	2700K	1-35w	Buckeye Bronze	Aluminum	Clear Seedy
<b>1857 DZ-LV</b>	E12LED12V	3-3.5w Cand. / 12.9VA	2700K	3-35w	Aged Zinc	Aluminum	Clear
<b>1857 LZ-LV</b>	E12LED12V	3-3.5w Cand. / 12.9VA	2700K	3-35w	Light Oiled Bronze	Aluminum	Clear
<b>1167 AH-LV</b>	E26LED12V	1-3.5w Med. / 4.6VA	2700K	1-35w	Ash Bronze	Composite	Clear Seedy
<b>1167 BK-LV</b>	E26LED12V	1-3.5w Med. / 4.6VA	2700K	1-35w	Black	Composite	Clear Seedy

Images are for reference purpose only and may not be pictured with the specified LED filament lamp. For more information on lamp specifications, see page 116. For complete product details and LED specifications see Hinkley.com. For post and pier mount accessories, see Hinkley.com.



**2047 GS-LV**  
BINGHAM PIER MOUNT  
9¾" W, 21¼" H  
12V



**2047 SN-LV**  
BINGHAM PIER MOUNT  
9¾" W, 21¼" H  
12V



**2576 AR-LV**  
HARBOR PIER MOUNT  
11" W, 17" H  
12V



**2576 SK-LV**  
HARBOR PIER MOUNT  
11" W, 17" H  
12V



**2327 OZ-LV**  
MANHATTAN PIER MOUNT  
11¼" W, 18¼" H  
12V



**1007 BK-LV**  
REPUBLIC PIER MOUNT  
7" W, 16½" H  
12V



**1007 OZ-LV**  
REPUBLIC PIER MOUNT  
7" W, 16½" H  
12V



**1007 SI-LV**  
REPUBLIC PIER MOUNT  
7" W, 16½" H  
12V

12V LED ITEM	LED LAMP (INCLUDED)	MAX WATTAGE / VOLT AMPS	COLOR TEMP.	HALOGEN EQUIV.	FINISH	CONSTRUCTION	GLASS
2047 GS-LV	E12LED12V	3-3.5w Cand. / 12.9VA	2700K	3-35w	Greystone	Aluminum	Clear Seedy
2047 SN-LV	E12LED12V	3-3.5w Cand. / 12.9VA	2700K	3-35w	Sienna	Solid Brass	Clear Seedy
2576 AR-LV	E26LED12V	1-3.5w Med. / 4.6VA	2700K	1-35w	Anchor Bronze	Aluminum	Etched Amber Seedy Bound
2576 SK-LV	E26LED12V	1-3.5w Med. / 4.6VA	2700K	1-35w	Satin Black	Aluminum	Etched Seedy Bound
2327 OZ-LV	E26LED12V	1-3.5w Med. / 4.6VA	2700K	1-35w	Oil Rubbed Bronze	Aluminum	Clear Beveled
1007 BK-LV	E26LED12V	1-3.5w Med. / 4.6VA	2700K	1-35w	Black	Composite	Clear Seedy
1007 OZ-LV	E26LED12V	1-3.5w Med. / 4.6VA	2700K	1-35w	Oil Rubbed Bronze	Composite	Clear Seedy
1007 SI-LV	E26LED12V	1-3.5w Med. / 4.6VA	2700K	1-35w	Satin Nickel	Composite	Clear Seedy

Images are for reference purpose only and may not be pictured with the specified LED filament lamp. For more information on lamp specifications, see page 116. For complete product details and LED specifications see Hinkley.com.

PIER MOUNTS



**1187 BLB-LV**  
REVERE PIER MOUNT  
9¾" W, 20¼" H



**1187 SN-LV**  
REVERE PIER MOUNT  
9¾" W, 20¼" H



**2917 DZ-LV**  
SUTCLIFFE PIER MOUNT  
10¼" W, 18" H



**2917 OZ-LV**  
SUTCLIFFE PIER MOUNT  
10¼" W, 18" H



**1437 DZ-LV**  
TRELLIS PIER MOUNT  
11" W, 19¾" H



**1437 RB-LV**  
TRELLIS PIER MOUNT  
11" W, 19¾" H



**20017 BK-LV**  
WEYMOUTH PIER MOUNT  
9" W, 20¼" H



<b>12V</b> LED ITEM	LED LAMP (INCLUDED)	MAX WATTAGE / VOLT AMPS	COLOR TEMP.	HALOGEN EQUIV.	FINISH	CONSTRUCTION	GLASS
<b>1187 BLB-LV</b>	E12LED12V	3-3.5w Cand. / 12.9VA	2700K	3-35w	Blackened Brass	Solid Brass	Clear Seedy
<b>1187 SN-LV</b>	E12LED12V	3-3.5w Cand. / 12.9VA	2700K	3-35w	Sienna	Solid Brass	Clear Seedy
<b>2917 DZ-LV</b>	E12LED12V	3-3.5w Cand. / 12.9VA	2700K	3-35w	Aged Zinc	Aluminum	Clear
<b>2917 OZ-LV</b>	E12LED12V	3-3.5w Cand. / 12.9VA	2700K	3-35w	Oil Rubbed Bronze	Aluminum	Clear
<b>1437 DZ-LV</b>	E12LED12V	4-3.5w Cand. / 16.7VA	2700K	4-35w	Aged Zinc	Aluminum	Clear
<b>1437 RB-LV</b>	E12LED12V	4-3.5w Cand. / 16.7VA	2700K	4-35w	Regency Bronze	Aluminum	Clear Seedy
<b>20017 BK-LV</b>	E12LED12V	3-3.5w Cand. / 12.9VA	2700K	3-35w	Black	Aluminum	Clear Beveled

Images are for reference purpose only and may not be pictured with the specified LED filament lamp. For more information on lamp specifications, see page 116. For complete product details and LED specifications see Hinkley.com.





**1304 HE**  
PIER MOUNT BASE  
Required for Pier Mount Lights



**1304 BZ**  
PIER MOUNT BASE  
Required for Pier Mount Lights



**1304 BK**  
PIER MOUNT BASE  
Required for Pier Mount Lights

For our full offering of posts and pier mounts, visit [Hinkley.com](http://Hinkley.com).

DIRECT BURIAL POSTS

(bury 18" below ground level)



6808 BK



6638 BK



6660 OI, 6660 TK,  
6660 TR, 6662 TK

ITEM	DIAMETER	HEIGHT	FITTER DIAMETER	WALL THICKNESS	CONSTRUCTION	ACCESSORIES INCLUDED/NOTES
1304BK	7"	3½"			Cast Aluminum	
1304BZ	7"	3½"			Aluminum	
1304HE	7"	3½"			Aluminum	
6638 BK	3"	6½'	3"	.080"	Post, Cast Aluminum	Cast Aluminum Base
6660 TK, OR, OI	3"	7'	3"	.050"	One-Piece Post, Aluminum	
6662 TK	3"	7'	3"	.050"	One-Piece Post, Aluminum	Photo Cell
6808 BK	10½"	8'	3"	.125"	Post, Cast Aluminum	Decorative Flange Bolt Cover

LV MEDIUM BASE	E26LED12V	
	WATTAGE	3.5w
	VOLT AMPS	4.6VA
	LUMENS	360
	COLOR TEMP.	2700K
	CRI	80
	HALOGEN EQUIV.	1 x 35W
	LIFESPAN	15,000 hrs
	BASE	E26
	DIMMABLE	Yes - MLV On Transformer Primary

LV CANDELABRA BASE	E12LED12V	
	WATTAGE	3.5w
	VOLT AMPS	4.7VA
	LUMENS	360
	COLOR TEMP.	2700K
	CRI	80
	HALOGEN EQUIV.	1 x 35W
	LIFESPAN	15,000 hrs
	BASE	E12
	DIMMABLE	Yes - MLV On Transformer Primary

**DESIGN  
NOTE**

Low Voltage Luxury chandeliers and pendants are rated for indoor/outdoor use.



**2567 MB-LV**  
ALFORD PLACE MEDIUM SINGLE TIER  
17" W, 24½" H



**2567 OZ-LV**  
ALFORD PLACE MEDIUM SINGLE TIER  
17" W, 24½" H



**2569 MB-LV**  
ALFORD PLACE SIX LIGHT LINEAR  
40" W, 18¾" H, 12" D



**2569 OZ-LV**  
ALFORD PLACE SIX LIGHT LINEAR  
40" W, 18¾" H, 12" D



<b>12V</b> LED ITEM	LED LAMP (INCLUDED)	MAX WATTAGE / VOLT AMPS	COLOR TEMP.	HALOGEN EQUIV.	FINISH	CONSTRUCTION	GLASS
<b>2567 MB-LV</b>	E12LED12V	4-3.5w Cand. / 16.7VA	2700K	4-35w	Museum Black	Aluminum	Clear Seedy
<b>2567 OZ-LV</b>	E12LED12V	4-3.5w Cand. / 16.7VA	2700K	4-35w	Oil Rubbed Bronze	Aluminum	Clear Seedy
<b>2569 MB-LV</b>	E12LED12V	6-3.5w Cand. / 24.3VA	2700K	6-35w	Museum Black	Aluminum	Clear Seedy
<b>2569 OZ-LV</b>	E12LED12V	6-3.5w Cand. / 24.3VA	2700K	6-35w	Oil Rubbed Bronze	Aluminum	Clear Seedy

Images are for reference purpose only and may not be pictured with the specified LED filament lamp. For more information on lamp specifications, see page 116. For complete product details and LED specifications see Hinkley.com.

**DESIGN  
NOTE**

Low Voltage Luxury chandeliers and pendants are rated for indoor/outdoor use.



**29705 VI-LV**  
CARSON LARGE ORB  
26½" DIA., 26¼" H



**29703 VI-LV**  
CARSON MEDIUM ORB  
18½" DIA., 18¾" H



**2689 DZ-LV**  
LAKEHOUSE MEDIUM SINGLE TIER  
42" DIA., 32" H



**2689 BK-LV**  
LAKEHOUSE MEDIUM SINGLE TIER  
42" DIA., 32" H



LED ITEM	LED LAMP (INCLUDED)	MAX WATTAGE / VOLT AMPS	COLOR TEMP.	HALOGEN EQUIV.	FINISH	CONSTRUCTION	GLASS
<b>29705 VI-LV</b>	E12LED12V	5-3.5w Cand. / 20.6VA	2700K	5-35w	Vintage Iron	Aluminum	Clear Seedy
<b>29703 VI-LV</b>	E12LED12V	3-3.5w Cand. / 12.9VA	2700K	3-35w	Vintage Iron	Aluminum	Clear Seedy
<b>2689 DZ-LV</b>	E26LED12V	6-3.5w Med. / 24.3VA	2700K	6-35w	Aged Zinc	Aluminum	Clear Seedy
<b>2689 BK-LV</b>	E26LED12V	6-3.5w Med. / 24.3VA	2700K	6-35w	Black	Aluminum	Clear Seedy

Images are for reference purpose only and may not be pictured with the specified LED filament lamp. For more information on lamp specifications, see page 116. For complete product details and LED specifications see Hinkley.com.



**DESIGN  
NOTE**

Low Voltage Luxury chandeliers and pendants are rated for indoor/outdoor use.



**29504 BGR-LV**  
REID MEDIUM SINGLE TIER  
20" DIA., 21" H  
12V 1 1



**29505 BGR-LV**  
REID LARGE SINGLE TIER  
28 1/4" DIA., 23" H  
12V 1 1



**29304 BGR-LV**  
RHODES MEDIUM SINGLE TIER  
18 1/4" W, 28 1/4" H  
12V 1 1



**29304 WB-LV**  
RHODES MEDIUM SINGLE TIER  
18 1/4" W, 28 1/4" H  
12V 1 1

12V LED ITEM	LED LAMP (INCLUDED)	MAX WATTAGE / VOLT AMPS	COLOR TEMP.	HALOGEN EQUIV.	FINISH	CONSTRUCTION	GLASS
29504 BGR-LV	E12LED12V	4-3.5w Cand. / 16.7VA	2700K	4-35w	Brushed Graphite	Metal	Clear Seedy
29505 BGR-LV	E12LED12V	6-3.5w Cand. / 24.3VA	2700K	6-35w	Brushed Graphite	Metal	Clear Seedy
29304 BGR-LV	E12LED12V	4-3.5w Cand. / 16.7VA	2700K	4-35w	Brushed Graphite	Metal	Etched Opal
29304 WB-LV	E12LED12V	4-3.5w Cand. / 16.7VA	2700K	4-35w	Warm Bronze	Metal	Clear Seedy

Images are for reference purpose only and may not be pictured with the specified LED filament lamp. For more information on lamp specifications, see page 116. For complete product details and LED specifications see Hinkley.com.





**DESIGN**  
**NOTE**

Low Voltage Luxury chandeliers and pendants are rated for indoor/outdoor use.



**29206 DZ-LV**  
SAWYER MEDIUM SINGLE TIER  
24" DIA., 23¼" H



**29206 SQ-LV**  
SAWYER MEDIUM SINGLE TIER  
24" DIA., 23¼" H



**29208 DZ-LV**  
SAWYER LARGE SINGLE TIER  
30" DIA., 27¾" H



**29208 SQ-LV**  
SAWYER LARGE SINGLE TIER  
30" DIA., 27¾" H



<b>12V</b> LED ITEM	LED LAMP (INCLUDED)	MAX WATTAGE / VOLT AMPS	COLOR TEMP.	HALOGEN EQUIV.	FINISH	CONSTRUCTION	GLASS
<b>29206 DZ-LV</b>	E12LED12V	6-3.5w Cand. / 24.3VA	2700K	6-35w	Aged Zinc	Metal	Clear Seedy
<b>29206 SQ-LV</b>	E12LED12V	6-3.5w Cand. / 24.3VA	2700K	6-35w	Sequoia	Metal	Clear Seedy
<b>29208 DZ-LV</b>	E12LED12V	9-3.5w Cand. / 34.7VA	2700K	9-35w	Aged Zinc	Metal	Clear Seedy
<b>29208 SQ-LV</b>	E12LED12V	9-3.5w Cand. / 34.7VA	2700K	9-35w	Sequoia	Metal	Clear Seedy

Images are for reference purpose only and may not be pictured with the specified LED filament lamp. For more information on lamp specifications, see page 116. For complete product details and LED specifications see Hinkley.com.



# 120V LANDSCAPE LIGHTING





HINKLEY'S LINE VOLTAGE PRODUCTS OFFER THE LIGHTING PROFESSIONAL  
A MORE POWERFUL LANDSCAPE LIGHTING OPTION

# 120 VOLT

---

Line voltage systems operate with more power than their low voltage counterparts and can accommodate larger lamps with much higher wattage, creating significant light output from a small number of fixtures. Line voltage is most commonly used in commercial, security and public use applications. It can also be used in residential applications where extensive up-lighting on large architectural features and mature landscape is required or where a 120v wiring system is already in place.

## LINE VOLTAGE INSTALLATION

A licensed electrical contractor is required to install Line Voltage landscape lighting systems. When installing 120v systems, the wire must be properly buried at least 18 inches in the ground, placed in a protective conduit and have sealed junction boxes at the connection points. Installation is labor intensive and rigid, which makes line voltage systems a more permanent option than low voltage systems. Installation by a professional will ensure the Line Voltage system functions properly. Local code requirements should be consulted. Requires power post for in-ground installation (50500PP).

## QUALITY AND DURABILITY

Hinkley's Line Voltage products are built to last. Constructed of durable aluminum or thermoplastic composite resin, our lighting fixtures stand up to tough weather conditions. Our powder coated finish on all Line Voltage products protects the fixtures from chipping, fading and cracking, which significantly improves the durability and lifespan of our fixtures in even the harshest atmospheric conditions.

## VALUE AND CONVENIENCE

Choosing to install a Line Voltage system can be an economical solution in residential situations where a wiring system is already in place. Rather than re-wire a low voltage system, which requires a transformer and a fresh wiring plan, Hinkley Line Voltage fixtures can be put into place with relative ease. A wide variety of lamping options offers convenience when choosing a Line Voltage system. Traditional incandescent lamps can be used and technology advancements have even led to popularity with self-ballasted fluorescent lamps.



**56000 BK**  
120V MUSHROOM™  
PATH LIGHT  
9½" DIA., 26" H



**56000 BZ**  
120V MUSHROOM™  
PATH LIGHT  
9½" DIA., 26" H



**56000 CY**  
120V MUSHROOM™  
PATH LIGHT  
9½" DIA., 26" H



<b>ITEM</b>	<b>56000</b>
FINISH	Black (BK), Bronze (BZ), Charcoal Gray (CY)
CONSTRUCTION	Durable Cast Aluminum
LENS	Clear Polycarbonate
LAMP (NOT INCLUDED)	A19 (up to 75w)
LED LAMP (NOT INCLUDED)	A19 LED (up to 11w)
WIRING	6" usable 105°C 18-AWG wire leads
SOCKET	E26

For line voltage accessories, see page 102.

**PHOTOMETRICS**

DISTANCE FROM LIGHT	ITEM	1'	2'	3'	4'	5'	6'
FOOT CANDLES	56000	41.67	12.50	4.60	1.39	0.37	0.13



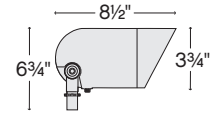

**54000 BK**

120V SM. SPOT LIGHT  
3 3/4" DIA. SHROUD, 6 3/4" H  
8 1/2" W SHROUD

120V

**54000 BZ**

120V SM. SPOT LIGHT  
3 3/4" DIA. SHROUD, 6 3/4" H  
8 1/2" W SHROUD

120V

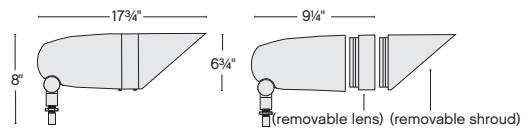

**55000 BZ**

120V LG. SPOT LIGHT  
(Shown with lens)  
6 3/4" DIA. SHROUD, 8" H  
9 1/4" W WITHOUT SHROUD

120V

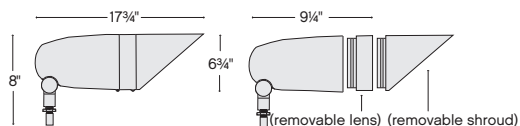

**55000 BZ**  
 120V LG. SPOT LIGHT  
 (Shown with lens and shroud)  
 6 3/4" DIA. SHROUD, 8" H  
 17 3/4" W WITH SHROUD







ITEM	54000	55000 BZ
NAME	Small Spot Light	Large Spot Light (Removable Lens and Shroud)
FINISH	Black (BK), Bronze (BZ)	Bronze (BZ)
CONSTRUCTION	Durable Cast Aluminum	Durable Cast Aluminum
LENS	Clear, Convex, Tempered	Clear, Convex, Tempered
VOLTAGE	120v	120v
LAMP (NOT INCLUDED)	PAR16 or PAR20 (up to 75w)	PAR38 (up to 175w)
LED LAMP (NOT INCLUDED)	PAR 16 LED or PAR20 LED (up to 11w)	PAR 38 LED (up to 18w)
WIRING/WIRING COMPARTMENT	6" usable 200°C 18-AWG wire leads and ground leads	6" usable 200°C 18-AWG wire leads and ground leads
REFLECTOR		
SHROUD	Durable cast aluminum housing with silicone o-rings providing a superior weather-tight seal	Durable cast aluminum housing with silicone o-rings providing a superior weather-tight seal
SOCKET	E26	E26

Item 54000 and 55000 BZ accept LED PAR16, LED PAR20, or LED E26 lamps. For line voltage accessories, see page 102.



**15288 BK**  
120V TAPER™ BOLLARD  
6" SQ., 36" H  
  

**15288 BZ**  
120V TAPER™ BOLLARD  
6" SQ., 36" H  
  

**15288 TT**  
120V TAPER™ BOLLARD  
6" SQ., 36" H  
  

**55607 BK**  
120V SHELTER™ BOLLARD  
4" W, 30" H, 3" D  
 

**DESIGN  
NOTE**

Taper Bollards include  
120V/277V universal driver.

 LED ITEM	LED ENGINE (INCLUDED)	MAX WATTAGE	LUMENS	COLOR TEMP.	HALOGEN EQUIV.	LIFESPAN	FINISH	CONSTRUCTION	LENS
15288 BK	GL-3030	28w	2800	3000K	4-60w	40,000 hrs	Black	Aluminum	
15288 BZ	GL-3030	28w	2800	3000K	4-60w	40,000 hrs	Bronze	Aluminum	
15288 TT	GL-3030	28w	2800	3000K	4-60w	40,000 hrs	Titanium	Aluminum	
55607 BK	00G3SE120V-50	8w	550	3000K	50w	60,000 hrs	Black	Aluminum	Clear Acrylic Outside Cylinder Seedy Glass Inside Panel

Photometrics for bollards are based off of engine photometrics. See page 110. A wiring kit, 2" diameter, 18" length PVC post and surface mount are supplied. For line voltage accessories, see page 102. For transformers, see page 104.



**DESIGN  
NOTE**

All large LED bollards feature the LumaCORE system, which has a **LIFETIME WARRANTY**.



**55601 BZ**  
120V ATLANTIS™  
ROUND BOLLARD  
3" DIA., 30" H



**55601 TT**  
120V ATLANTIS™  
ROUND BOLLARD  
3" DIA., 30" H



**55602 BZ**  
120V ATLANTIS™  
SQUARE BOLLARD  
3" SQ., 30" H



**55602 TT**  
120V ATLANTIS™  
SQUARE BOLLARD  
3" SQ., 30" H



LED ITEM	LED ENGINE (INCLUDED)	MAX WATTAGE	LUMENS	COLOR TEMP.	HALOGEN EQUIV.	LIFESPAN	FINISH	CONSTRUCTION	LENS
<b>55601 BZ</b>	00G3SE120V-50	8w	550	3000K	50w	60,000 hrs	Bronze	Aluminum	Etched
<b>55601 TT</b>	00G3SE120V-50	8w	550	3000K	50w	60,000 hrs	Titanium	Aluminum	Etched
<b>55602 BZ</b>	00G3SE120V-50	8w	550	3000K	50w	60,000 hrs	Bronze	Aluminum	Etched
<b>55602 TT</b>	00G3SE120V-50	8w	550	3000K	50w	60,000 hrs	Titanium	Aluminum	Etched

Photometrics for bollards are based off of engine photometrics. See page 110. A wiring kit, 2" diameter, 18" length PVC post and surface mount are supplied. For line voltage accessories, see page 102. For transformers, see page 104.

STEP LIGHT

# THE LUNA™ LED

Hinkley's Luna LED Step Light offers an ideal solution for illuminating some of the darkest and busiest areas of your home, like Steps and Hallways, which are often at a disadvantage by not having any sources of natural light. Rated for indoor or outdoor use, this Decorator sized step light includes a contemporary styled radius front die cast face plate.

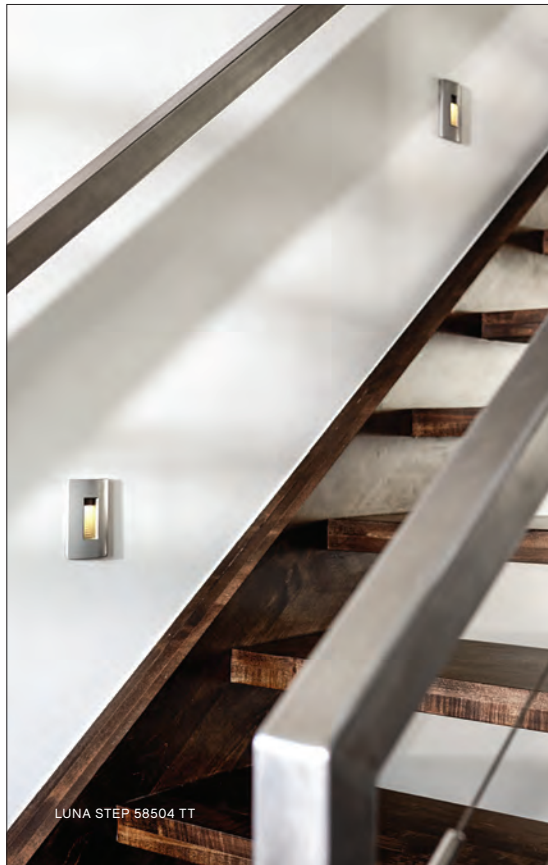

LUNA STEP 58504 TT

LUNA LED STEP LIGHT FEATURES:

Available in 2700K or 3000K

Dimmable

4w Power Consumption

Fits Single or Double Gang  
Junction Box

Die Cast Zinc Aluminum Alloy

Rated for Indoor/Outdoor Use

Accepts all Decorator Switch  
Plate Covers

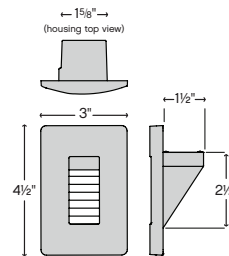

**58504 BZ**  
120V LUNA STEP LIGHT  
3" W, 4 1/2" H



**58504 SW**  
120V LUNA STEP LIGHT  
3" W, 4 1/2" H



**58504 SK**  
120V LUNA STEP LIGHT  
3" W, 4 1/2" H



**58504 TT**  
120V LUNA STEP LIGHT  
3" W, 4 1/2" H

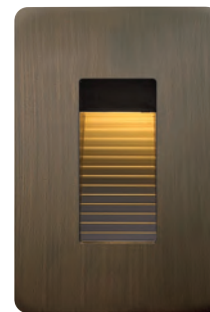

**58504 MZ**  
120V LUNA STEP LIGHT  
3" W, 4 1/2" H

LED ITEM	LED ENGINE (INCLUDED)	MAX WATTAGE	LUMENS	COLOR TEMP.	HALOGEN EQUIV.	LIFESPAN	FINISH	CONSTRUCTION
58504 BZ	LS-20	4w	240	2700K	20w	40,000 hrs	Bronze	Zinc Aluminum Alloy
58504 MZ	LS-20	4w	240	2700K	20w	40,000 hrs	Matte Bronze	Forged Brass Face Plate
58504 SK	LS-20	4w	240	2700K	20w	40,000 hrs	Satin Black	Zinc Aluminum Alloy
58504 SW	LS-20	4w	240	2700K	20w	40,000 hrs	Satin White	Zinc Aluminum Alloy
58504 TT	LS-20	4w	240	2700K	20w	40,000 hrs	Titanium	Zinc Aluminum Alloy

A wiring kit is supplied. For line voltage accessories, see page 102.

**PHOTOMETRICS** (BASED ON VARIOUS MOUNTING HEIGHTS)

DISTANCE FROM LIGHT		LED ITEM	1'	2'	3'	4'	5'	6'	7'	8'
FOOT CANDLES	8" Mounting	58504 BZ	6.36	1.01	0.22					
	16" Mounting		2.6	1.65	0.67	0.3	0.13			
	30" Mounting		0.16	1.1	0.69	0.4	0.23	0.13		
	8" Mounting	58504 MZ	6.74	1.12	0.24					
	16" Mounting		2.73	1.82	0.73	0.31	0.14			
	30" Mounting			1.22	0.76	0.40	0.23	0.12		
	8" Mounting	58504 SK	6.36	1.01	0.22					
	16" Mounting		2.6	1.65	0.67	0.3	0.13			
	30" Mounting		0.16	1.1	0.69	0.4	0.23	0.13		
	8" Mounting	58504 SW	9.29	2.6	1.17	0.64	0.42	0.29	0.21	0.16
	16" Mounting		3.0	2.32	1.17	0.66	0.41	0.28	0.2	0.15
	30" Mounting		0.25	1.19	0.93	0.6	0.4	0.29	0.21	0.16
	8" Mounting	58504 TT	9.05	2.2	0.83	0.4	0.25	0.16	0.11	
	16" Mounting		3.16	2.17	0.97	0.49	0.27	0.16	0.1	
	30" Mounting		0.1	1.29	0.86	0.52	0.33	0.22	0.15	0.1



# THE LUNA STEP LIGHT

The Luna step light is the perfect addition to any interior or exterior lighting plan. Luna seamlessly blends into the home and illuminates stairs, walkways or patio spaces. Now available in Satin Black and select 120V models in 3000K.



LUNA STEP 58504 BZ

## FEATURES + BENEFITS

- 4w power consumption
- Die cast zinc aluminum alloy
- Fits single or double gang junction box
- Rated for Indoor/Outdoor Use
- Accepts all decorator style switch plate covers
- 120V Available in 2700K or 3000K
- Dimmable

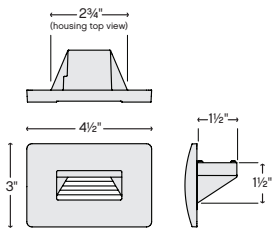

**58508 BZ3K**  
120V LUNA  
STEP LIGHT 2700K  
4 1/2" W, 3" H



**58508 SK3K**  
120V LUNA  
STEP LIGHT 2700K  
4 1/2" W, 3" H



**58508 SW3K**  
120V LUNA  
STEP LIGHT 2700K  
4 1/2" W, 3" H



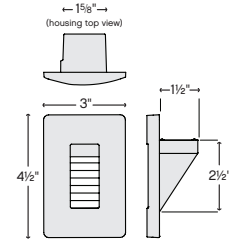

**58504 BZ3K**  
120V LUNA  
STEP LIGHT 3000K  
3" W, 4 1/2" H



**58504 SK3K**  
120V LUNA  
STEP LIGHT 3000K  
3" W, 4 1/2" H



**58504 SW3K**  
120V LUNA  
STEP LIGHT 3000K  
3" W, 4 1/2" H

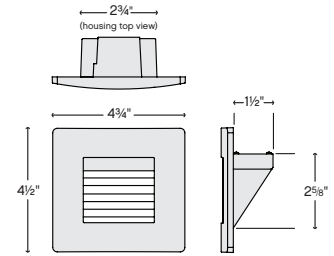

**58506 BZ3K**  
120V LUNA STEP LIGHT  
3000K DOUBLE GANG  
4 3/4" W, 4 1/2" H



**58506 SK3K**  
120V LUNA STEP LIGHT  
3000K DOUBLE GANG  
4 3/4" W, 4 1/2" H



**58506 SW3K**  
120V LUNA STEP LIGHT  
3000K DOUBLE GANG  
4 3/4" W, 4 1/2" H



### LUNA STEP LIGHT 120V LED VERTICAL

LED ITEM	LED ENGINE (INCLUDED)	MAX WATTAGE	LUMENS	COLOR TEMP.	HALOGEN EQUIV.	LIFESPAN	FINISH	CONSTRUCTION
58504 BZ3K	LS-20-30	4w	240	3000K	20w	40,000 hrs	Bronze	Zinc Aluminum Alloy
58504 SK3K	LS-20-30	4w	240	3000K	20w	40,000 hrs	Satin Black	Zinc Aluminum Alloy
58504 SW3K	LS-20-30	4w	240	3000K	20w	40,000 hrs	Satin White	Zinc Aluminum Alloy

A wiring kit is supplied. For line voltage accessories, see page 102.

### LUNA STEP LIGHT 120V LED HORIZONTAL DOUBLE GANG

LED ITEM	LED ENGINE (INCLUDED)	MAX WATTAGE	LUMENS	COLOR TEMP.	HALOGEN EQUIV.	LIFESPAN	FINISH	CONSTRUCTION
58506 BZ3K	LS-20-30	4w	240	3000K	20w	40,000 hrs	Bronze	Zinc Aluminum Alloy
58506 SK3K	LS-20-30	4w	240	3000K	20w	40,000 hrs	Satin Black	Zinc Aluminum Alloy
58506 SW3K	LS-20-30	4w	240	3000K	20w	40,000 hrs	Satin White	Zinc Aluminum Alloy

A wiring kit is supplied. For line voltage accessories, see page 102.

### LUNA STEP LIGHT 120V LED HORIZONTAL

LED ITEM	LED ENGINE (INCLUDED)	MAX WATTAGE	LUMENS	COLOR TEMP.	HALOGEN EQUIV.	LIFESPAN	FINISH	CONSTRUCTION
58508 BZ3K	LS-20-30	4w	240	3000K	20w	40,000 hrs	Bronze	Zinc Aluminum Alloy
58508 SK3K	LS-20-30	4w	240	3000K	20w	40,000 hrs	Satin Black	Zinc Aluminum Alloy
58508 SW3K	LS-20-30	4w	240	3000K	20w	40,000 hrs	Satin White	Zinc Aluminum Alloy

A wiring kit is supplied. For line voltage accessories, see page 102.



**58508 BZ**  
120V LUNA™ STEP LIGHT  
4½" W, 3" H



**58508 SK**  
120V LUNA™ STEP LIGHT  
4½" W, 3" H



**58508 MZ**  
120V LUNA™ STEP LIGHT  
4½" W, 3" H



**58508 SW**  
120V LUNA™ STEP LIGHT  
4½" W, 3" H



**58508 TT**  
120V LUNA™ STEP LIGHT  
4½" W, 3" H

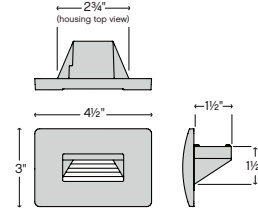

LED ITEM	LED ENGINE (INCLUDED)	MAX WATTAGE	LUMENS	COLOR TEMP.	HALOGEN EQUIV.	LIFESPAN	FINISH	CONSTRUCTION
<b>58508 BZ</b>	LS-20	4w	240	2700K	20w	40,000 hrs	Bronze	Zinc Aluminum Alloy
<b>58508 MZ</b>	LS-20	4w	240	2700K	20w	40,000 hrs	Matte Bronze	Forged Brass Face Plate
<b>58508 SK</b>	LS-20	4w	240	2700K	20w	40,000 hrs	Satin Black	Zinc Aluminum Alloy
<b>58508 SW</b>	LS-20	4w	240	2700K	20w	40,000 hrs	Satin White	Zinc Aluminum Alloy
<b>58508 TT</b>	LS-20	4w	240	2700K	20w	40,000 hrs	Titanium	Zinc Aluminum Alloy

A wiring kit is supplied. For line voltage accessories, see page 102.

**PHOTOMETRICS** (BASED ON VARIOUS MOUNTING HEIGHTS)

DISTANCE FROM LIGHT		LED ITEM	1'	2'	3'	4'	5'	6'	7'	8'	
FOOT CANDLES	8" Mounting	58508 BZ	3.58	0.71	0.2						
	16" Mounting			0.86	0.38	0.15					
	30" Mounting				0.27	0.24	0.13				
	8" Mounting	58508 MZ	3.79	0.79	0.23						
	16" Mounting			0.90	0.41	0.17					
	30" Mounting				0.33	0.29	0.14				
	6" Mounting	58508 SK	1.08	0.03	0.01						
	18" Mounting			0.62	0.55	0.08	0.01				
	30" Mounting			0.07	0.26	0.21	0.11	0.03	0.01		
	8" Mounting	58508 SW	7.0	2.19	0.97	0.57	0.37	0.26	0.19	0.14	
	16" Mounting			0.66	0.158	0.85	0.5	0.32	0.23	0.16	0.12
	30" Mounting				0.32	0.52	0.43	0.3	0.23	0.16	0.12
	8" Mounting	58508 TT	4.5	1.8	0.45	0.25	0.15	0.11			
	16" Mounting				1.03	0.54	0.27	0.15	0.1		
	30" Mounting					0.32	0.29	0.19	0.12		





**58506 SK**  
120V LUNA™ STEP LIGHT  
4¾" W, 4½" H



**58506 BZ**  
120V LUNA™ STEP LIGHT  
4¾" W, 4½" H



**58506 SW**  
120V LUNA™ STEP LIGHT  
4¾" W, 4½" H

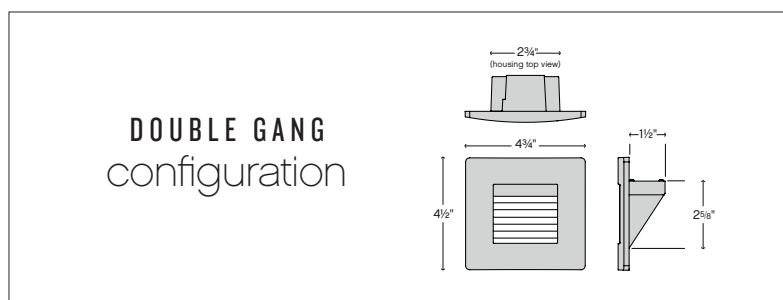

**58506 TT**  
120V LUNA™ STEP LIGHT  
4¾" W, 4½" H



LED ITEM	LED ENGINE	MAX WATTAGE	LUMENS	COLOR TEMP.	HALOGEN EQUIV.	LIFESPAN	FINISH	CONSTRUCTION
<b>58506 BZ</b>	LS-20	4w	240	2700K	20w	40,000 hrs	Bronze	Zinc Aluminum Alloy
<b>58506 SK</b>	LS-20	4w	240	2700K	20w	40,000 hrs	Satin Black	Zinc Aluminum Alloy
<b>58506 SW</b>	LS-20	4w	240	2700K	20w	40,000 hrs	Satin White	Zinc Aluminum Alloy
<b>58506 TT</b>	LS-20	4w	240	2700K	20w	40,000 hrs	Titanium	Zinc Aluminum Alloy

A wiring kit is supplied. For line voltage accessories, see page 102.

**PHOTOMETRICS** (BASED ON VARIOUS MOUNTING HEIGHTS)

DISTANCE FROM LIGHT		LED ITEM	1'	2'	3'	4'	5'
FOOT CANDLES	8" Mounting	58506 BZ	4.76	0.47	0.08		
	16" Mounting		2.24	0.92	0.17	0.06	
	30" Mounting		1.08	0.65	0.21	0.11	0.03
	6" Mounting	58506 SK	0.99	0.02	0.01		
	18" Mounting		2.04	0.42	0.06	0.01	
	30" Mounting		0.98	0.64	0.19	0.05	0.01
	8" Mounting	58506 SW	7.15	0.89	0.20	0.08	
	16" Mounting		3.22	0.77	0.31	0.14	0.07
	30" Mounting		2.12	0.81	0.26	0.15	0.06
	8" Mounting	58506 TT	6.86	0.70	0.16	0.06	
	16" Mounting		2.97	1.13	0.39	0.11	0.05
	30" Mounting		1.88	0.95	0.23	0.14	0.06

# TERRACE SIGN LIGHTS

Dimmable  
Available in two sizes  
Wet rated

Rated for floor, wall or ceiling mount  
(floor mounting is allowed for interior dry/damp applications only)

Two extension rod lengths included

The unique design of the sleek Terrace sign light can accomplish a wide variety of lighting applications.

## DESIGN NOTE

Terrace sign lights are engineered with cutting-edge SunLike Series natural spectrum LEDs, which produce light that closely matches that of natural sunlight. This innovative technology ensures that any artwork or signage that is being illuminated will appear just as vibrant at night as during the day.



**15062 BZ**  
TERRACE SHORT SIGN LIGHT  
16½" W, 7¾" H, 6" EXT. (SHOWN)

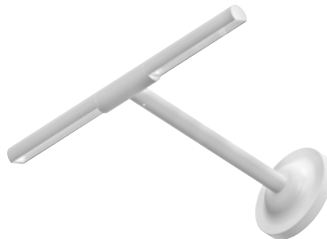

**15062 MW**  
TERRACE SHORT SIGN LIGHT  
16½" W, 7¾" H, 12" EXT. (SHOWN)



**15063 BZ**  
TERRACE LONG SIGN LIGHT  
28½" W, 13¾" H, 12" EXT. (SHOWN)

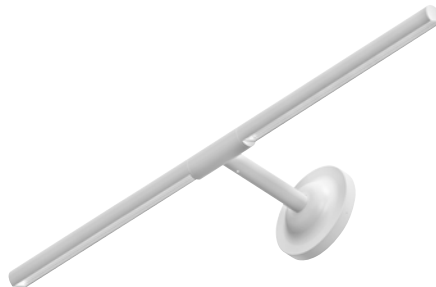

**15063 MW**  
TERRACE LONG SIGN LIGHT  
16½" W, 7¾" H, 6" EXT. (SHOWN)

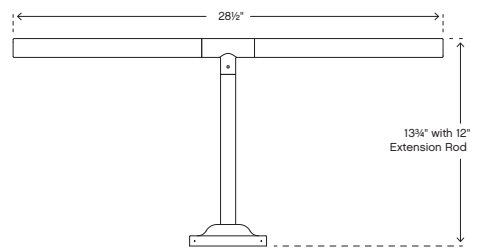
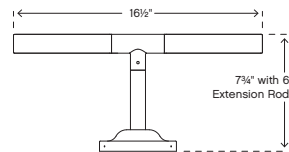
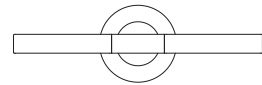
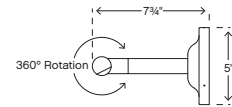

LED ITEM	LED ENGINE (INCLUDED)	MAX WATTAGE	LUMENS	COLOR TEMP.	HALOGEN EQUIV.	LIFESPAN	FINISH	CONSTRUCTION	BACK PLATE	GLASS	EXT. RODS INCLUDED
15062 BZ	EAL6.5LEDBZ	6.5w	1200	3000K	2 x 60w	60,000 hrs	Bronze	Aluminum	5¼" Dia. x 1½" H	Clear	1 -6", 1-12"
15062 MW	EAL6.5LEDMW	6.5w	1200	3000K	2 x 60w	60,000 hrs	Matte White	Aluminum	5¼" Dia. x 1½" H	Clear	1 -6", 1-12"
15063 BZ	EAL12.5LEDBZ	12.5w	2400	3000K	2 x 75w	60,000 hrs	Bronze	Aluminum	5¼" Dia. x 1½" H	Clear	1 -6", 1-12"
15063 MW	EAL12.5LEDMW	12.5w	2400	3000K	2 x 75w	60,000 hrs	Matte White	Aluminum	5¼" Dia. x 1½" H	Clear	1 -6", 1-12"

A wiring kit is supplied. For complete product details and LED specifications, visit [Hinkley.com](http://Hinkley.com).



**59024 BZ-LL**  
120V LED  
BRICK LIGHT  
10" W, 3½" H, 4¼" D  
 

**59040 BZ**  
120V 40W G9  
BRICK LIGHT  
10" W, 3½" H, 4¼" D  

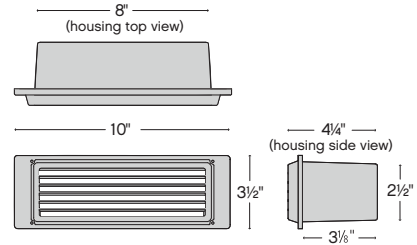

**58015 BZ-LL**  
120V LED  
STEP LIGHT  
7½" W, 4¾" H, 3¼" D  
 

**58025 BZ**  
120V 25W G9  
STEP LIGHT  
7½" W, 4¾" H, 3¼" D  

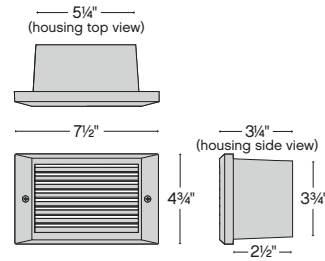
ITEM	59024 BZ-LL	59040 BZ	58015 BZ-LL	58025 BZ
NAME	120v LED Brick Light	Brick Light (40w) G9	120v LED Step Light	Step Light (25w) G9
FINISH	Powder-Coated Bronze (BZ)	Powder-Coated Bronze (BZ)	Powder-Coated Bronze (BZ)	Powder-Coated Bronze (BZ)
CONSTRUCTION	Cast aluminum with a silicone gasket providing a superior weather-tight seal	Cast aluminum with a silicone gasket providing a superior weather-tight seal	Cast aluminum with a silicone gasket providing a superior weather-tight seal	Cast aluminum with a silicone gasket providing a superior weather-tight seal
LENS	Clear, Flat	Frosted, Flat	Frosted, Flat	Frosted, Flat
VOLTAGE	120v	120v	120v	120v
LAMP/LED ENGINE	3.8w NX3 Included	up to 40w G9 (not included) or up to 5w G9 LED (not included)	3.8w NX3 Included	up to 25w G9 (not included) or up to 3w G9 LED (no included)
WIRING/WIRING COMPARTMENT	6" usable 200°C 18-AWG wire leads and ground leads	6" usable 200°C 18-AWG wire leads and ground leads	6" usable 200°C 18-AWG wire leads and ground leads	6" usable 200°C 18-AWG wire leads and ground leads
SOCKET		White Porcelain Bi-Pin Base		White Porcelain Bi-Pin Base

For line voltage accessories, see page 102.

**PHOTOMETRICS** (BASED ON VARIOUS MOUNTING HEIGHTS)

DISTANCE FROM LIGHT		ITEM/LED ITEM	1'	2'	3'	4'	5'	6'	7'	8'	9'
FOOT CANDLES	6" Mounting	59024 BZ-LL	3.32	0.68	0.15	0.03	0.01				
	18" Mounting		0.02	0.52	0.32	0.19	0.09	0.04	0.02	0.01	
	30" Mounting		0.03	0.04	0.19	0.17	0.12	0.06	0.04	0.02	0.01
	6" Mounting	59040 BZ	10.20	3.55	1.58	0.68	0.08				
	12" Mounting		4.25	3.61	3.48	1.79	0.53	0.32	0.25	0.18	0.11
	18" Mounting		1.15	1.06	0.89	0.68	0.64	0.58	0.41	0.25	0.15
	6" Mounting	58015 BZ-LL	10.33	1.73	0.4	0.14	0.05				
	18" Mounting		1.53	2.06	1.02	0.53	0.32	0.17	0.12	0.5	0.03
	30" Mounting		0.13	0.76	0.84	0.61	0.35	0.24	0.15	0.09	0.06
	6" Mounting	58025 BZ	16.37	3.84	0.99	0.33	0.11	0.03	0.20	0.10	
18" Mounting	3.25		2.37	1.82	1.16	0.52	0.30	0.21	0.10		



## PAR LAMP WELL LIGHTS

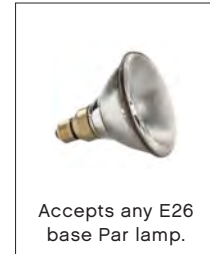
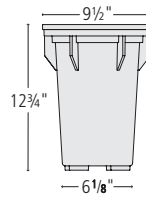

**51000 BZ**  
 120V 100W SM.  
 IN-GROUND WELL LIGHT  
 9½" DIA., 12¾" H  
 6⅛" DIA. BASE



<b>ITEM</b>	<b>51000 BZ</b>
FINISH	Bronze (BZ)
CONSTRUCTION	Thermoplastic composite resin with molded ribbing to prevent ground shifting.
LENS	Clear, Flat
VOLTAGE	120v
LAMP (NOT INCLUDED)	up to 100w Incandescent Par Lamp
LED LAMP (NOT INCLUDED)	up to 14w LED
WIRING/WIRING COMPARTMENT	6" usable 105°C 18-AWG wire leads and ground leads. Isolated sealable wiring compartment. Cover has (2) threaded ¾"-14NPS entries for conduit re-attachment. Encapsulant potting compound included.
GASKET	EPDM 1-piece Molded Silicone U-Channel
REFLECTOR	120° Hydroformed Alzak-Finished Aluminum
SOCKET	E26
LIVE LOAD CAPACITY	2200 lbs.
ACCESSORIES	Small Concrete Kit: 51010 CK Small Rock Guard: 51901 BZ

# LUMACORE™ WELL LIGHT

Introducing 120V well lights compatible with LumaCore™, Hinkley's expert LED Accent Lighting system, backed by industry leading lifetime warranty.



**TILT ADJUSTABLE**  
+/- 20°

**DESIGN NOTE**

Light source cradle tilts 20° in both directions for optimal beam angling

## FEATURES + BENEFITS

- + SOLID CAST BRASS AVAILABLE IN MATTE BRONZE OR DURABLE ALUMINUM CONSTRUCTION IN BRONZE
- + ACCEPTS LUMACORE™ LED
- + 55702 IS DRIVE OVER RATED
- + THREE LENS OPTIONS (20°, 40°, 60°) INCLUDED OFFER VERSATILITY IN BEAM SPREAD VIA AN EASY TO REMOVE AND INSERT OPTIC ASSEMBLY
- + HARDY ISLAND LIFETIME WARRANTY
- + LUMACORE™ LIFETIME WARRANTY



**55702 BZ3K**  
FLAT TOP WELL LIGHT  
3000K  
4 1/2" W, 4" H



**55702 MZ3K**  
HARDY ISLAND™  
FLAT TOP WELL LIGHT  
3000K  
4 1/2" W, 4" H



**55702 BZ27K**  
FLAT TOP WELL LIGHT  
2700K  
4 1/2" W, 4" H



**55702 MZ27K**  
HARDY ISLAND™  
FLAT TOP WELL LIGHT  
2700K  
4 1/2" W, 4" H



LED ITEM	LED ENGINE (INCLUDED)	MAX WATTAGE	LUMENS	COLOR TEMP.	HALOGEN EQUIV.	LIFESPAN	FINISH	CONSTRUCTION	LENS
55702 BZ27K	27G3SE120V-75	12w	750	2700K	60w	40,000 hrs	Bronze	Aluminum	Clear
55702 BZ3K	00G3SE120V-75	12w	750	3000K	60w	40,000 hrs	Bronze	Aluminum	Clear
55702 MZ27K	27G3SE120V-75	12w	750	2700K	60w	40,000 hrs	Matte Bronze	Cast Brass*	Clear
55702 MZ3K	00G3SE120V-75	12w	750	3000K	60w	40,000 hrs	Matte Bronze	Cast Brass*	Clear

\*Exposed cover is Hardy Island Cast Brass and base is Aluminum. Installed with 40° lens.

# 120V ACCESSORIES



**50500 PP**  
POWER POST



**50200 WN**  
WIRE CONNECTORS



**0022 BZ**  
JUNCTION BOX COVER  
4½" DIA., ¾" H

ITEM	50200 WN	50500 PP	0022 BZ
NAME	Silicone Wire Connectors	Power Post	Junction Box Cover
DESCRIPTION	Outdoor Wire Connectors	Landscape Splice Post with Junction Box	
WIDTH/DIAMETER	5/8" Dia.	3/4" Dia. 7" W (with fins)	
HEIGHT		20½"	
LENGTH	1¼"		
DETAILS	Package of 20	PVC	
FINISH			Bronze (BZ)
CONSTRUCTION			Aluminum





# 12V ACCESSORIES

HARDY ISLAND PATH LIGHTS 16022 MZ-LL, PAGE 47  
SPOT LIGHTS 1536 MZ, PAGE 22



ENERGY EFFICIENCY + SECURITY + CONVENIENCE

# GET SMART

---

Hinkley Transformers are Compatible with Smart Technology



These days, there's a smart phone app to do just about everything. Forget to shut off the lights before leaving for vacation? Weary of pulling into a dark driveway at night? Sick of paying sky-high energy bills? With smart home technology, lighting controls are just a few taps away on your smart phone.

A smart home system can provide energy efficiency, security and convenience at any time and place. Hinkley transformers can be integrated with existing wireless systems without the need of an electrician or tech expert. They are compatible with a variety of smart home automation kits such as Lutron Caséta, Legrand, Samsung Smart Things and Insteon. Hinkley transformers are also compatible with outdoor smart switch devices, such as GE's Wink Plug-In Switch and TP-Link's Smart Plug.

#### INTEGRATING INTO EXISTING SMART HOME TECHNOLOGY

For homes that already use smart technology, adding Hinkley Landscape Lighting into the current system is easy. Before purchasing the smart home lighting kit, research it to ensure compatibility with the existing network protocol.

#### TIP

MAKE SURE THE DEVICE CAN WITHSTAND OUTDOOR ENVIRONMENTAL CONDITIONS IN YOUR CLIMATE ZONE, SUCH AS HEAT AND DAMPNESS. WEATHER-RESISTANCE IS KEY.

Once a kit has been purchased, download its corresponding app and connect the device to the Hinkley transformer. Within minutes, Hinkley Landscape Lighting can be programmed to turn on and off within a set schedule, or automatically turn on and off with sunrise and sunset.

#### PLUG IN & PLAY OPTION

Not ready to go full smart home? Consider buying an outdoor smart switch device, which allow wireless programming and controls without existing smart technology. Be sure to buy a device compatible with the smart phone's operating platform (like iOS or Android) then download the device app. Plug the Hinkley transformer directly into the smart switch, and the smart switch directly into the transformer.

#### TIP

THINK OF A SMART SWITCH AS AN ADAPTOR – THE HINKLEY TRANSFORMER PLUGS INTO THE SWITCH DEVICE, AND THE SWITCH DEVICE PLUGS INTO THE POWER SUPPLY.

#### ECO KINDNESS FROM HINKLEY

Smart technology is just one way to keep energy efficiency in-check. For more eco-kindness tips from Hinkley, visit [Hinkley.com/Blog](http://Hinkley.com/Blog).

**HINKLEY TRANSFORMERS ARE COMPATIBLE WITH BOTH SMART HOME AUTOMATION KITS AND OUTDOOR SMART PLUG/SWITCH DEVICES**

MANY SMART HOME TECHNOLOGY OPTIONS ARE AVAILABLE.

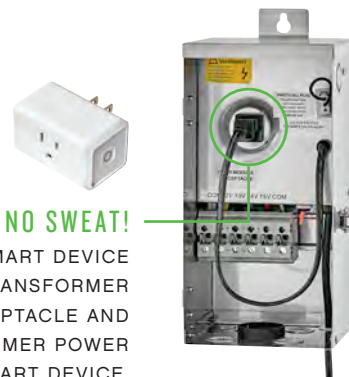

**NO SWEAT!**

PLUG A SMART DEVICE INTO THE TRANSFORMER TIMER RECEPTACLE AND THE TRANSFORMER POWER INTO THE SMART DEVICE.

## POWER TRIP

When calculating your landscape lighting budget, consider the full scope of the project even if you are planning to do it in phases. In most cases it's wise to invest in a larger transformer than you'll initially need so you can add more light sources as your landscape matures, water or architectural features are added in or your outdoor living areas expand. We recommend allowing for an extra 20% capacity to accommodate these kinds of additions down the road.

**FOR ADDITIONAL INFORMATION** ON SELECTING THE PROPER TRANSFORMER, VIEW THE DESIGN + INSTALLATION GUIDES ON PAGE 118.



For additional information on how to select the proper transformer, view the **DESIGN + INSTALLATION GUIDES** on page 118.

**STANDARD TRANSFORMER**



**0150 BK**  
150W STANDARD TRANSFORMER

**PRO-SERIES™ TRANSFORMERS**



**0075W SS**  
75W PRO-SERIES™  
TRANSFORMER



**0150 SS**  
150W PRO-SERIES™  
TRANSFORMER



**0300 SS**  
300W PRO-SERIES™  
TRANSFORMER



**0600 SS**  
600W PRO-SERIES™  
TRANSFORMER



**0900 SS**  
900W PRO-SERIES™  
TRANSFORMER

**TRANSFORMER CONTROLLERS**



**1505 TC**  
STANDARD  
TIME CLOCK



**0200 LT**  
DIGITAL ASTRONOMICAL  
TIME CLOCK



**1503 PH**  
DIRECT MOUNT  
PHOTOCELL



**1510 PH**  
PHOTOCELL WITH  
10' LEAD WIRE

ITEM	NAME	CONSTRUCTION	FINISH	WIDTH	HEIGHT	DEPTH	WATTAGE (VA)	TAP
<b>0075W SS</b>	75w Pro-Series Transformer	Stainless Steel		6½"	13¼"	5½"	75w	12v+15v only
<b>0150 BK</b>	150w Standard Transformer	Composite Resin	Black	4¼"	6¼"	3¾"	150w	12v
<b>0150 SS</b>	150w Pro-Series Transformer	Stainless Steel		6½"	13¼"	5½"	150w	12v+15v only
<b>0200 LT</b>	Digital Astronomical Time Clock		Black	3⅞"	3¼"	2⅞"		
<b>0300 SS</b>	300w Pro-Series Transformer	Stainless Steel		6½"	18"	6"	300w	12v-15v
<b>0600 SS</b>	600w Pro-Series Transformer	Stainless Steel		6½"	18"	6"	600w	12v-15v
<b>0900 SS</b>	900w Pro-Series Transformer	Stainless Steel		8½"	18"	7"	900w	12v-15v
<b>1503 PH</b>	Direct Mount Photocell		Black					
<b>1505 TC</b>	Standard Time Clock		Black	2¾"	3⅞"	2¼"		
<b>1510 PH</b>	Photocell with 10' Lead Wire		Black					

TRANSFORMER FEATURE GUIDE	STANDARD TRANSFORMER	PRO-SERIES™ TRANSFORMERS				
						
STYLE	COMPOSITE RESIN	STAINLESS STEEL	STAINLESS STEEL	STAINLESS STEEL	STAINLESS STEEL	STAINLESS STEEL
MODEL	<b>0150 BK</b>	<b>0075W SS</b>	<b>0150 SS</b>	<b>0300 SS</b>	<b>0600 SS</b>	<b>0900 SS</b>
WATTAGE	150	75	150	300	600	900
BLACK COMPOSITE RESIN	✓					
STAINLESS STEEL		✓	✓	✓	✓	✓
12V-15V MULTI-TAP	12v only	12v + 15v only	12v + 15v only	✓	✓	✓
AUTOMATIC TIMER (4H, 6H, 8H)	✓					
MODULAR TIMER AVAILABLE		✓	✓	✓	✓	✓
PHOTOCELL	✓					
MODULAR PHOTOCELL AVAILABLE		✓	✓	✓	✓	✓
AUTO ON/OFF SWITCH	✓					
3' LINE CORD	✓	✓	✓	✓	✓	✓
BOTTOM PLATE		✓	✓	✓	✓	✓
THERMAL CUT-OFF PRIMARY SIDE	✓	✓	✓	✓	✓	✓
THERMAL RESET SECONDARY	✓					
MAGNETIC RESET SECONDARY		✓	✓	✓	✓	✓
STANDARD TERMINAL BLOCK	✓					
HIGH CAPACITY TERMINAL BLOCK		✓	✓	✓	✓	✓
10-YEAR WARRANTY	✓					
LIFETIME WARRANTY		✓	✓	✓	✓	✓



**16990 MZ**  
90° STEM MOUNT  
1" DIA., 24¾" H



**16918 MZ, 16910 MZ**  
STEM MOUNTS  
1" DIA., 18", 10" H



**50200 WN**  
WIRE CONNECTORS  
5/8" DIA., 1¼" H



**16807 MZ**  
CAST BRASS SURFACE MOUNT  
2¾" DIA., 1¼" H



**0015 BZ**  
SURFACE MOUNT  
3½" DIA., 1¼" H



**0005 BK**  
STEM COUPLER  
1" DIA., 1⅞" H



**0100 FT, 0250 FT**  
WIRE



**1507 QC**  
QUICK CONNECT  
1" W, ¾" H, 2" D



**0021 BZ**  
TREE MOUNT  
3" W, 1¾" H, 4¾" D

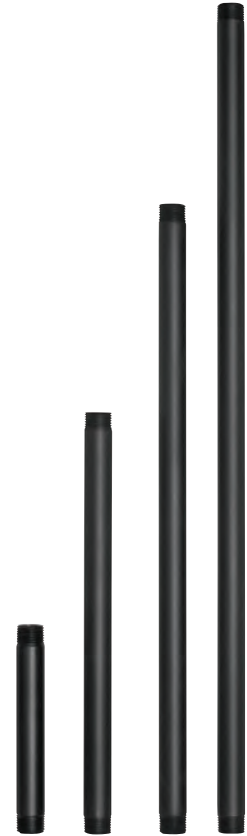

**0006-TBK, 0012-TBK, 0018-TBK, 0024-TBK**  
PATH LIGHT STEMS  
¾" DIA., 6", 12", 18", 24" H

ITEM	NAME	FINISH	CONSTRUCTION
0005 BK	Coupler	Black	Aluminum
0006-TBK	6" Path Light Stem	Black	Aluminum
0012-TBK	12" Path Light Stem	Black	Aluminum
0015 BZ	Surface Mount	Bronze	Cast Aluminum
0018-TBK	18" Path Light Stem	Black	Aluminum
0021BZ	Tree Mount	Bronze	Cast Aluminum
0022 BZ	Junction Box Cover	Bronze	Aluminum
0024-TBK	24" Path Light Stem	Black	Aluminum
0100 FT	100' Wire (12 AWG)	Black	Stranded 2-Wire
0250 FT	250' Wire (12 AWG)	Black	Stranded 2-Wire
1507 QC	Quick Connect	Black	Composite
16807 MZ	Cast Brass Surface Mount	Matte Bronze	Cast Brass
16910 MZ	10" Stem Mount	Matte Bronze	Cast Brass
16918 MZ	18" Stem Mount	Matte Bronze	Cast Brass
16990 MZ	24" 90° Mount Stem	Matte Bronze	Cast Brass
50200 WN	Wire Connectors (20 pack)		Silicone



PERFORMANCE LENSES



**0016 CB**  
CORRECTIVE BLUE LENS  
2" DIA., 1/8" D  
Enhances color;  
creates moonlight effect

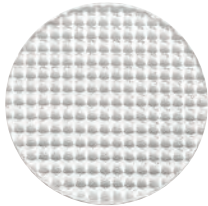

**0016 PF**  
PRISMATIC FILTER LENS  
2" DIA., 1/8" D  
Diffuses lamp  
beam spread

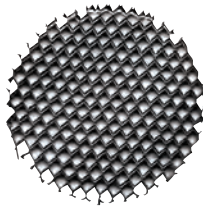

**0016 HL**  
HEX LOUVER LENS  
2" DIA., 1/8" D  
Reduces overall glare

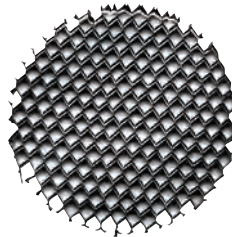

**0037 HL**  
HEX LOUVER LENS  
3" DIA., 1/8" D  
Reduces overall glare

**0016 LENSES**  
are used with the following  
spotlights: 1535, 1536 series,  
1583 NC

**0037 HEX LOUVER LENS**  
is used with 54000,  
15702, 15705, 15708

Lenses come in packages of 6.



**16814 BZ**  
HEAVY DUTY  
GROUND SPIKE  
2 3/4" DIA., 16" H



**16814 MZ**  
HEAVY DUTY  
GROUND SPIKE  
2 3/4" DIA., 16" H



**0019 BZ**  
GROUND SPIKE  
2" W, 15" H



**0013-JBBZ**  
GROUND SPIKE  
2" W, 9" H



**0014 BZ**  
GROUND SPIKE  
2 3/4" W, 9" H

ITEM	NAME	FINISH	CONSTRUCTION
0013-JBBZ	Ground Spike with Junction Box	Bronze	Cast Aluminum
0014 BZ	Ground Spike	Bronze	Composite
0016 CB	Corrective Blue Lens (6 pack)		Glass
0016 HL	Hex Louver Lens (6 pack)		Aluminum
0016 PF	Prismatic Filter Lens (6 pack)		Glass
0019 BZ	Ground Spike	Bronze	Composite
0037 HL	Hex Louver Lens (6 pack)		Aluminum
16814 BZ	Heavy Duty Ground Spike	Bronze	Aluminum/Composite
16814 MZ	Heavy Duty Ground Spike	Matte Bronze	Brass/Composite

TRUSTED PERFORMANCE IN OUTDOOR ILLUMINATION SINCE 1922.

# LUMACORE™ PHOTOMETRICS



## PHOTOMETRIC GUIDE

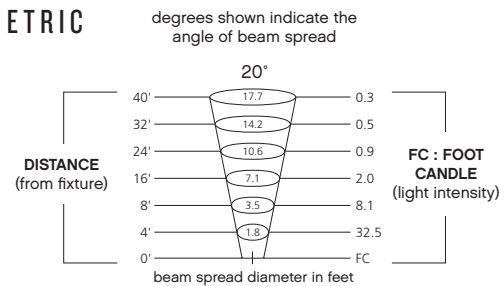

**LED ENGINES** AVAILABLE IN 3W, 5W, 8W AND 12W

### 2700K

27G3SE-20, 27G3SE-35,  
27G3SE-50, 27G3SE-75

2700K 3W, 5W, 8W,  
12W LED

### 3000K

00G3SE-20, 00G3SE-35,  
00G3SE-50, 00G3SE-75

3000K 3W, 5W, 8W,  
12W LED

## 3 LENS OPTIONS OFFER VERSATILITY IN BEAM SPREAD

via an easy to remove  
and insert optic assembly



20° SPOT



40° FLOOD



60° WIDE FLOOD

## FOR 1536 + 1535 SERIES SPOT AND MODULAR WELL LIGHTS

### 1536 + 1535 SERIES SPOT LIGHTS



1536 MZ

1535 BZ

### MODULAR WELL LIGHTS



15702 BZ

15705 MZ

15708 BZ

# FIELD CHANGEABLE LENS OPTIONS



## 20° SPOT LENS

AVAILABLE IN 3W, 5W, 8W + 12W OPTIONS | 2700K + 3000K COLOR TEMPERATURES

3W   XXG3SE-20		5W   XXG3SE-35		8W   XXG3SE-50		12W   XXG3SE-75	
LUMENS	CANDLE POWER	LUMENS	CANDLE POWER	LUMENS	CANDLE POWER	LUMENS	CANDLE POWER
260	884	400	1360	546	1856	749	2547
<p>20° 40' 17.7 0.6 32' 14.2 0.9 24' 10.6 1.5 16' 7.1 3.5 8' 3.5 13.8 4' 1.8 55.3 0' FC beam spread diameter in feet</p>		<p>20° 40' 17.7 0.9 32' 14.2 1.3 24' 10.6 2.4 16' 7.1 5.3 8' 3.5 21.3 4' 1.8 85.0 0' FC beam spread diameter in feet</p>		<p>20° 40' 17.7 1.2 32' 14.2 1.8 24' 10.6 3.2 16' 7.1 7.3 8' 3.5 29.0 4' 1.8 116.0 0' FC beam spread diameter in feet</p>		<p>20° 40' 17.7 1.6 32' 14.2 2.5 24' 10.6 4.4 16' 7.1 9.9 8' 3.5 39.8 4' 1.8 159.2 0' FC beam spread diameter in feet</p>	



## 40° FLOOD LENS

AVAILABLE IN 3W, 5W, 8W + 12W OPTIONS | 2700K + 3000K COLOR TEMPERATURES

3W   XXG3SE-20		5W   XXG3SE-35		8W   XXG3SE-50		12W   XXG3SE-75	
LUMENS	CANDLE POWER	LUMENS	CANDLE POWER	LUMENS	CANDLE POWER	LUMENS	CANDLE POWER
272	381	419	587	571	799	784	1098
<p>40° 40' 29.1 0.2 32' 23.3 0.4 24' 17.5 0.7 16' 11.6 1.5 8' 5.8 6.0 4' 2.9 23.8 0' FC beam spread diameter in feet</p>		<p>40° 40' 29.1 0.4 32' 23.3 0.6 24' 17.5 1.0 16' 11.6 2.3 8' 5.8 9.2 4' 2.9 36.7 0' FC beam spread diameter in feet</p>		<p>40° 40' 29.1 0.5 32' 23.3 0.8 24' 17.5 1.4 16' 11.6 3.1 8' 5.8 12.5 4' 2.9 49.9 0' FC beam spread diameter in feet</p>		<p>40° 40' 29.1 0.7 32' 23.3 1.1 24' 17.5 1.9 16' 11.6 4.3 8' 5.8 17.2 4' 2.9 68.6 0' FC beam spread diameter in feet</p>	



## 60° WIDE FLOOD LENS

AVAILABLE IN 3W, 5W, 8W + 12W OPTIONS | 2700K + 3000K COLOR TEMPERATURES

3W   XXG3SE-20		5W   XXG3SE-35		8W   XXG3SE-50		12W   XXG3SE-75	
LUMENS	CANDLE POWER	LUMENS	CANDLE POWER	LUMENS	CANDLE POWER	LUMENS	CANDLE POWER
260	260	400	400	546	546	749	749
<p>60° 40' 46.2 0.2 32' 36.9 0.3 24' 27.7 0.5 16' 18.5 1.0 8' 9.2 4.1 4' 4.6 16.3 0' FC beam spread diameter in feet</p>		<p>60° 40' 46.2 0.3 32' 36.9 0.4 24' 27.7 0.7 16' 18.5 1.6 8' 9.2 6.3 4' 4.6 25.0 0' FC beam spread diameter in feet</p>		<p>60° 40' 46.2 0.3 32' 36.9 0.5 24' 27.7 0.9 16' 18.5 2.1 8' 9.2 8.5 4' 4.6 34.1 0' FC beam spread diameter in feet</p>		<p>60° 40' 46.2 0.5 32' 36.9 0.7 24' 27.7 1.3 16' 18.5 2.9 8' 9.2 11.7 4' 4.6 46.8 0' FC beam spread diameter in feet</p>	



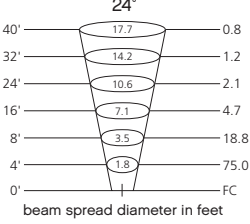

# 12 VOLT LED PAR36 LAMPS

FOR USE IN THE 1598BK, 1598MZ-FT, AND 1598MZ-RG WELL LIGHTS

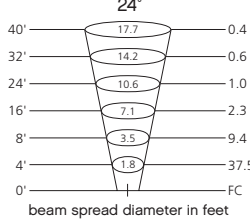
13W27K24-PAR36		MR16 LED	PHOTOMETRICS
	WATTAGE	13w	 <p>beam spread diameter in feet</p>
	BEAM SPREAD	24°	
	COLOR TEMP.	2700K	
	LUMENS	800	
	CANDLE POWER	1200	
	BASE	ARI11	
	LIFESPAN	25,000 hrs	

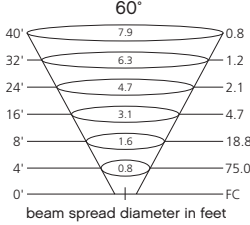
6W27K24-PAR36		MR16 LED	PHOTOMETRICS
	WATTAGE	6w	 <p>beam spread diameter in feet</p>
	BEAM SPREAD	24°	
	COLOR TEMP.	2700K	
	LUMENS	400	
	CANDLE POWER	600	
	BASE	ARI11	
	LIFESPAN	25,000 hrs	

13W27K60-PAR36		MR16 LED	PHOTOMETRICS
	WATTAGE	13w	 <p>beam spread diameter in feet</p>
	BEAM SPREAD	60°	
	COLOR TEMP.	2700K	
	LUMENS	800	
	CANDLE POWER	934	
	BASE	ARI11	
	LIFESPAN	25,000 hrs	

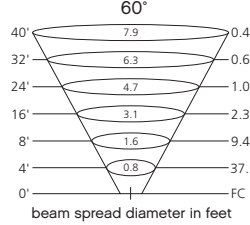
6W27K60-PAR36		MR16 LED	PHOTOMETRICS
	WATTAGE	6w	 <p>beam spread diameter in feet</p>
	BEAM SPREAD	60°	
	COLOR TEMP.	2700K	
	LUMENS	400	
	CANDLE POWER	467	
	BASE	ARI11	
	LIFESPAN	25,000 hrs	

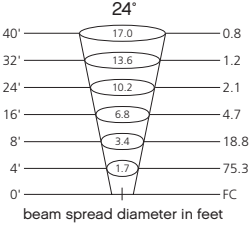
13W30K24-PAR36		MR16 LED	PHOTOMETRICS
	WATTAGE	13w	 <p>beam spread diameter in feet</p>
	BEAM SPREAD	24°	
	COLOR TEMP.	3000K	
	LUMENS	810	
	CANDLE POWER	1205	
	BASE	ARI11	
	LIFESPAN	25,000 hrs	

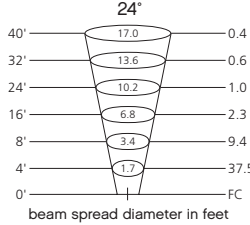
6W30K24-PAR36		MR16 LED	PHOTOMETRICS
	WATTAGE	6w	 <p>beam spread diameter in feet</p>
	BEAM SPREAD	24°	
	COLOR TEMP.	3000K	
	LUMENS	405	
	CANDLE POWER	607	
	BASE	ARI11	
	LIFESPAN	25,000 hrs	

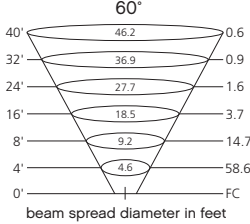
13W30K60-PAR36		MR16 LED	PHOTOMETRICS
	WATTAGE	13w	 <p>beam spread diameter in feet</p>
	BEAM SPREAD	60°	
	COLOR TEMP.	3000K	
	LUMENS	810	
	CANDLE POWER	938	
	BASE	ARI11	
	LIFESPAN	25,000 hrs	

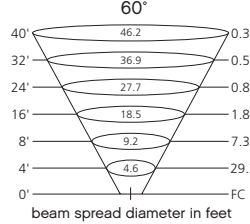
6W30K60-PAR36		MR16 LED	PHOTOMETRICS
	WATTAGE	6w	 <p>beam spread diameter in feet</p>
	BEAM SPREAD	60°	
	COLOR TEMP.	3000K	
	LUMENS	405	
	CANDLE POWER	469	
	BASE	ARI11	
	LIFESPAN	25,000 hrs	

**DESIGN NOTE**

One side is cut away for angling beam direction

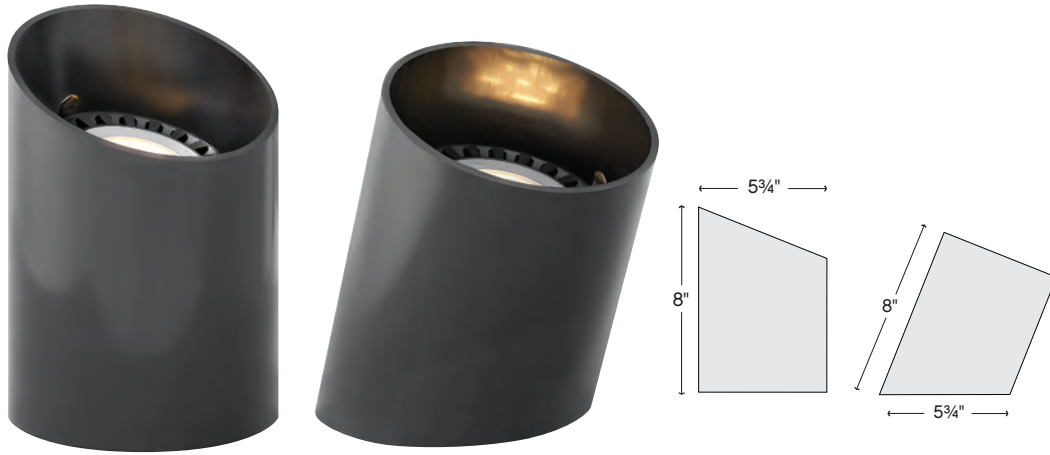

**1598 BK**  
REVERSIBLE PAR36 WELL LIGHT  
5 3/4" DIA., 8" H

**TILT ADJUSTABLE**  
+/- 20°

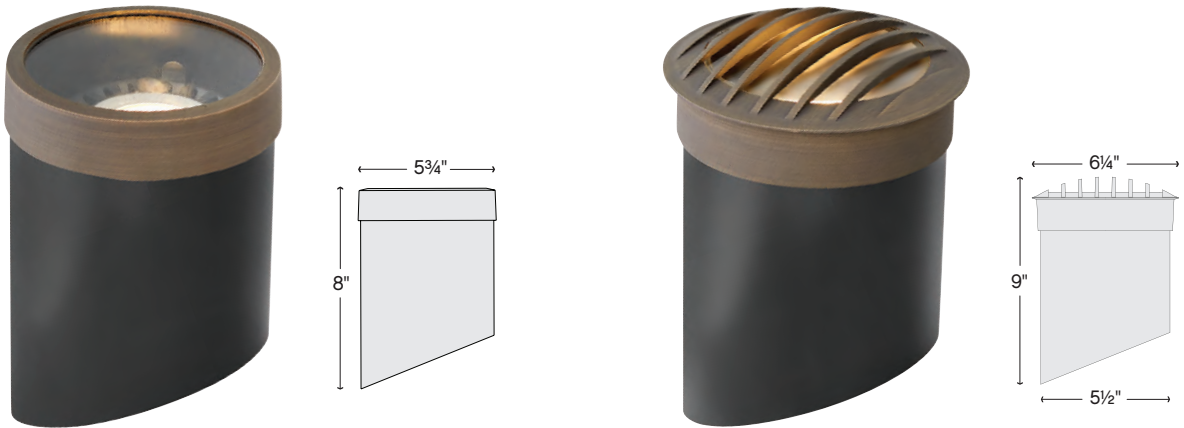

**1598 MZ-FT**  
HARDY ISLAND™  
FLAT TOP PAR36 WELL LIGHT  
5 3/4" DIA., 8" H



**1598 MZ-RG**  
HARDY ISLAND™  
ROCK GUARD PAR36 WELL LIGHT  
6 1/4" DIA., 9" H





ITEM	LAMP (NOT INCLUDED)	MAX WATTAGE	LED LAMP (NOT INCLUDED)	FINISH	CONSTRUCTION	LENS
1598 BK	PAR36	35w	PAR 36 LED	Black	PVC and Stainless Steel	
1598 MZ-FT	PAR36	35w	PAR 36 LED	Matte Bronze	PVC and Brass	Clear
1598 MZ-RG	PAR36	35w	PAR 36 LED	Matte Bronze	PVC and Brass	Clear

A wiring kit is supplied. For accessories, see page 108. For transformers, see page 104. LED PAR36 sold separately.

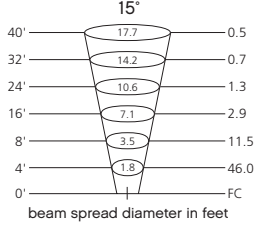
# 12 VOLT LED LAMPS

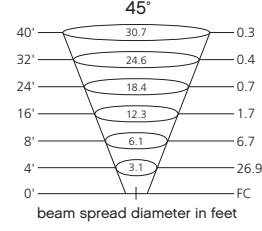
4W27K15	MR16 LED		PHOTOMETRICS
	WATTAGE	4w	 <p>15°</p> <p>beam spread diameter in feet</p>
	BEAM SPREAD	15°	
	COLOR TEMP.	2700K	
	LUMENS	240	
	CANDLE POWER	736	
	BASE	Bi-Pin	
	LIFESPAN	50,000 hrs	

4W27K45	MR16 LED		PHOTOMETRICS
	WATTAGE	4w	 <p>45°</p> <p>beam spread diameter in feet</p>
	BEAM SPREAD	45°	
	COLOR TEMP.	2700K	
	LUMENS	240	
	CANDLE POWER	430	
	BASE	Bi-Pin	
	LIFESPAN	50,000 hrs	

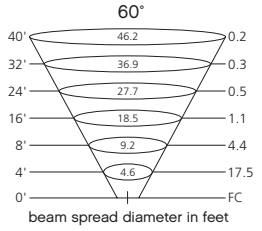
4W27K60	MR16 LED		PHOTOMETRICS
	WATTAGE	4w	 <p>60°</p> <p>beam spread diameter in feet</p>
	BEAM SPREAD	60°	
	COLOR TEMP.	2700K	
	LUMENS	240	
	CANDLE POWER	280	
	BASE	Bi-Pin	
	LIFESPAN	50,000 hrs	

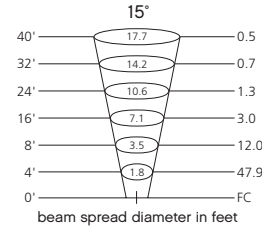
4W3K15	MR16 LED		PHOTOMETRICS
	WATTAGE	2w	 <p>15°</p> <p>beam spread diameter in feet</p>
	BEAM SPREAD	15°	
	COLOR TEMP.	3000K	
	LUMENS	250	
	CANDLE POWER	767	
	BASE	Bi-Pin	
	LIFESPAN	50,000 hrs	

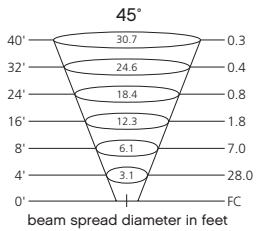
4W3K45	MR16 LED		PHOTOMETRICS
	WATTAGE	4w	 <p>45°</p> <p>beam spread diameter in feet</p>
	BEAM SPREAD	45°	
	COLOR TEMP.	3000K	
	LUMENS	250	
	CANDLE POWER	448	
	BASE	Bi-Pin	
	LIFESPAN	50,000 hrs	

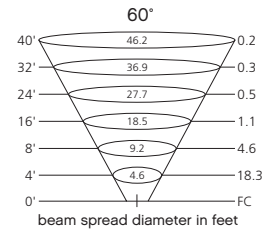
4W3K60	MR16 LED		PHOTOMETRICS
	WATTAGE	4w	 <p>60°</p> <p>beam spread diameter in feet</p>
	BEAM SPREAD	60°	
	COLOR TEMP.	3000K	
	LUMENS	250	
	CANDLE POWER	292	
	BASE	Bi-Pin	
	LIFESPAN	50,000 hrs	

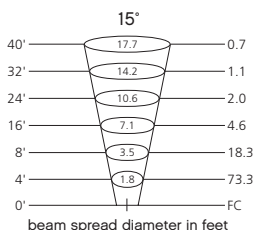
6W27K15	MR16 LED		PHOTOMETRICS
	WATTAGE	6w	 <p>15°</p> <p>beam spread diameter in feet</p>
	BEAM SPREAD	15°	
	COLOR TEMP.	2700K	
	LUMENS	450	
	CANDLE POWER	1172	
	BASE	Bi-Pin	
	LIFESPAN	50,000 hrs	

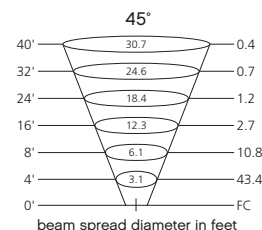
6W27K45	MR16 LED		PHOTOMETRICS
	WATTAGE	56w	 <p>45°</p> <p>beam spread diameter in feet</p>
	BEAM SPREAD	45°	
	COLOR TEMP.	2700K	
	LUMENS	450	
	CANDLE POWER	694	
	BASE	Bi-Pin	
	LIFESPAN	50,000 hrs	

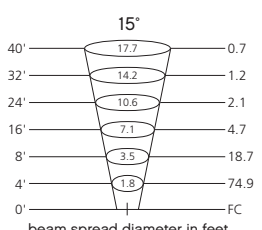
6W3K15	MR16 LED		PHOTOMETRICS
	WATTAGE	6w	 <p>15°</p> <p>beam spread diameter in feet</p>
	BEAM SPREAD	15°	
	COLOR TEMP.	3000K	
	LUMENS	460	
	CANDLE POWER	1198	
	BASE	Bi-Pin	
	LIFESPAN	50,000 hrs	

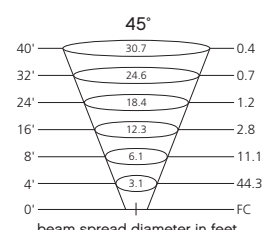
6W3K45	MR16 LED		PHOTOMETRICS
	WATTAGE	6w	 <p>45°</p> <p>beam spread diameter in feet</p>
	BEAM SPREAD	45°	
	COLOR TEMP.	3000K	
	LUMENS	460	
	CANDLE POWER	709	
	BASE	Bi-Pin	
	LIFESPAN	50,000 hrs	



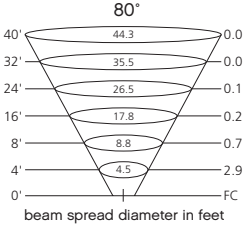

# 12 VOLT LED LAMPS

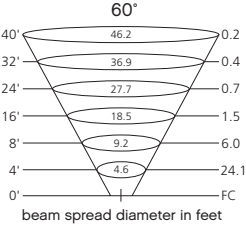
MR827K	MR8 LED		PHOTOMETRICS
	WATTAGE	2.5w	 <p>80° beam spread diameter in feet</p>
	BEAM SPREAD	80°	
	COLOR TEMP.	2700K	
	LUMENS	92	
	CANDLE POWER	46	
	BASE	Bi-Pin	
	LIFESPAN	50,000 hrs	

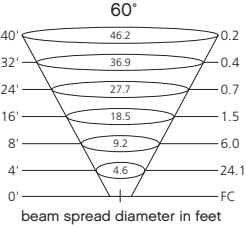
MR1127K	MR11 LED		PHOTOMETRICS
	WATTAGE	4w	 <p>60° beam spread diameter in feet</p>
	BEAM SPREAD	60°	
	COLOR TEMP.	2700K	
	LUMENS	350	
	CANDLE POWER	385	
	BASE	Bi-Pin	
	LIFESPAN	50,000 hrs	

MR1127K-3W			PHOTOMETRICS
	WATTAGE	4w / 4VA	 <p>60° beam spread diameter in feet</p>
	BEAM SPREAD	60°	
	COLOR TEMP.	2700K	
	LUMENS	350	
	CANDLE POWER	385	
	BASE	G4	
	LIFESPAN	15,000 hrs	

T3 LED REPLACEMENT	00T3-27LED	00T3-LED	
	WATTAGE	1.5w / 1.8VA	1.5w / 1.8VA
	BEAM SPREAD	360°	360°
	COLOR TEMP.	2700K	3000K
	LUMENS	140	140
	BASE	Bi-Pin	Bi-Pin
	LIFESPAN	35,000 hrs	35,000 hrs

T5 LED REPLACEMENT	00T5-27LED	00T5-LED	
	WATTAGE	1.7w / 2.0VA	1.7w / 2.0VA
	BEAM SPREAD	360°	360°
	COLOR TEMP.	2700K	3000K
	LUMENS	180	180
	BASE	Wedge	Wedge
	LIFESPAN	35,000 hrs	35,000 hrs

T3 LED REPLACEMENT	00T3-27LED-1.5	
	WATTAGE	1.5w / 1.8VA
	BEAM SPREAD	360°
	COLOR TEMP.	2700K
	LUMENS	150
	BASE	G4
	LIFESPAN	25,000 hrs

T5 LED REPLACEMENT	00T5-27LED-1.5	00T5-27LED-2.5	
	WATTAGE	1.5w / 1.8VA	2.5w / 4.6VA
	BEAM SPREAD	360°	360°
	COLOR TEMP.	2700K	2700K
	LUMENS	150	250
	BASE	G4	G4
	LIFESPAN	25,000 hrs	25,000 hrs

# 12 VOLT LED LAMPS

12 VOLT MEDIUM BASE		E26LED12V
	WATTAGE	3.5w
	VOLT AMPS	4.6VA
	LUMENS	360
	COLOR TEMP.	2700K
	CRI	80
	HALOGEN EQUIV.	1 x 35W
	LIFESPAN	15,000 hrs
	BASE	E26
	DIMMABLE	Yes - MLV On Transformer Primary

12 VOLT CANDELABRA BASE		E12LED12V
	WATTAGE	3.5w
	VOLT AMPS	4.7VA
	LUMENS	360
	COLOR TEMP.	2700K
	CRI	80
	HALOGEN EQUIV.	1 x 35W
	LIFESPAN	15,000 hrs
	BASE	E12
	DIMMABLE	Yes - MLV On Transformer Primary

EA-LMW		-1.5W	-2.5W
	BULB INPUT	12VAC	12VAC
	WATTAGE	1.5w / 2.5VA	2.5w / 3.8VA
	LUMENS	150	250
	COLOR TEMP.	2700K	2700K
	CRI	80	80
	HALOGEN EQUIV.	1 x 25W	1 x 25W
	LIFESPAN	40,000 hrs	40,000 hrs
	BASE	Mini-Wedge	Mini-Wedge
	DIMMABLE	Yes - MLV On Transformer Primary	Yes - MLV On Transformer Primary

# LUMACORE™ ENGINES

12V 00G3SE		-20	-35	-50	-75
	WATTAGE	3w / 3.2VA	5w / 5.3VA	8w / 7.8VA	12w / 12.4VA
	LUMENS	260	350	475	750
	COLOR TEMP.	3000K	3000K	3000K	3000K
	CRI	80	80	80	80
	HALOGEN EQUIV.	1 x 25w	1 x 35w	1 x 45w	1 x 60w
	LIFESPAN	60,000 hrs	60,000 hrs	60,000 hrs	40,000 hrs
	BASE	G5.3	G5.3	G5.3	G5.3

120V 00G3SE120V		-75
	WATTAGE	12w
	LUMENS	750
	COLOR TEMP.	3000K
	CRI	80
	HALOGEN EQUIV.	1 x 60w
	LIFESPAN	40,000 hrs
	BASE	G5.3

12V 27G3SE		-20	-35	-50	-75
	WATTAGE	3w / 3.2VA	5w / 5.3VA	8w / 7.8VA	12w / 12.4VA
	LUMENS	260	350	475	750
	COLOR TEMP.	2700K	2700K	2700K	2700K
	CRI	80	80	80	80
	HALOGEN EQUIV.	1 x 25w	1 x 35w	1 x 45w	1 x 60w
	LIFESPAN	60,000 hrs	60,000 hrs	60,000 hrs	40,000 hrs
	BASE	G5.3	G5.3	G5.3	G5.3

120V 27G3SE120V-75		-75
	WATTAGE	12w
	LUMENS	750
	COLOR TEMP.	2700K
	CRI	80
	HALOGEN EQUIV.	1 x 60w
	LIFESPAN	40,000 hrs
	BASE	G5.3



# 12V LED LOW VOLTAGE DESIGN + INSTALLATION

## STEP 1: MAKE A PLAN

What do you want to light? Pick favorite trees, interesting plants, fountains, statues or other attractive architectural elements. These items will be the focus of your lighting plan. Think about how you use the property. Are there areas you would like to illuminate for work, recreation or entertaining? Think about areas in which added light would enhance safety, such as steps or a wall around the side of your home.

### *helpful planning tip*

DON'T MISS THE LANDSCAPE LIGHTING TECHNIQUES ON PAGES 6-7 TO DETERMINE THE BEST METHODS FOR HIGHLIGHTING YOUR HOME'S EXTERIOR.



ARC 15714TT, PAGE 30

## STEP 2: PREPARE YOUR EQUIPMENT

### LOW VOLTAGE LED SYSTEMS

Most residential LED landscape lighting is done with 12-volt distribution. The system consists of a central transformer, weatherproof cable and low voltage LED fixtures and accessories.

### LED FIXTURES

Decide on what fixtures you will be using as part of your complete lighting plan. Choose styles you like and select the appropriate LED WATTAGE for the application.

### TRANSFORMERS

Transformers convert your 120-volt household current to 12-volt. Outdoor transformers can be installed on the side of your house and plug into an exterior rated outlet. They must mount at least 12" above the ground.

Transformers used indoors (such as in a garage or basement) must be listed for that application. For indoor use, UL requires conduit be used when running wiring through the wall. Calculate the total volt amperage (VA) your system requires. Then choose a transformer powerful enough to handle the total VA and still have some extra capacity if fixtures will be added at a later time.

### CABLE

12-volt LED fixtures take power from a weatherproof, flexible 2-wire cable that can be used above or below ground and generally does not need to be housed in conduit or buried as deep as 120-volt wiring. 12AWG cable is minimum gauge recommended for LED installations. Measure the distance from the last fixture on the run to the transformer to calculate the amount of cable needed. Add 1-2 feet of cable per fixture to allow for repositioning.

## STEP 3: WIRING YOUR SYSTEM

## CABLE FIXTURE AND LAYOUT

If your lighting plan requires more than one transformer, you will need to divide the fixtures into groups or zones. To do so, consider the many areas of your property and how they are used. You may want all of the front yard lighting on one transformer, patio and deck lighting on another transformer, etc. The location of your electrical outlets will also help you to determine how to group the fixtures.

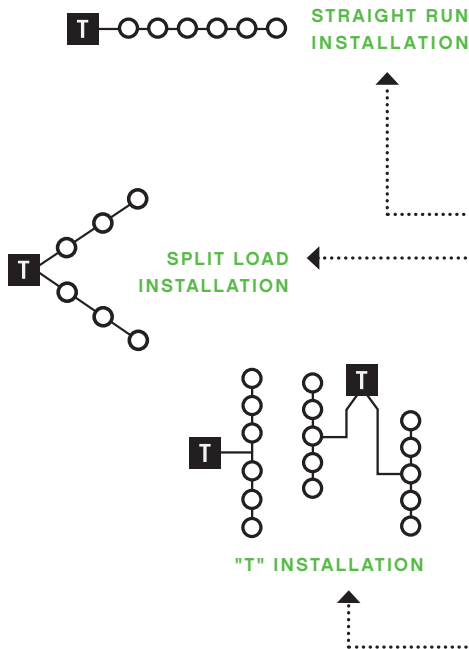

The pictured diagrams will help you wire your system. The black box represents the transformer.

**STRAIGHT RUN INSTALLATION**

Fixtures run in sequence directly from the transformer.

**SPLIT LOAD INSTALLATION**

With a Split Load installation, fixtures run in two or more directions from the transformer. Locate the transformer in the center of the run and connect wires to the transformer as you would when using straight run installation.

**"T" INSTALLATION**

A "T" installation allows more equal distribution of power to the center of the run, or to the run some distance away. For lengthy runs, use 8 or 10 AWG cable to split. Use 12 AWG cable to cross the "T" between fixtures.

**MINIMAL VOLTAGE DROP WITH LED**

LED fixtures use less amperage than incandescent, therefore more fixtures can be used in a single cable run as compared to incandescent. Each fixture has a built-in durable driver circuit that accepts a wider input voltage range (10VAC-15VAC) thus eliminating the common voltage-drop problems experienced with incandescent systems. Most fixtures can be wired in straight run installations eliminating the need to create zones or split loads. The driver in each fixture will regulate the input voltage and properly power the LED.

**VA (VOLT-AMPS) & W (WATTAGE)**

All LED fixtures are measured in wattage (the actual electric consumed by the LED) and volt-amps VA (the power supply required to operate the LED). LED drivers convert the 12V alternating current (AC) to direct current (DC) to power the LED chip(s). This additional power to change the current is measured as volt-amps (VA) for each fixture. The VA indicates the power supply or transformer requirement you will need to operate the LEDs. To properly size your transformer, add up the VA for all fixtures on the system. To calculate your energy cost, add up the measured wattage rating of each LED.

$$6 \text{ fixtures} \times 2.1 \text{ W each} = 12.6 \text{ W total}$$

(ACTUAL ENERGY CONSUMED)

$$6 \text{ fixtures} \times 3.2 \text{ VA each} = 19.2 \text{ VA total}$$

(MINIMUM TRANSFORMER REQUIRED)

*for further instructions* ON FIXTURE CONNECTION, MOUNTING AND ACCESSORIES, FOLLOW HINKLEY'S INCANDESCENT INSTALLATION INSTRUCTIONS FOUND ON PAG 118.

# 12V LED LOW VOLTAGE DESIGN + INSTALLATION

## STEP 3: WIRING YOUR SYSTEM (CONTINUED)

### CABLE FIXTURE AND LAYOUT

If your lighting plan requires more than one transformer, you will need to divide the fixtures into groups or zones. To do so, consider the many areas of your property and how they are used. You may want all of the front yard lighting on one transformer, patio and deck lighting on another transformer, etc. The location of your electrical outlets will also help you to determine how to group the fixtures.

MAXIMUM CABLE LENGTH PER TOTAL FIXTURE WATTS/VA							
Cable Size	50w/VA	75w/VA	100w/VA	150w/VA	200w/VA	250w/VA	300w/VA
12-2	300'	200'	150'	100'	75'	60'	—
10-2	475'	318'	240'	160'	120'	100'	80'
8-2	750'	506'	380'	250'	190'	150'	125'

### VOLTAGE DROP

Excessive voltage drop occurs when too much wattage is placed on a cable that is too long or too small for the load. Voltage drop causes lamps furthest from the transformer to be dimmer than those near the transformer.

To help minimize voltage drop among each group of fixtures, use the following information to assist you:

**Total Watts** = sum of the incandescent wattage on a single run of wire.

**Volt Amps** = sum of the LED VA on a single run of wire.

**Cable Length** = length of cable run (feet) from the transformer to the last fixture on that run.

**Cable Constant** = thickness of copper wire. The thicker the wire, the lower the conductive resistance, resulting in a lower drop in voltage.

THE CABLE CONSTANT IS BASED ON WIRE SIZE. REMEMBER THAT LARGER WIRES HAVE LOWER AWG SIZES.

CABLE CONSTANT	
Cable	Constant
18 AWG	1,380v
16 AWG	2,200v
14 AWG	3,500v
12 AWG	7,500v
10 AWG	11,920v
8 AWG	18,960v

### CALCULATING VOLTAGE DROP

You can calculate voltage drop in volts using the formula below. It also shows the relationship of wattage/VA, run length and two-conductor cable size (given by the cable constant). Adjust lamp wattage/VA, number of fixtures per run, or the length of the run to maintain the right relationship. Example: (3) 50w fixtures on a 75 ft. run using 12 gauge wire.

$$\text{VOLTAGE DROP} = \frac{\text{Total Watts/VA} \times \text{Cable Length}}{\text{Cable Constant}} \times 2$$

### EXAMPLE:

$$\text{VOLTAGE DROP} = \frac{150\text{w} \times 75'}{7500 \text{ (12 AWG Cable Constant)}} \times 2$$

Then, subtract the voltage drop from transformer output to operate in desired range:

$$15 \text{ VOLT TAP} - 3 \text{ (VOLTAGE DROP)} = 12 \text{ (ACTUAL VOLTAGE)}$$

Voltage should not drop below 10.8 volts. In this case you should choose higher outputs to keep voltage in desired range of 11.2 volts-11.6 volts.

Lighting fixtures will generate heat. To avoid excessive heat be sure to keep all lamps clear of dirt and debris. Input voltage at the lamp on low voltage fixtures should never exceed 12 volts.



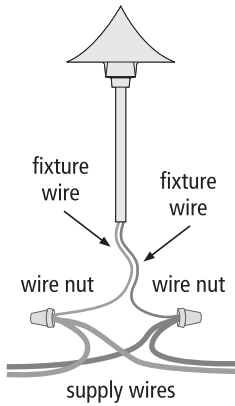

#### FIXTURE CONNECTION

Hinkley low voltage fixtures come standard with a connection kit, (2) wire nuts and silicone caulk. Fixtures should be attached by splicing them into main supply cable. Wire nuts should be filled with silicone. Twist the wires, then screw on the wire nut. Wrap with electrical tape. Bury any extra wire at the base of fixture to allow for relocation or adjustment.

After wiring your lighting plan, turn the transformer on and check the lamp voltage at each fixture.

#### MOUNTING

Hinkley low-voltage fixtures come standard with the 0014 BZ ground spike (see accessories, page 109) and can be easily relocated every several years to adjust for the natural growth of trees and plantings.

## STEP 4: COMPLETE INSTALLATION

Controls enhance landscape lighting, just as they do interior lighting. Photocells, timers and special lenses can help control your lighting plan.



#### PHOTOCELLS

Photocells turn the lighting on when the sun goes down. You can combine a photocell (on) and a timer (off) to avoid wasting energy after the household has retired for the night.

#### TIMERS

Timers provide automatic on/off control, according to how you program them and can be used in conjunction with photocells.

#### LENSES

Hinkley lenses are available for use with spotlights to create directional beams of light, diffuse lamp beam spread, enhance color and to reduce overall glare.

*for additional accessories* AND CONTROLS, SEE PAGE 103.





0906	115	1403 OC-LL	53	1535 BZ-5W27K	17	15446 TT-10	59	1566 DZ-LL	43
0912	115	1437 DZ-LV	78	1535 BZ-5W3K	17	15448 BZ	58	1566 OZ-LL	43
0921	115	1437 RB-LV	78	1535 BZ-8W27K	17	15448 ST	58	1567 RY-LL	53
0005 BK	108	15014 BZ-LL	45	1535 BZ-8W3K	17	15448 TT	58	1568 RB-LL	54
0006-TBK	108	15014 HE-LL	45	1535 MZ	22	1546 BZ-LL	63	15702 BZ	26
0012-TBK	108	15014 MZ-LL	45	1535 MZ-12W27K	17	1546 MZ-LL	63	15702 BZ-12W27K	19
0013-JBBZ	109	15014 SK-LL	45	1535 MZ-12W3K	17	1547 BK-LL	50	15702 BZ-12W3K	19
0014 BZ	109	15014 TT-LL	45	1535 MZ-3W27K	17	1547 KZ-LL	50	15702 BZ-3W27K	19
0015 BZ	108	1502 BZ-LL	42	1535 MZ-3W3K	17	1548 BZ-LL	41	15702 BZ-3W3K	19
0016 CB	109	1502 CY-LL	42	1535 MZ-5W27K	17	1548 SK-LL	41	15702 BZ-5W27K	19
0016 HL	109	1503 PH	106	1535 MZ-5W3K	17	1548 TT-LL	41	15702 BZ-5W3K	19
0016 PF	109	15030 OZ-LL	39	1535 MZ-8W27K	17	1550 BZ	42	15702 BZ-8W27K	19
0018-TBK	108	15030 TK-LL	39	1535 MZ-8W3K	17	15501 BZ	35	15702 BZ-8W3K	19
0019 BZ	109	1504 BZ	51	1536 BN-DN	23	15501 TT	35	15702 MZ-12W27K	21
0021BZ	108	1505 TC	106	1536 BZ	22	15502 BZ	35	15702 MZ-12W3K	21
0022 BZ	102	15062 BZ	98	1536 BZ-12W27K	17	15502 TT	35	15702 MZ-3W27K	21
0022 BZ	108	15062 MW	98	1536 BZ-12W3K	17	15508 BK	69	15702 MZ-3W3K	21
0024-TBK	108	15063 BZ	98	1536 BZ-3W27K	17	15508 BZ	69	15702 MZ-5W27K	21
0037 HL	109	15063 MW	98	1536 BZ-3W3K	17	15508 MZ	69	15702 MZ-5W3K	21
0075W SS	106	1507 QC	108	1536 BZ-5W27K	17	15508 SW	69	15702 MZ-8W27K	21
00G3SE	117	1508 CB-LL	54	1536 BZ-5W3K	17	15508 TT	69	15702 MZ-8W3K	21
00G3SEI20V	117	1510 PH	106	1536 BZ-8W27K	17	1551 BZ	65	15702 MZ	26
00T3-27LED	115	15102 MR-LL	43	1536 BZ-8W3K	17	1551 SW	65	15705 BZ	26
00T3-27LED-1.5	115	15102 TK-LL	43	1536 BZ-LL	22	1552 SZ-LL	53	15705 BZ-12W27K	19
00T3-LED	115	1511 BZ	30	1536 MZ	22	1553 BZ	64	15705 BZ-12W3K	19
00T5-27LED	115	1512 BZ	30	1536 MZ-12W27K	16	1553 SW	64	15705 BZ-3W27K	19
00T5-27LED-1.5	115	1513 MB-LL	52	1536 MZ-12W3K	16	1554 SZ-LL	54	15705 BZ-3W3K	19
00T5-27LED-2.5	115	1513 OZ-LL	52	1536 MZ-3W27K	16	15540 BK	40	15705 BZ-5W27K	19
00T5-LED	115	1516 MR-LL	54	1536 MZ-3W3K	16	15540 BZ	40	15705 BZ-5W3K	19
0100 FT	108	1518 BZ-LL	44	1536 MZ-5W27K	16	1555 CB-LL	52	15705 BZ-8W27K	19
0150 BK	106	1518 CD-LL	44	1536 MZ-5W3K	16	15556 MZ	61	15705 BZ-8W3K	19
0150 SS	106	1518 HE-LL	44	1536 MZ-8W27K	16	1556 BZ	65	15705 MZ	26
0200 LT	106	1518 MZ-LL	44	1536 MZ-8W3K	16	1556 SW	65	15705 MZ-12W27K	21
0250 FT	108	1518 TT-LL	44	1536 SK	22	1557 BZ	64	15705 MZ-12W3K	21
0300 SS	106	1518SK-LL	44	1536 SK-12W27K	17	1557 SW	64	15705 MZ-3W27K	21
0600 SS	106	1521 BZ	24	1536 SK-12W3K	17	1560 AR-LL	51	15705 MZ-3W3K	21
0900 SS	106	15222 BK	57	1536 SK-3W27K	17	15601 BZ	34	15705 MZ-5W27K	21
1001 BK-LV	75	15222 BZ	57	1536 SK-3W3K	17	15601 BZ-LED	34	15705 MZ-5W3K	21
1001 OZ-LV	75	15222 MW	57	1536 SK-5W27K	17	15601 TT	34	15705 MZ-8W27K	21
1001 SI-LV	75	15232 BK	57	1536 SK-5W3K	17	15601 TT-LED	34	15705 MZ-8W3K	21
1007 BK-LV	77	15232 BZ	57	1536 SK-8W27K	17	15602 BZ	34	15708 BZ	26
1007 OZ-LV	77	15232 MW	57	1536 SK-8W3K	17	15602 BZ-LED	34	15708 BZ-12W27K	19
1007 SI-LV	77	15288 BK	90	1536 SK-LL	22	15602 TT	34	15708 BZ-12W3K	19
1161 AH-LV	73	15288 BZ	90	1539 BS	24	15602 TT-LED	34	15708 BZ-3W27K	19
1161 BK-LV	73	15288 TT	90	1540 CB-LL	53	15607 BK	33	15708 BZ-3W3K	19
1167 AH-LV	76	1529 CB-LL	52	1542 BZ	62	15607 BK-LED	33	15708 BZ-5W27K	19
1167 BK-LV	76	1530 BZ	24	1542 BZ-LED	62	15609 BZ	33	15708 BZ-5W3K	19
1187 BLB-LV	78	1531 BZ	48	15444 BZ	59	15609 BZ-LED	33	15708 BZ-8W27K	19
1187 SN-LV	78	1531 TK	48	15444 BZ-10	59	15609 TT	33	15708 BZ-8W3K	19
1304BK	79	1533 BZ	48	15444 ST	59	15609 TT-LED	33	15708 MZ	28
1304BZ	79	1533 TK	48	15444 ST-10	59	1561 AR-LL	51	15708 MZ-12W27K	21
1304HE	79	1534 BZ	49	15444 TT	59	1561 SK-LL	51	15708 MZ-12W3K	21
1321 BK-LV	76	1534 TK	49	15444 TT-10	59	1562 BZ	66	15708 MZ-3W27K	21
1321 KZ-LV	76	1535 BZ	22	15446 BZ	59	1562 SW	66	15708 MZ-3W3K	21
13w27k24-PAR36	112	1535 BZ-12W27K	17	15446 BZ-10	59	1563 BZ	66	15708 MZ-5W27K	21
13w27k60-PAR36	112	1535 BZ-12W3K	17	15446 ST	59	1563 SW	66	15708 MZ-5W3K	21
13w30k24-PAR36	112	1535 BZ-3W27K	17	15446 ST-10	59	1565 BZ	66	15708 MZ-8W27K	21
13w30k60-PAR36	112	1535 BZ-3W3K	17	15446 TT	59	1565 SW	66	15708 MZ-8W3K	21



15714 BZ	40	2121 MB-LV	74	56000 CY	87
1579 MT-LL	50	2221 CB-LV	74	58015 BZ-LL	99
1579 SS-LL	50	2227 CB-LV	74	58025 BZ	99
1583 NC	24	2327 OZ-LV	77	58504 BZ	93
1594 BZ-LL	63	2361 MB-LV	73	58504 BZ3K	95
1594 MZ-LL	63	2361 OZ-LV	73	58504 MZ	93
1598 BK	29	2561 MB-LV	73	58504 SK	93
1598 BK	113	2561 OZ-LV	73	58504 SK3K	95
1598 MZ-FT	29	2567 MB-LV	80	58504 SW	93
1598 MZ-FT	113	2567 OZ-LV	80	58504 SW3K	95
1598 MZ-RG	29	2569 MB-LV	80	58504 TT	93
1598 MZ-RG	113	2569 OZ-LV	80	58506 BZ	97
16004 MZ-LL	46	2576 AR-LV	77	58506 BZ3K	95
16007 MZ-LL	46	2576 SK-LV	77	58506 SK	97
1601 MB-LV	75	2687 BK-LV	74	58506 SK3K	95
1601 OZ-LV	75	2687 DZ-LV	74	58506 SW	97
16010 MZ-LL	46	2689 BK-LV	81	58506 SW3K	95
16012 MZ-LL	47	2689 DZ-LV	81	58506 TT	97
16016 BK-LL	37	27G3SE	117	58508 BZ	96
16016 MZ-LL	47	27G3SE120V-75	117	58508 BZ3K	95
16016 OZ-LL	37	2801 DZ-LV	75	58508 MZ	96
16019 BK-LL	37	2801 OZ-LV	75	58508 SK	96
16019 MZ-LL	47	2917 DZ-LV	78	58508 SK3K	95
16019 OZ-LL	37	2917 OZ-LV	78	58508 SW	96
16022 BK-LL	37	29206 DZ-LV	84	58508 SW3K	95
16022 MZ-LL	47	29206 SQ-LV	84	58508 TT	96
16022 OZ-LL	37	29208 DZ-LV	84	59024 BZ-LL	99
16050 MZ-LL	46	29208 SQ-LV	84	59040 BZ	99
16055 MZ-LL	46	29304 BGR-LV	82	6638 BK	79
16501 MZ	23	29304 WB-LV	82	6660 OI	79
16501 MZ-27K60	23	29504 BGR-LV	82	6660 TK	79
16507 MZ	23	29505 BGR-LV	82	6660 TR	79
16507 MZ-27K60	23	29703 VI-LV	81	6662 TK	79
16571 MZ-LL	23	29705 VI-LV	81	6808 BK	79
16701 MZ	28	4w27k15	114	6W27K15	114
16704 MZ	28	4w27k45	114	6W27K24-PAR36	112
16707 MZ	28	4w27k60	114	6W27K45	114
1671 BK-LV	73	4W3k15	114	6W27K60-PAR36	112
16710 MZ	28	4W3K45	114	6W30K24-PAR36	112
1677 BK-LV	73	4W3k60	114	6W30K60-PAR36	112
16801 MZ-LL	62	50200 WN	102	6W3K15	114
16804 MZ-LL	62	50200 WN	108	6W3K45	114
16805 MZ-LED	62	50500 PP	102	E12LED12V	116
16807 MZ	108	51000 BZ	100	E26LED12V	116
16814 BZ	109	54000 BK	89	EA-LMW-1.5W	116
16814 MZ	109	54000 BZ	89	EA-LMW-2.5W	116
16910 MZ	108	55000 BZ	89	MR1127K	115
16918 MZ	108	55601 BZ	91	MR1127K-3W	115
16990 MZ	108	55601 TT	91	MR827K	115
1857 DZ-LV	76	55602 BZ	91		
1857 LZ-LV	76	55602 TT	91		
1861 OZ-LV	74	55607 BK	90		
1861 TK-LV	74	55702 BZ27K	101		
1901 MT-LV	76	55702 BZ3K	101		
1901 SS-LV	76	55702 MZ27K	101		
20017 BK-LV	78	55702 MZ3K	101		
2047 GS-LV	77	56000 BK	87		
2047 SN-LV	77	56000 BZ	87		

# We want you to enjoy your experience with Hinkley.

---

We're proud to be a 4th generation family company, and we love what we do. We've been designing and creating products with the same level of style and quality we put in our own homes since 1922. So whether you are flipping through our catalog, surfing our site, getting inspired through social media, chatting with a member of our team or checking out our designs with one of our retailers, we're always looking for your experience with Hinkley to be a positive one. Here's all you need to know:

## CATALOG COLLECTIONS

Hinkley catalogs feature our current and complete product line along with important product specs and detailed photography. A must for the print-loving researcher who likes to tab their favorites. Stop by your local showroom for your own copy.

## HINKLEY.COM

Dive in! Our easy-to-use site makes your product research process a snap, with the added benefit of tips, trends, installation guidelines and a quick connection to our retail partners.

## #HINKLESTYLE

We love seeing how you live and sharing ideas and inspiration with each other. Stay in the loop on all Hinkley happenings, from your favorites styles, the best (seriously) giveaways, helpful tips, our latest collabs, Team Hinkley shenanigans, and brand new design drops. @hinkleylighting



## TEAM HINKLEY

Want to chat? Contact us at [customer care@hinkley.com](mailto:customer care@hinkley.com) or 1.800.HINKLEY.

Hinkley stands behind the quality of our lighting fixtures and ceiling fans with product warranties that are among the strongest in the industry. For details of warranty coverage on specific products, please refer to [hinkley.com](http://hinkley.com) or consult a qualified Hinkley retail distributor.

Several Hinkley products are protected under U.S. Patent and foreign patent, or patent pending.

## WELCOME TO THE FAMILY

We stand by every fixture we make but we know that sometimes things happen. Simply register your fixture so we can answer any questions as quickly as possible. Just head over to [hinkley.com/register](http://hinkley.com/register). We're always here if you have a question, need some help, or want to chat about our products.

©2021 Hinkley, Inc. All rights reserved in all copyrightable works.



Hinkley is a proud partner of the American Lighting Association.

---

# HINKLEY

HINKLEY.COM

## GLOBAL HEADQUARTERS

33000 Pin Oak Parkway | Avon Lake, Ohio 44012  
T 440 653 5500 | F 440 653 5555 | [hinkley.com](http://hinkley.com)

## SHOWROOM

Dallas Trade Mart 3210 | Dallas, Texas 75207



Connect with us | [#hinkleystyle](https://www.instagram.com/hinkleystyle)

LANDSCAPE  
CATALOG : 2021 LSCAT421

