

 GHIDINI LUCITALIA
HOME LIGHTING



 GHIDINI LUCITALIA
HOME LIGHTING

PROFILO AZIENDALE

COMPANY PROFILE



Ghidini & Lucitalia Lighting nasce dalla unione tra due aziende storiche del settore dell'illuminazione.

Ghidini Lighting nasce nel 1974 ed è una azienda Italiana specializzata nella progettazione e produzione di apparecchi tecnici per l'illuminazione per esterni. Nel corso della sua storia Ghidini Lighting ha focalizzato la propria ricerca nello sviluppo di una vasta gamma di prodotti che soddisfano le più alte aspettative di progettisti, contribuendo a valorizzare gli ambienti residenziali o commerciali attraverso un design che si integra armoniosamente nei più svariati contesti progettuali. I prodotti sono costruiti utilizzando materiali e componenti di altissimo livello che garantiscono affidabilità ed efficienza nel corso del tempo.

Lucitalia Milano nasce nel 1966 come "LUCI illuminazione d'interni" e si afferma in breve tempo come una delle Aziende produttrici più originali e innovative nel prodotto di design moderno. La notorietà di LUCI si eleva a livello internazionale con la creazione nel 1983 della lampada da tavolo Kandido creata in collaborazione con Ferdinand Alexander Porsche. Nel corso del tempo la collaborazione di LUCI con designers di prestigio internazionale è andata sempre crescendo ed oggi include nella propria storia nomi come: Gianfranco Frattini, Adonis, Caltha, Ignazio; Toshiyuki Kita, Rodolfo Bonetto Rio, Flu, Todo; Giugiaro Design, Asahara Sigeaki, Francesco Brivio, Carlo Fassina e Giancarlo Forcolini, Serge & Robert Cornelissen, Gabi Peretto; Lucitalia si è specializzata sempre più in ambito tecnico decorativo sia in ambito residenziale che commerciale valorizzando al meglio gli ambienti attraverso un proprio stile distintivo.

L'unione delle due aziende consente ai progettisti di poter utilizzare un unico interlocutore nello sviluppo dei propri progetti sia in ambienti esterni che d'interni.

Ghidini & Lucitalia Lighting was born from the union of 2 historical lighting companies.

Ghidini Lighting, founded in 1974, is an Italian company specialized in the design and production of technical outdoor lighting fixtures. Since its foundation, Ghidini Lighting has focussed its research and development on a vast range of products which satisfy the wants and needs of specifiers, seamlessly integrating into an endless array of residential and commercial spaces. Products are manufactured using only the highest quality materials and components which guarantee efficiency and performance over time.

Lucitalia Milano was founded in 1966 under the name "LUCI illuminazione d'interni" and quickly established itself as one of the most innovative and original designers and manufacturers of modern design lighting fixtures. The creation in 1983 of the now iconic Kandido table lamp, in collaboration with Ferdinand Alexander Porsche, thrust LUCI into the International spot light. Collaboration with other world famous designers quickly followed and increased over time to include: Gianfranco Frattini, Adonis, Caltha, Ignazio; Toshiyuki Kita, Rodolfo Bonetto Rio, Flu, Todo; Giugiaro Design, Asahara Sigeaki, Francesco Brivio, Carlo Fassina e Giancarlo Forcolini, Serge & Robert Cornelissen, Gabi Peretto. Lucitalia has increasingly specialized in technical decorative lighting suited for both residential and commercial applications offering technical performance and distinctive design.

The two companies offers lighting professionals one source when specifying projects for both interior and exterior spaces.

LETTURE DEL CODICE

READING THE CODE

LETTURA CODICE PRODOTTO OUTDOOR HOW TO COMPOSE THE OUTDOOR CODE

5329 . BRM . T . 15

CODICE MODELLO
MODEL CODE

COLORE
COLOR

A richiesta sono disponibili
LED con temperature di colore diverse
2700K
3000K
4000K

*Upon request are available
LED with different colours temperatures*

2700K

3000K

4000K

LETTURA CODICE PRODOTTO INDOOR HOW TO COMPOSE THE INDOOR CODE

21201 . 01 . 31 - blue

CODICE MODELLO
MODEL CODE

COLORE
COLOR

TEMPERATURA
COLOR

COLORE CAVO
(ACCESSORIO)
COLORED CABLE
(ACCESSORY)







COLOR
TEMPERATURE

Le quote dei prodotti di questo catalogo
sono espresse in millimetri

*All units in this catalogue are mean in
millimeters*

LEGENDA ICONE

ICONE GUIDE

	Calpestabile <i>Walk over</i>
	Carrabile <i>Drive over</i>
	Marchio CE <i>CE brand</i>
	Grado di protezione <i>IP rating</i>
	Classe di isolamento I <i>Classification I</i>
	Classe di isolamento II <i>Classification II</i>
	Classe di isolamento III <i>Classification III</i>

INDICE PRODOTTI PER ESTERNI

OUTDOOR PRODUCTS INDEX

Luce a pavimento incassata

Recessed in ground light



Microsegno RD
19



Segno RD
19



Maxisegno RD
19

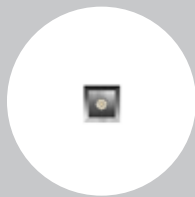

Microsegno SQ
21

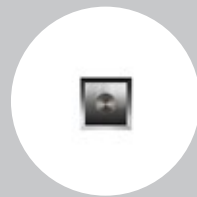

Segno SQ
21

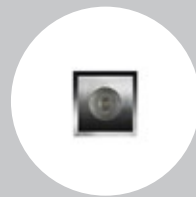

Maxisegno SQ
21



Microsegno flat RD
17



Segno flat RD
17



Maxisegno flat RD
17



Microsegno flat SQ
20

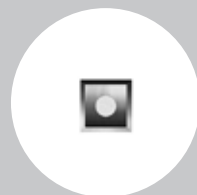

Segno flat SQ
20

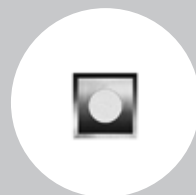

Maxisegno flat SQ
20



Minispiacar RD
23



Minispiacar SQ
23



Spiacar RD
25



Spiacar SQ
25



Microsegno walk
27



Microsegno walk
27

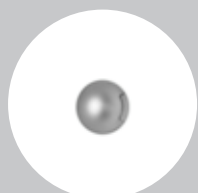

Segno walk
28

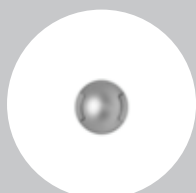

Segno walk
28



Segno walk
28

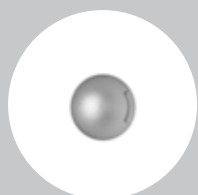

Maxisegno walk
29

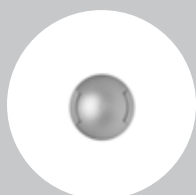

Maxisegno walk
29



Maxisegno walk
29

INDICE PRODOTTI PER ESTERNI

OUTDOOR PRODUCTS INDEX

Luce a parete

Wall light



Microspia flat
31

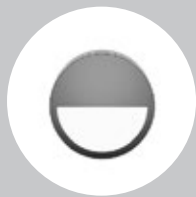

Midispia flat
31



Spia flat
31



Microspia flat
33



Midispia flat
33

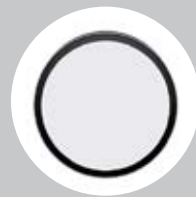

Spia flat
33

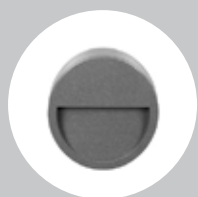

Miniverso flat RD
35



Miniverso flat SQ
35

Luce a parete incassata

Recessed wall light

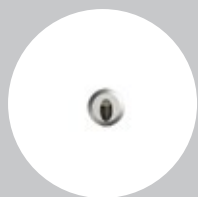

Microsegno AS RD
37



Segno AS RD
37

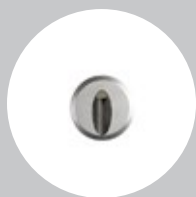

Maxisegno AS RD
37

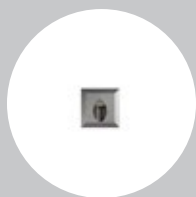

Microsegno AS SQ
39

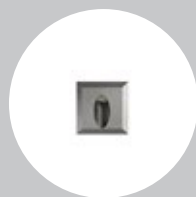

Segno AS SQ
39

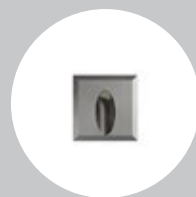

Maxisegno AS SQ
39

Proiettori

Spotlight



Microsegno spot RD
43



Segno spot RD
43



Maxisegno spot RD
43

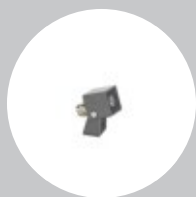

Microsegno spot SQ
45

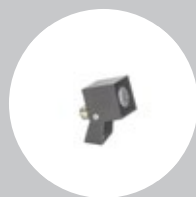

Segno spot SQ
45



Maxisegno spot SQ
45



Minipario
47

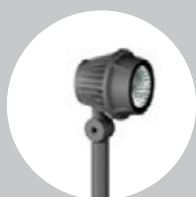

Minipario
47

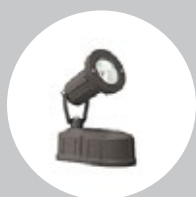

Micromikko
49

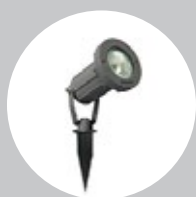

Micromikko
49

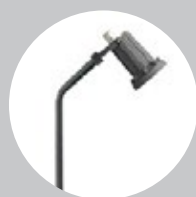

Micromikko
49

INDICE PRODOTTI PER ESTERNI

OUTDOOR PRODUCTS INDEX

Proiettori

Spotlight



Microfaro flat
51



Minifaro flat
51



Microfaro
53



Minifaro
53

Luce a parete

Wall light



Compatto
55



Compatto
55



Minimodo
57



Minimodo
57



Microbivio
59



Minibivio
60



Microtorre
63



Minitorre
65



Tratto wall
67



Viso
69

Luce a soffitto

Ceiling light

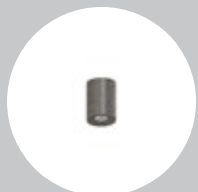

Micropunto RD
71



Punto RD
71



Maxipunto RD
71



Micropunto SQ
73



Punto SQ
73



Maxipunto SQ
73

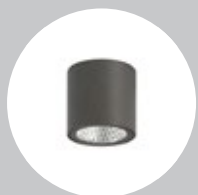

Nanotorre RD
75

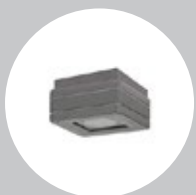

Microtorre flat SQ
soffitto
77



Minitorre flat soffitto
SQ
77



Microtorre soffitto
SQ
79



Minitorre soffitto SQ
79

INDICE PRODOTTI PER ESTERNI

OUTDOOR PRODUCTS INDEX

Bollard

Bollard



Minizac! 300
81



Minizac! 500
81



Minizac! 800
81



Zac! 600
83



Zac! 900
83

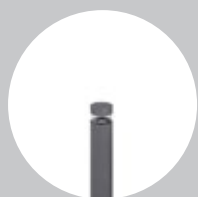

Minitondo 300
88/89



Minitondo 500
88/89



Minitondo 800
88/89

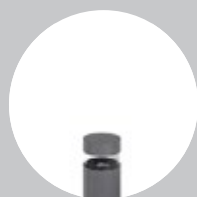

Tondo 175
91/93



Tondo 600
91/93



Tondo 900
91/93



Miniquadro 300
95/97



Miniquadro 500
95/97



Miniquadro 800
95/97

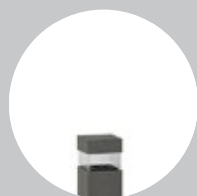

Quadro 175
98/99



Quadro 600
98/99



Quadro 900
98/99

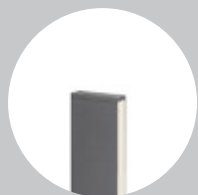

Rettangolo 300
101

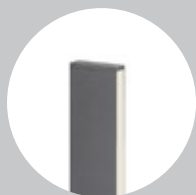

Rettangolo 500
101

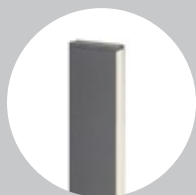

Rettangolo 800
101



Compatto bollard 500
103



Compatto bollard 800
103



Polverti flat 300
105



Polverti flat 500
105



Microbivio bollard
107



Minibivio bollard
107

INDICE PRODOTTI PER INTERNI

INDOOR PRODUCTS INDEX

Luce a parete

Wall lights



Zero 0
111



Zero 1
113



Zero verti
117



Zero kid
15



Adam W
119



Cufflink
121



Cage 1
123

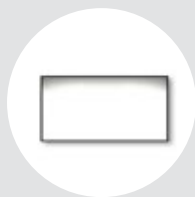

Cage 2
123



Cage 3
123



Zero amica R
125

Luce a soffitto

Ceiling lights



Stelo 0C
133



Stelo 1C
133



Drum 0C
135



Drum 2C
135



Box 0C RD
129



Box 1C RD
131



Box 0C SQ
129



Box 1C SQ
131



Box 1C SQ 2L
131

Luce a soffitto incassata

Recessed ceiling lights

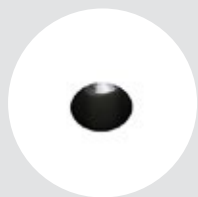

Comfort RD RT
137

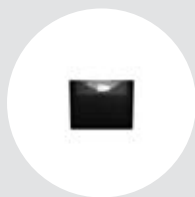

Comfort SQ RT
137

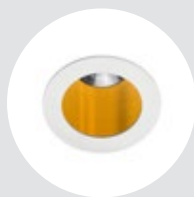

Comfort RD RF
137



Comfort SQ RF
137

INDICE PRODOTTI PER INTERNI

INDOOR PRODUCTS INDEX

Luce a sospensione

Suspension lights



Bell 1S
139



Bell 1S
139

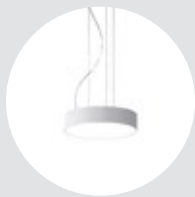

Drum 0S
141



Drum 2S
141



Stelo 0S
143

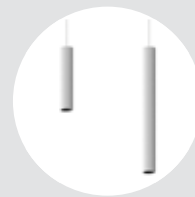

Stelo 1S
143

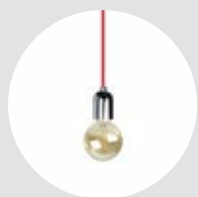

Minima
145



Pragma S
147

Luce da tavolo e pavimento

Table and floor lights

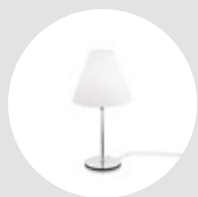

Pragma T
157



Pragma F
153



Taxi F
155

Proiettori e sistemi per binario

Track spotlights & Systems



Point Evo 0A
149



Point Evo 1A
149

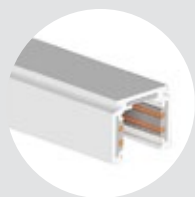

Binario 48V
151

Lineari a parete e incassati

Linear surface and recessed lights

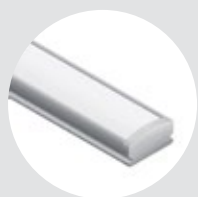

Linear 0W flat
159



Linear 0W 45°
159



Linear 0R flat
159



Linear 1W
159

INDICE ALFABETICO PRODOTTI

ALPHABETIC PRODUCTS INDEX

A			
ADAM W.....	119		
B			
BELL.....	139		
BINARIO MAGNETICO 48V.....	151		
BOX 0C.....	129		
BOX 1C.....	131		
C			
CAGE.....	123		
COMFORT.....	137		
COMPATTO.....	55		
COMPATTO BOLLARD.....	103		
CUFFLINK.....	121		
D			
DRUM 0C.....	135		
DRUM 0S.....	141		
DRUM 1C.....	135		
DRUM 1S.....	141		
L			
LINEAR.....	159		
M			
MAXIPUNTO RD.....	71		
MAXIPUNTO SQ.....	73		
MAXISEGNO AS RD.....	35		
MAXISEGNO AS SQ.....	37		
MAXISEGNO FLAT RD.....	17		
MAXISEGNORD.....	19		
MAXISEGNO SPOT INOX RD.....	41		
MAXISEGNO SPOT RD.....	43		
MAXISEGNO SPOT SQ.....	45		
MAXISEGNO SQ.....	20		
MAXISEGNO WALK.....	29		
MICROBIVIO.....	59		
MICROBIVIO FLOOR.....	107		
MICROFARO.....	53		
MICROFARO FLAT.....	51		
MICROMIKKO.....	49		
MICROPUNTO RD.....	71		
MICROPUNTO SQ.....	73		
MICROSEGNO AS RD.....	35		
MICROSEGNO AS SQ.....	37		
MICROSEGNO RD.....	19		
MICROSEGNO SPOT INOX RD.....	41		
MICROSEGNO SPOT RD.....	43		
MICROSEGNO SPOT SQ.....	45		
MICROSEGNO SQ.....	20		
MICROSEGNO WALK.....	27		
MICROTORRE.....	63		
MICROTORRE FLAT SOFFITTO.....	77		
MICROTORRE SOFFITTO.....	79		
MINIBIVIO.....	61		
MINIBIVIO FLOOR.....	107		
MINIFARO.....	53		
MINIFARO FLAT.....	35		
MINIMA.....	145		
MINIMODO.....	57		
MINIPARIO.....	47		
MINIQUADRO 180°.....	95		
MINIQUADRO 360°.....	97		
MINISPIACAR.....	23		
MINITONDO 180°.....	88		
MINITONDO 360°.....	89		
MINITONDO INOX 180°.....	85		
MINITONDO INOX 360°.....	87		
MINITORRE.....	65		
MINITORRE FLAT SOFFITTO.....	77		
MINITORRE SOFFITTO.....	79		
MINIVERSO FLAT RD.....	39		
MINIVERSO FLAT SQ.....	39		
MINIZAC!.....	81		
N			
NANOTORRE SOFFITTO.....	75		
P			
POINT EVO.....	149		
POLVERTI FLAT.....	105		
PRAGMA F.....	153		
PRAGMA S.....	147		
PRAGMA T.....	157		
PUNTO RD.....	71		
PUNTO SQ.....	73		
Q			
QUADRO 180°.....	98		
QUADRO 360°.....	99		
R			
RETTANGOLO.....	101		
S			
SEGNO AS RD.....	37		
SEGNO AS SQ.....	39		
SEGNO FLAT RD.....	17		
SEGNO RD.....	19		
SEGNO SPOT INOX RD.....	41		
SEGNO SPOT RD.....	43		
SEGNO SPOT SQ.....	45		
SEGNO SQ.....	20		
SEGNO WALK.....	28		
SPIA FLAT.....	31		
SPIACAR.....	25		
STELO 0C.....	133		
STELO 0S.....	143		
STELO 1C.....	133		
STELO 1S.....	143		
T			
TAXI F.....	155		
TONDO 180°.....	91		
TONDO 360°.....	93		
TRATTO WALL.....	67		
V			
VISO.....	69		
Z			
ZAC!.....	83		
ZERO 0.....	111		
ZERO 1.....	113		
ZERO 1 VERTI.....	117		
ZERO AMICA.....	125		
ZERO AMICA R GLASS.....	127		
ZERO KID.....	115		

INDICE CODICE PRODOTTI

PRODUCTS CODE INDEX

01210.--.....	147	1159.BGX.T.--.....	61	1372.LVX.T.--.....	93	1447.BRX.T.--.....	88	21406.--.31.....	127
01211.--.....	147	1160.AHX.T.--.....	61	1375.BRX.T.--.....	93	1447.BRX.T.15.....	85	23102.--.31.....	133
01212.--.....	157	1163.BAX.T.--.....	61	1375.CGX.T.--.....	93	1447.LVX.T.--.....	88	23104.--.31.....	133
01213.--.....	153	1170.BAM.T.15.....	41	1375.LVX.T.--.....	93	1447.LVX.T.15.....	85	23111.--.31.....	133
01214.--.....	153	1170.BAS.T.15.....	41	1377.I6X.T.15.....	27	1448.BRX.T.--.....	88	23112.--.31.....	133
02315.--.....	157	1171.BDM.T.15.....	41	1378.I6X.T.15.....	27	1448.BRX.T.15.....	85	23141.--.31.....	143
03600.--.....	153	1171.BDS.T.15.....	41	1379.BAX.T.15.....	28	1448.LVX.T.--.....	88	23143.--.31.....	143
03630.--.....	153	1172.BGM.T.15.....	41	1380.BAX.T.15.....	28	1448.LVX.T.15.....	85	23151.--.31.....	143
1007.BAM.T.15.....	19	1172.BGS.T.15.....	41	1381.BAX.T.15.....	28	1449.BRX.T.--.....	88	23153.--.31.....	143
1007.BAS.T.15.....	19	1196.AHF.T.--.....	107	1382.ZEX.T.15.....	29	1449.BRX.T.15.....	85	23680.--.....	151
1008.BDM.T.15.....	19	1197.DDF.T.--.....	107	1383.ZEX.T.15.....	29	1449.LVX.T.--.....	88	23681.--.....	151
1008.BDS.T.15.....	19	1198.BRF.T.--.....	107	1384.ZEX.T.15.....	29	1449.LVX.T.15.....	85	23682.--.....	151
1009.AHF.T.15.....	19	1199.ERF.T.--.....	107	1385.CAX.O.--.....	33	1450.BRX.T.--.....	98	23684.--.....	151
1009.AHM.T.15.....	19	1208.AHF.T.--.....	77	1386.EEX.O.--.....	33	1450.CGX.T.--.....	98	23685.--.....	151
1009.BGM.T.15.....	19	1209.GZFT.--.....	77	1387.HEX.O.--.....	33	1450.LVX.T.--.....	98	23686.--.....	151
1009.BGS.T.15.....	19	1220.LVF.T.--.....	75	1388.CAX.O.--.....	31	1451.BRX.T.--.....	98	24301.--.31.....	113
1113.BAM.T.--.....	43	1224.I6F.B.15.....	20	1389.EEX.O.--.....	31	1451.CGX.T.--.....	98	24304.--.31.P.....	113
1113.BAS.T.--.....	43	1225.I6F.B.15.....	20	1390.HEX.O.--.....	31	1451.LVX.T.--.....	98	24501.--.31.....	117
1114.BDM.T.--.....	43	1226.I6F.B.15.....	20	1392.FKX.T.--.....	35	1456.BRX.T.--.....	91	24503.--.31.....	117
1114.BDS.T.--.....	43	1227.BAM.T.15.....	21	1396.AHF.T.--.....	51	1456.LVX.T.--.....	91	25001.--.31.....	137
1115.AHF.T.--.....	43	1227.BAS.T.15.....	21	1397.GZFT.--.....	51	1457.BRX.T.--.....	93	25002.--.31.....	137
1115.AHM.T.--.....	43	1228.BDM.T.15.....	21	1397.GZS.T.--.....	51	1457.LVX.T.--.....	93	25005.--.31.....	137
1115.BGM.T.--.....	43	1228.BDS.T.15.....	21	1415.BRX.T.--.....	89	1459.BRX.T.--.....	98	25006.--.31.....	137
1115.BGS.T.--.....	43	1229.AHF.T.15.....	21	1415.BRX.T.15.....	87	1459.LVX.T.--.....	98	25140.--.31.T.....	129
1117.I6F.B.15.....	17	1229.AHM.T.15.....	21	1415.LVX.T.--.....	89	1460.BRX.T.--.....	99	25150.--.31.T.....	129
1118.I6F.B.15.....	17	1229.BGM.T.15.....	21	1415.LVX.T.15.....	87	1460.LVX.T.--.....	99	25201.--.31.....	123
1119.I6F.B.15.....	17	1229.BGS.T.15.....	21	1416.BRX.T.--.....	89	1533.FKX.O.--.....	67	25202.--.31.....	123
1126.BAM.T.--.....	45	1244.AHX.B.15.....	23	1416.BRX.T.15.....	87	1534.P1X.O.--.....	67	25203.--.31.....	123
1126.BAS.T.--.....	45	1245.AHX.B.15.....	23	1416.LVX.T.--.....	89	1536.GLX.O.--.....	67	25301.--.31.....	121
1127.BDM.T.--.....	45	1250.AHX.A.--.....	81	1416.LVX.T.15.....	87	1537.LRX.O.--.....	67	26501.--.31.....	155
1127.BDS.T.--.....	45	1250.BRX.A.--.....	81	1417.BRX.T.--.....	89	1958.DGFT.--.....	65	26701.--.31.....	135
1128.AHF.T.--.....	45	1251.AHX.A.--.....	81	1417.BX.T.15.....	87	1959.GNFT.--.....	65	26702.--.31.....	135
1128.AHM.T.--.....	45	1251.BRX.A.--.....	81	1417.LVX.T.--.....	89	1960.AHF.T.--.....	63	26710.--.31.....	135
1128.BGM.T.--.....	45	1252.AHX.A.--.....	81	1417.LVX.T.15.....	87	1960.BRF.T.--.....	63	26711.--.31.....	135
1128.BGS.T.--.....	45	1252.BRX.A.--.....	81	1421.ETX.O.--.....	101	1961.ERF.T.--.....	63	26715.--.31.....	141
1129.BRF.T.--.....	47	1253.AHX.A.--.....	83	1422.AHX.O.--.....	101	1962.AHF.T.--.....	79	26716.--.31.....	141
1129.BRM.T.--.....	47	1253.BRX.A.--.....	83	1423.CAX.O.--.....	101	1963.DGFT.--.....	79	26725.--.31.....	141
1129.BRS.T.--.....	47	1254.AHX.A.--.....	83	1426.CAF.T.--.....	103	1963.DGFT.--.....	79	26726.--.31.....	141
1132.AHF.T.--.....	53	1254.BRX.A.--.....	83	1427.CAF.T.--.....	103	20202.--.31.....	115	26801.--.31.....	149
1133.DGFT.--.....	53	1256.BRX.T.--.....	95	1430.BAM.T.--.....	71	20220.--.31.T.....	111	26802.--.31.....	149
1133.DGS.T.--.....	53	1257.BRX.T.--.....	95	1431.BDM.T.--.....	71	20365.--.31.T.....	119	26815.--.31.....	149
1133.FNFT.--.....	53	1258.BRX.T.--.....	95	1432.AHF.T.--.....	71	20367.--.31.T.....	119	26816.--.31.....	149
1133.FNST.--.....	53	1259.BRX.T.--.....	97	1432.BGM.T.--.....	71	20801.--.31.....	159	26901.--.....	145
1136.ETX.T.--.....	35	1260.BRX.T.--.....	97	1433.BAM.T.--.....	73	20802.--.31.....	159	26902.--.....	145
1139.ETX.T.--.....	105	1261.BRX.T.--.....	97	1434.BDM.T.--.....	73	20803.--.31.....	159	27001.--.31.....	139
1143.AHF.T.--.....	55	1314.36F.S.T.--.....	69	1435.AHF.T.--.....	73	20820.--.31.....	159	27101.--.31.....	139
1143.CAF.T.--.....	55	1314.BRX.S.--.....	69	1435.BGM.T.--.....	73	20821.--.31.....	159	5323.147.A.15.....	25
1144.BRF.T.--.....	55	1330.BGX.B.--.....	57	1436.BAX.O.15.....	37	20822.--.31.....	159	5323.BRM.T.15.....	25
1144.L3S.T.--.....	55	1333.LVX.B.--.....	57	1437.BAX.O.15.....	37	20829.--.31.....	159	5323.BUM.T.15.....	25
1147.BRF.T.--.....	47	1363.S8X.T.--.....	57	1438.BAX.O.15.....	37	20830.--.31.....	159	5329.147.A.15.....	25
1147.BRM.T.--.....	47	1364.S8X.T.--.....	57	1439.BAX.O.15.....	39	20831.--.31.....	159	5329.BRM.T.15.....	25
1147.BRS.T.--.....	47	1369.BRX.T.--.....	99	1440.BAX.O.15.....	39	20832.--.31.....	159	5329.BUM.T.15.....	25
1149.ETX.T.--.....	105	1369.CGX.T.--.....	99	1441.BAX.O.15.....	39	20833.--.31.....	159	5966.CAM.T.--.....	49
1152.AHF.T.--.....	59	1369.LVX.T.--.....	99	1445.BRX.T.--.....	91	20834.--.31.....	159	5966.CAS.T.--.....	49
1152.BGF.T.--.....	59	1370.BRX.T.--.....	99	1445.CGX.T.--.....	91	20901.--.31.....	131	5974.CAM.T.--.....	49
1153.DDF.T.--.....	59	1370.CGX.T.--.....	99	1445.LVX.T.--.....	91	20902.--.31.....	131	5974.CAS.T.--.....	49
1154.AHF.T.--.....	60	1370.LVX.T.--.....	99	1446.BRX.T.--.....	91	20950.--.31.....	131	5984.CAM.T.--.....	49
1154.BRF.T.--.....	60	1372.BRX.T.--.....	93	1446.CGX.T.--.....	91	21401.--.31.....	125	5984.CAS.T.--.....	49
1155.ERFT.--.....	60	1372.CGX.T.--.....	93	1446.LVX.T.--.....	91	21402.--.31.....	125		

I NOSTRI DESIGNER

OUR DESIGNERS



Antonio Maertiniello



Asahara Sigeaki



Ferdinand Alexander Porsche



Francesco Brivio



Gabi Peretto



Giancarlo Fassina



Carlo Forcolini



Hikaru Mori



Serge & Robert Cornelissen



Gianfranco Frattini



Giorgetto Giugiaro



Toshiyuki Kita



Rodolfo Bonetto

FINITURE LUCITALIA

LUCITALIA FINISHES

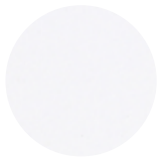

.01 Bianco
White



.19 Grigio
Silver Grey



.22 Nero
Black Matt



.45 Ruggine
Rust



.40 Acciaio
Stainless steel



.39 Nickel
Nickel matt



.56 Oro spazzolato
Brushed gold

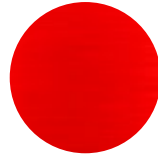

.69 Rosso
Red

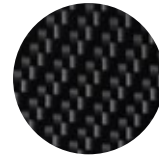

.51 Effetto fibra di carbonio
Carbon fiber effect

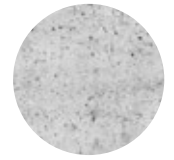

.43 Effetto cemento
Concrete effect



.32 Effetto noce
Walnut effect



.33 Effetto wengè
Wenghè effect

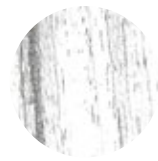

.30 Effetto rovere sbiancato
Whitened Oak effect

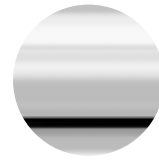

.50 Cromo lucido
Polished chrome



.27 Nero oro
Black gold



.25 Bianco oro
White gold



.71 Bianco rosso
White red

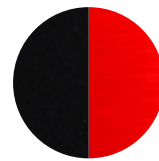

.72 Nero rosso
Black red

FINITURE GHIDINI

GHIDINI FINISHES



.01 Bianco
White



.13 Grigio chiaro
Light grey



.05 Grigio antracite
Anthracite grey



.02 Nero
Black Matt



.45 Ruggine
Rust



.15 Acciaio
Stainless steel



.32 Effetto noce
Walnut effect

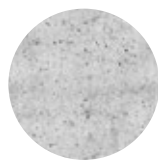

.43 Effetto cemento
Concrete effect

**OUTDOOR
HOME LIGHTING**

 **GHIDINI**

SEGNO FLAT RD

Apparecchio da incasso a pavimento, soffitto e parete. Grazie alle molteplici ottiche e potenze disponibili risulta estremamente versatile nel suo utilizzo. Ideale per illuminare facciate, colonne ed enfatizzare elementi architettonici.

Compact recessed fixture for ground, wall or ceiling application. Thanks to the wide range of optics and powers, it is extremely versatile in its use. It is designed to light passages, walkways, steps and staircases



photo by: Germano Borrelli

SEGNO FLAT RD

Disponibile versione 24V DC
24V DC version available

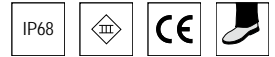

.15 acciaio inox
stainless steel

ACCESSORI ACCESSORIES



controcassa
rough-in housing
201 Microsegno flat
202 Segno flat
203 Maxisegno flat

Controcassa per prodotto
compatibile con alimentatore
Rough-in housing for product
compatible with LED driver

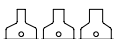

610 Microsegno flat
611 Segno flat
612 Maxisegno flat



620-IP67
Alimentatore 350mA SELV
1 per 1-10 Segno flat 1W
LED driver 350mA SELV
1 for 1-10 Segno flat 1W



204
Connettore rapido IP68
IP 68 fast connector



Adattatore per installazione
su scatola 503
Adaptor for installation like box 503

295 Microsegno flat
296 Segno flat
297 Maxisegno flat

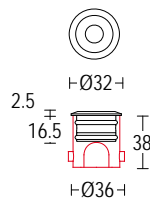

1117.I6F.B.15 1W LED 3000K 120lm
110° ^
max 350mA DC
alimentatore remoto SELV non incluso
remote SELV LED driver not included

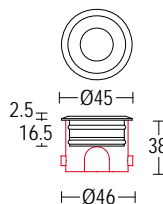

1118.I6F.B.15 1W LED 3000K 120lm
110° ^
max 350mA DC
alimentatore remoto SELV non incluso
remote SELV LED driver not included

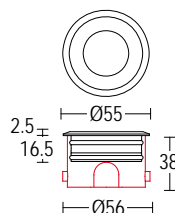

1119.I6F.B.15 1W LED 3000K 120lm
110° ^
max 350mA DC
alimentatore remoto SELV non incluso
remote SELV LED driver not included

SEGNO RD





 **.15** acciaio inox
stainless steel

ACCESSORI ACCESSORIES



controcassa
rough-in housing
197 Microsegno
198 Segno
196 Maxisegno

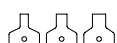

Controcassa per prodotto
compatibile con alimentatore
Rough-in housing for product
compatible with LED driver
610 Microsegno
611 Segno
612 Maxisegno



206-IP67
Alimentatore 500mA SELV
1 per 1-7 Microsegno 1,5W
LED driver 500mA SELV
1 for 1-7 Microsegno 1,5W

624-IP67
Alimentatore 700mA SELV
1 per 1-5 Segno 2W
LED driver 700mA SELV
1 for 1-5 Segno 2W

210-IP67
Alimentatore 1050mA SELV
1 per 1-4 Maxisegno 3W
LED driver 1050mA SELV
1 for 1-4 Maxisegno 3W

620-IP67
Alimentatore 350mA SELV
1 per 1-2 Maxisegno 6W
LED driver 350mA SELV
1 for 1-2 Maxisegno 6W



204
Connettore rapido IP68
IP 68 fast connector

Adattatore per installazione
su scatola 503
Adaptor for installation like box 503



295 Microsegno
296 Segno
297 Maxisegno

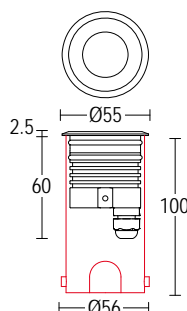
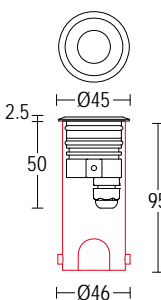
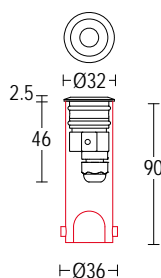

1007.BAS.T.15 1,5W LED 3000K 170lm
16° ^
max 500mA DC
alimentatore remoto SELV non incluso
remote SELV LED driver not included

1007.BAM.T.15 1,5W LED 3000K 170lm
32° ^
max 500mA DC
alimentatore remoto SELV non incluso
remote SELV LED driver not included

1008.BDS.T.15 2W LED 3000K 225lm
13° ^
max 700mA DC
alimentatore remoto SELV non incluso
remote SELV LED driver not included

1008.BDM.T.15 2W LED 3000K 225lm
47° ^
max 700mA DC
alimentatore remoto SELV non incluso
remote SELV LED driver not included

1009.BGS.T.15 3W LED 3000K 315lm
10° ^
max 1050mA DC
alimentatore remoto SELV non incluso
remote SELV LED driver not included

1009.BGM.T.15 3W LED 3000K 315lm
37° ^
max 1050mA DC
alimentatore remoto SELV non incluso
remote SELV LED driver not included

1009.AHM.T.15 6W LED 3000K 845lm
28° ^
max 350mA DC
alimentatore remoto SELV non incluso
remote SELV LED driver not included

1009.AHF.T.15 6W LED 3000K 845lm
62° ^
max 350mA DC
alimentatore remoto SELV non incluso
remote SELV LED driver not included

SEGNO FLAT SQ

Disponibile versione 24V DC
24V DC version available

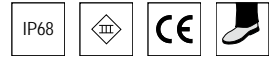

.15 acciaio inox
stainless steel

ACCESSORI ACCESSORIES



controcassa
rough-in housing
201 Microsegno flat
202 Segno flat
203 Maxisegno flat

Controcassa per prodotto
compatibile con alimentatore
Rough-in housing for product
compatible with LED driver

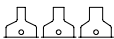

610 Microsegno flat
611 Segno flat
612 Maxisegno flat



620-IP67
Alimentatore 350mA SELV
1 per 1-10 Segno flat 1W
LED driver 350mA SELV
1 for 1-10 Maxisegno 1 W



204
Connettore rapido IP68
IP 68 fast connector



Adattatore per installazione
su scatola 503
Adaptor for installation like box 503

295 Microsegno flat
296 Segno flat
297 Maxisegno flat

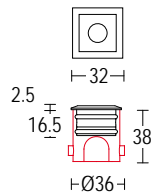

1224.I6F.B.15 1W LED 3000 K 120lm
110° ^
max 350mA DC
alimentatore remoto SELV non incluso
remote SELV LED driver not included

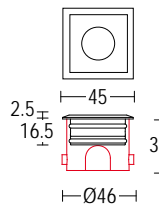

1225.I6F.B.15 1W LED 3000 K 120lm
110° ^
max 350mA DC
alimentatore remoto SELV non incluso
remote SELV LED driver not included

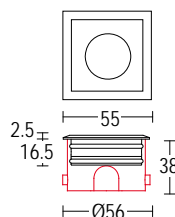

1226.I6F.B.15 1W LED 3000 K 120lm
110° ^
max 350mA DC
alimentatore remoto SELV non incluso
remote SELV LED driver not included



 **.15** acciaio inox
stainless steel

ACCESSORI ACCESSORIES

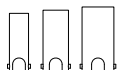

controcassa
rough-in housing
197 Microsegno
198 Segno
196 Maxisegno

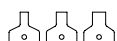

Controcassa per prodotto
compatibile con alimentatore
Rough-in housing for product
compatible with LED driver
610 Microsegno
611 Segno
612 Maxisegno



206-IP67
Alimentatore 500mA SELV
1 per 1-7 Microsegno 1,5W
LED driver 500mA SELV
1 for 1-7 Microsegno 1,5W

624-IP67
Alimentatore 700mA SELV
1 per 1-5 Segno 2W
LED driver 700mA SELV
1 for 1-5 Segno 2W

210-IP67
Alimentatore 1050mA SELV
1 per 1-4 Maxisegno 3W
LED driver 1050mA SELV
1 for 1-4 Maxisegno 3W

620-IP67
Alimentatore 350mA SELV
1 per 1-2 Maxisegno 6W
LED driver 350mA SELV
1 for 1-2 Maxisegno 6W



204
Connettore rapido IP68
IP 68 fast connector

Adattatore per installazione
su scatola 503
Adaptor for installation like box 503



295 Microsegno
296 Segno
297 Maxisegno

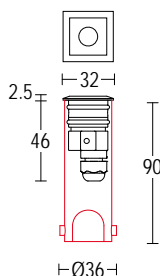

1227.BAS.T.15 1,5W LED 3000 K 170lm
16° ^
max 500mA DC
alimentatore remoto SELV non incluso
remote SELV LED driver not included

1227.BAM.T.15 1,5W LED 3000 K 170lm
32° ^
max 500mA DC
alimentatore remoto SELV non incluso
remote SELV LED driver not included

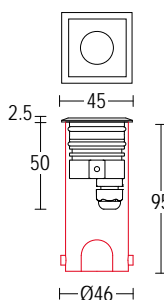

1228.BDS.T.15 2W LED 3000 K 225lm
13° ^
max 700mA DC
alimentatore remoto SELV non incluso
remote SELV LED driver not included

1228.BDM.T.15 2W LED 3000 K 225lm
47° ^
max 700mA DC
alimentatore remoto SELV non incluso
remote SELV LED driver not included

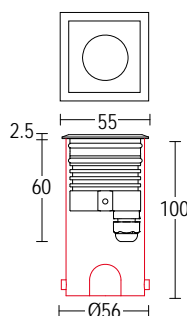

1229.BGS.T.15 3W LED 3000 K 315lm
10° ^
max 1050mA DC
alimentatore remoto SELV non incluso
remote SELV LED driver not included

1229.BGM.T.15 3W LED 3000 K 315lm
37° ^
max 1050mA DC
alimentatore remoto SELV non incluso
remote SELV LED driver not included

1229.AHM.T.15 6W LED 3000 K 845lm
28° ^
max 350mA DC
alimentatore remoto SELV non incluso
remote SELV LED driver not included

1229.AHF.T.15 6W LED 3000 K 845lm
62° ^
max 350mA DC
alimentatore remoto SELV non incluso
remote SELV LED driver not included

MINISPIACAR

Apparecchio da incasso a pavimento. Grazie alle molteplici ottiche e potenze disponibili risulta estremamente versatile nel suo utilizzo. Ideale per illuminare facciate, colonne ed enfatizzare elementi architettonici.

Drive-over in-ground recessed uplight. Thanks to the wide range of optics and powers, it is extremely versatile in its use. It is designed to light facades, columns and emphasizing architectural elements.

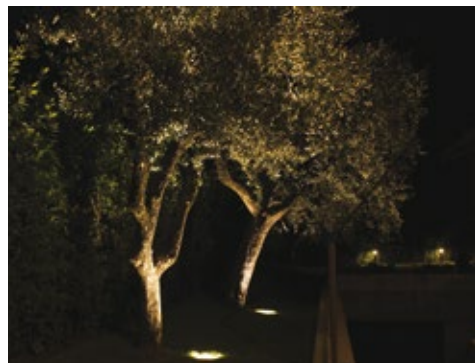

MINISPIACAR

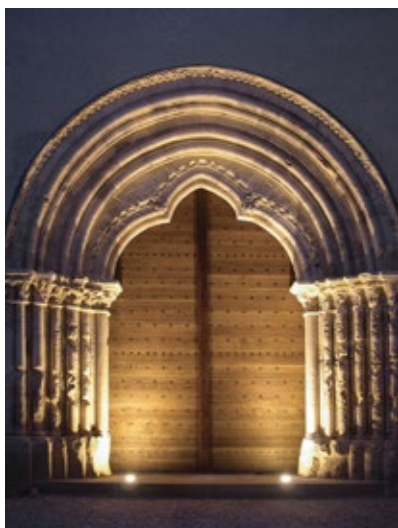

.15 acciaio inox
stainless steel

ACCESSORI ACCESSORIES

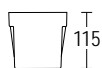

014
controcassa
rough-in housing



273
controcassa senza fondo
rough-in housing bottomless



204
Connettore rapido IP68
IP 68 fast connector

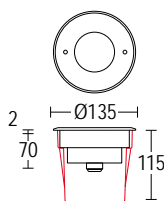

1244.AHX.B.15 7W LED 3000 K 900lm
80° ^
220-240V 50/60hz
alimentatore incluso LED driver integral

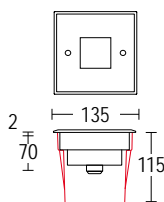

1245.AHX.B.15 7W LED 3000 K 900lm
80° ^
220-240V 50/60hz
alimentatore incluso LED driver integral

SPIACAR



photo by: Germano Borrelli

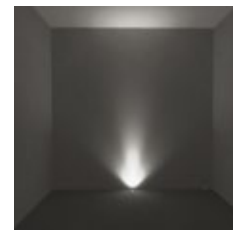
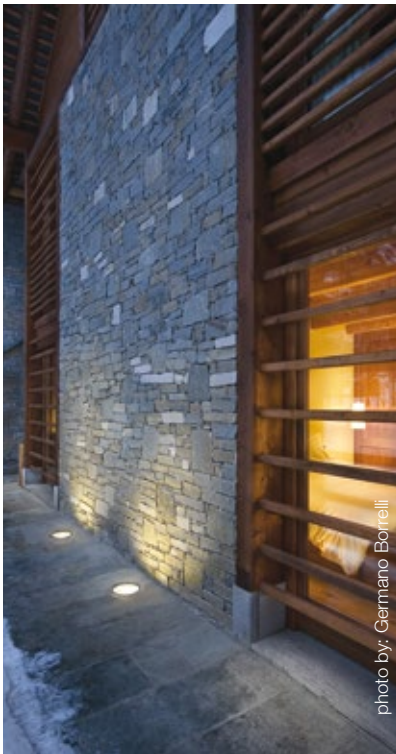

24°



80°

 .15 acciaio inox
stainless steel

ACCESSORI
ACCESSORIES



017
controcassa
rough-in housing



204
Connettore rapido IP68
IP 68 fast connector



279
Connettore per
cablaggio in cascata IP 68
IP 68 connector
for through wiring

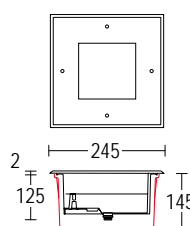
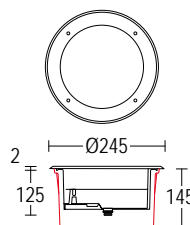

5329.BRM.T.15 12W LED 3000 K 1800lm
24° ^
220-240V 50/60hz
alimentatore incluso *LED driver integral*

5329.BUM.T.15 18W LED 3000 K 2510lm
24° ^
220-240V 50/60hz
alimentatore incluso *LED driver integral*

5329.147.A.15 13W LED 3000 K 2040lm
80° ^
220-240V 50/60hz
alimentatore incluso *LED driver integral*

5323.BRM.T.15 12W LED 3000 K 1800lm
24° ^
220-240V 50/60hz
alimentatore incluso *LED driver integral*

5323.BUM.T.15 18W LED 3000 K 2510lm
24° ^
220-240V 50/60hz
alimentatore incluso *LED driver integral*

5323.147.A.15 13W LED 3000 K 2040lm
80° ^
220-240V 50/60hz
alimentatore incluso *LED driver integral*

SEGNO WALK



Apparecchio ad incasso a pavimento e parete dalle ridottissime dimensioni. Corpo in alluminio anticorrosione 6082 con trattamento di anodizzazione dura, calotta in acciaio inox AISI 316 L, che consente una alta resistenza agli agenti corrosivi. Ideale per l'illuminamento di passaggi, percorsi guidati e camminamenti.

Compact recessed fixture for in-ground or wall application. Body made 6082 anodized aluminium (corrosion resistant), AISI 316L stainless steel dome, which guarantees high resistance to oxidation. The LED lighting source meets energy saving requirements. It is designed to light passages, walkways, steps and staircases.

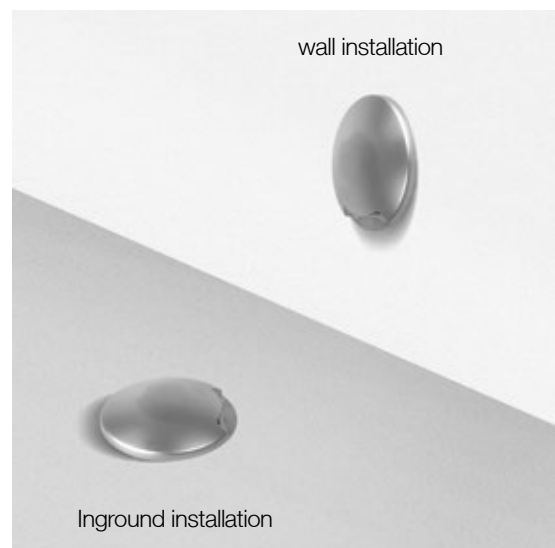



.15 acciaio inox
stainless steel

ACCESSORI ACCESSORIES



201
controcassa
rough-in housing



610
Controcassa per prodotto
compatibile con alimentatore
Rough-in housing for product
compatible with LED driver



620-IP67
Alimentatore 350mA SELV
1 per 1-10 Microsegno 1W
LED driver 350mA SELV
1 for 1-10 Microsegno 1W



204
Connettore rapido IP68
IP 68 fast connector



295
Adattatore per installazione
su scatola 503
Adaptor for installation like box 503

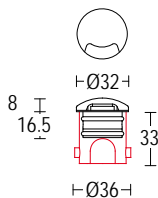

1377.I6X.T.15 1W LED 3000K 135lm
60° ^
max 350mA DC
alimentatore remoto SELV non incluso
remote SELV LED driver not included

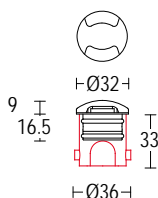

1378.I6X.T.15 1 W LED 3000K 135lm
2 x 60° ^
max 350mA DC
alimentatore remoto SELV non incluso
remote SELV LED driver not included

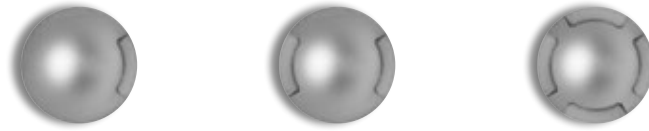

 **.15** acciaio inox
stainless steel

ACCESSORI ACCESSORIES



202
controcassa
rough-in housing



611
Controcassa per prodotto
compatibile con alimentatore
Rough-in housing for product
compatible with LED driver



206-IP67
Alimentatore 500mA SELV
1 per 1-7 Segno 1,5W
LED driver 500mA SELV
1 for 1-7 Segno 1,5W



204
Connettore rapido IP68
IP 68 fast connector



296
Adattatore per installazione
su scatola 503
Adaptor for installation like box 503

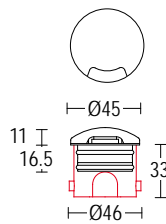

1379.BAX.T.15 1,5W LED 3000K 190lm
60° \wedge
max 500mA DC
alimentatore remoto SELV non incluso
remote SELV LED driver not included

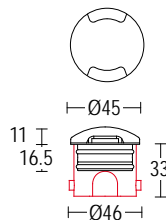

1380.BAX.T.15 1,5W LED 3000K 190lm
2 x 60° \wedge
max 500mA DC
alimentatore remoto SELV non incluso
remote SELV LED driver not included

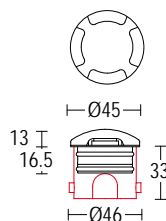

1381.BAX.T.15 1,5W LED 3000K 190lm
4 x 60° \wedge
max 500mA DC
alimentatore remoto SELV non incluso
remote SELV LED driver not included

MAXISEGNO WALK

Disponibile versione 24V DC
24V DC version available

IP68

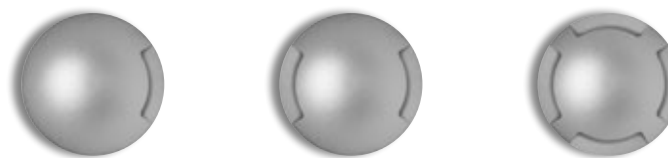

.15 acciaio inox
stainless steel

ACCESSORI ACCESSORIES



200
controcassa
rough-in housing



612
Controcassa per prodotto
compatibile con alimentatore
Rough-in housing for product
compatible with LED driver



624-IP67
Alimentatore 700mA SELV
1 per 1-5 Maxisegno 2W
LED driver 700mA SELV
1 for 1-5 Maxisegno 2W



204
Connettore rapido IP68
IP 68 fast connector



297
Adattatore per installazione
su scatola 503
Adaptor for installation like box 503

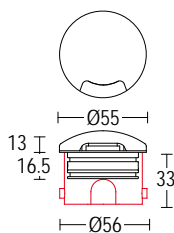

1382.ZEX.T.15 2W LED 3000K 240lm
60° \wedge
max 700mA DC
alimentatore remoto SELV non incluso
remote SELV LED driver not included

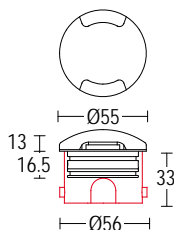

1383.ZEX.T.15 2W LED 3000K 240lm
2 x 60° \wedge
max 700mA DC
alimentatore remoto SELV non incluso
remote SELV LED driver not included

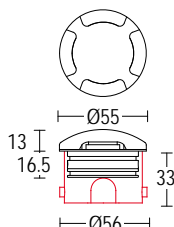

1384.ZEX.T.15 2W LED 3000K 240lm
4 x 60° \wedge
max 700mA DC
alimentatore remoto SELV non incluso
remote SELV LED driver not included

SPIA FLAT



Apparecchi da parete o da soffitto. Realizzati in alluminio pressofuso ad alta resistenza all'ossidazione. Diffusore in vetro ad alta resistenza.

Ceiling and wall lighting fixture. Made of die-cast aluminium highly resistant to oxidation. High resistance glass diffuser.

SPIA FLAT

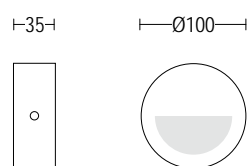

1388.CAX.O.-- 7W LED 3000K 900lm
 110° ^
 220-240V 50/60hz
 alimentatore incluso *LED driver integral*

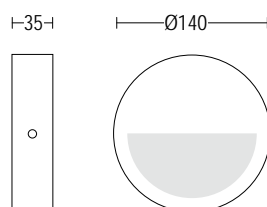

1389.EEX.O.-- 12W LED 3000K 1400lm
 110° ^
 220-240V 50/60hz
 alimentatore incluso *LED driver integral*

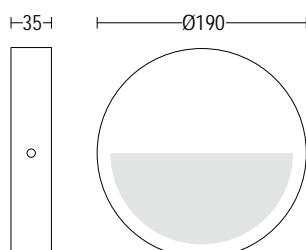

1390.HEX.O.-- 15W LED 3000K 1800lm
 110° ^
 220-240V 50/60hz
 alimentatore incluso *LED driver integral*

- .05 grigio antracite
anthracite grey
- .13 grigio chiaro
light grey

SPIA FLAT

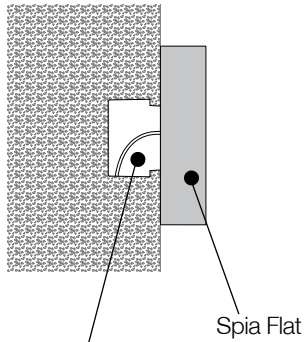

Per una corretta installazione è necessario l'utilizzo della scatola mod. 503 o equivalente.
A wall Box, 503 or equivalent, is compulsory for a proper installation.

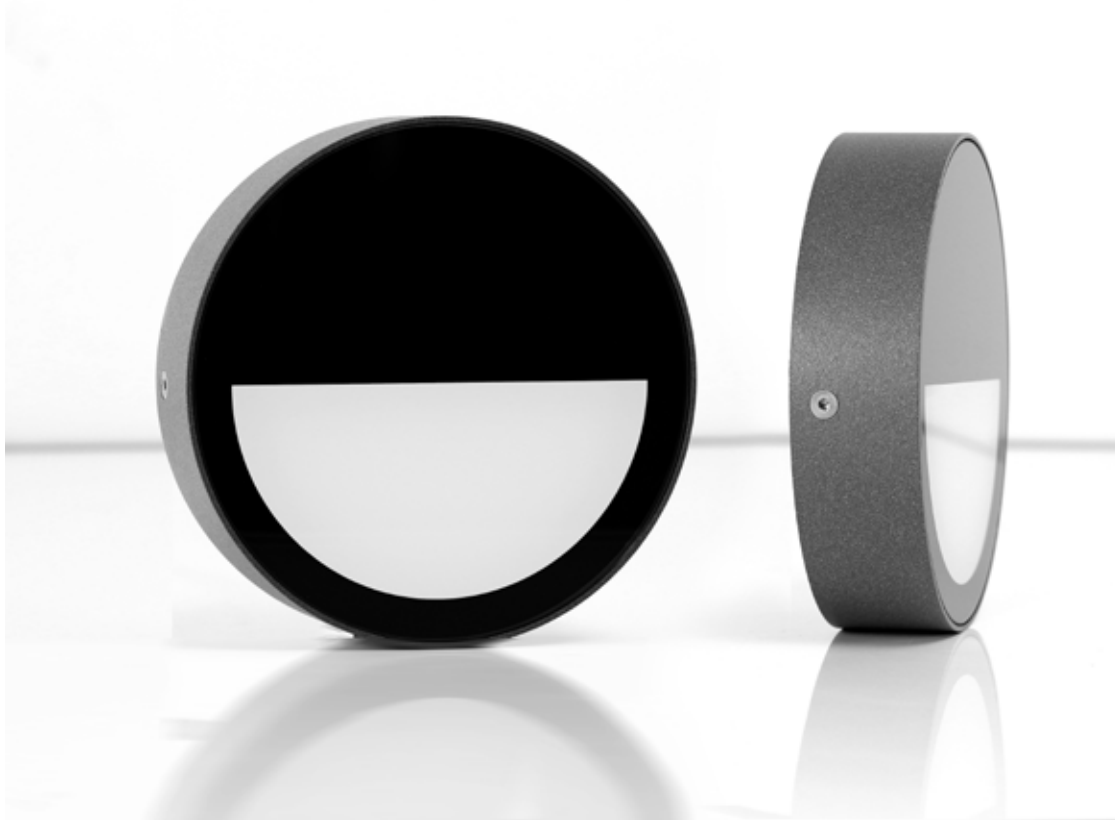

SPIA FLAT

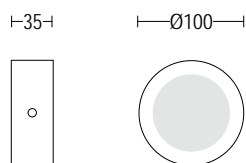

1385.CAX.O.-- 7W LED 3000K 900lm
120° \wedge
220-240V 50/60hz
alimentatore incluso *LED driver integral*

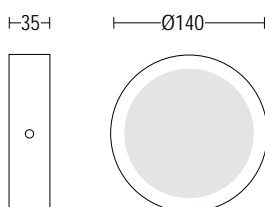

1386.EEX.O.-- 12W LED 3000K 1800lm
120° \wedge
220-240V 50/60hz
alimentatore incluso *LED driver integral*

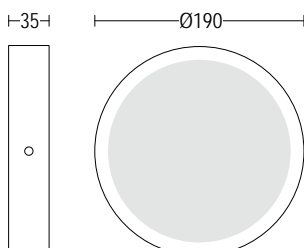

1387.HEX.O.-- 15W LED 3000K 1800lm
120° \wedge
220-240V 50/60hz
alimentatore incluso *LED driver integral*

- .05** grigio antracite
anthracite grey
- .13** grigio chiaro
light grey

MINIVERSO FLAT



Apparecchio asimmetrico a parete senza incasso, realizzato in alluminio pressofuso con emissione di luce direzionata verso il basso. Studiato per illuminare camminamenti, vialetti e scale evita qualsiasi forma di abbagliamento.

Downlight Wall luminaire particularly designed to light walkways, drives, steps without glare.

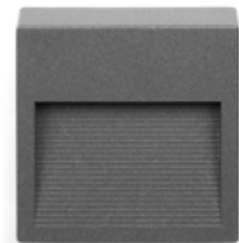

MINIVERSO FLAT

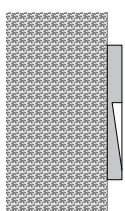
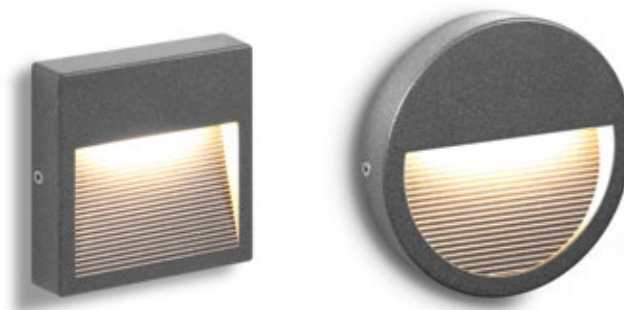

Versione a muro. Non necessita di alcuna cassaforma. Driver incluso, spessore solo 25mm.
 Surface version which does not need any rough-in housing. Driver included, and 25mm.

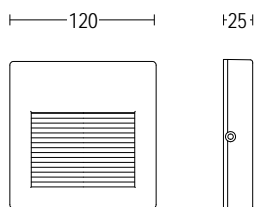

1136.ETX.T.-- 3,5W LED 3000K 410lm
 asym ^
 220-240V 50/60hz
 alimentatore incluso *LED driver integral*

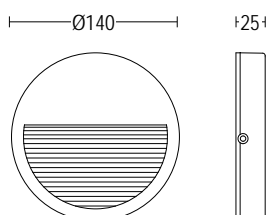

1392.FKX.T.-- 4,5W LED 3000K 640lm
 asym ^
 220-240V 50/60hz
 alimentatore incluso *LED driver integral*

- .05 grigio antracite
anthracite grey
- .13 grigio chiaro
light grey

SEGNO AS



Apparecchio da incasso a parete ad emissione di luce asimmetrica. Ideale per l'illuminazione di scale, corridoi e disimpegni. Corpo in alluminio verniciato a polveri previo trattamento di fondo che garantisce una lunga protezione nel tempo.

Recessed wall lamp with asymmetric light distribution. Ideal for lighting stairs, passageways and hallways. Body in cast aluminum finished in power coat paint with under layer protection which guarantees protection over time.



 **.15** acciaio inox
stainless steel

ACCESSORI ACCESSORIES



controcassa
rough-in housing
201 Microsegno AS
202 Segno AS
203 Maxisegno AS

Controcassa per prodotto
compatibile con alimentatore
*Rough-in housing for product
compatible with LED driver*

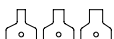

610 Microsegno
611 Segno
612 Maxisegno

Adattatore per installazione
su scatola 503
Adaptor for installation like box 503



295 Microsegno AS
296 Segno AS
297 Maxisegno AS



620-IP67
Alimentatore 350mA SELV
1 per 1-10 Segno AS 1W
*Led driver 350mA SELV
1 for 1-10 Segno AS 1W*



204
Connettore rapido IP68
IP 68 fast connector

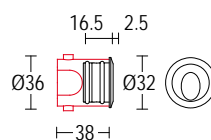

1436.BAX.O.15 1W Led 3000K 120lm
asym ^
max 350mA DC
alimentatore remoto SELV non incluso
remote SELV led driver not included

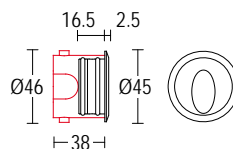

1437.BAX.O.15 1W Led 3000K 120lm
asym ^
max 350mA DC
alimentatore remoto SELV non incluso
remote SELV led driver not included

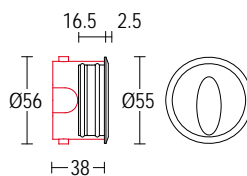

1438.BAX.O.15 1W Led 3000K 120lm
asym ^
max 350mA DC
alimentatore remoto SELV non incluso
remote SELV led driver not included

SEGNO AS SQ





 **.15** acciaio inox
stainless steel

ACCESSORI ACCESSORIES



controcassa
rough-in housing
201 Microsegno AS
202 Segno AS
203 Maxisegno AS

Controcassa per prodotto
compatibile con alimentatore
*Rough-in housing for product
compatible with LED driver*

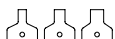

610 Microsegno
611 Segno
612 Maxisegno

Adattatore per installazione
su scatola 503
Adaptor for installation like box 503



295 Microsegno AS
296 Segno AS
297 Maxisegno AS



620-IP67
Alimentatore 350mA SELV
1 per 1-10 Segno AS 1W
*Led driver 350mA SELV
1 for 1-10 Segno AS 1W*



204
Connettore rapido IP68
IP 68 fast connector

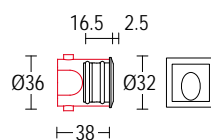

1439.BAX.O.15 1W Led 3000K 120lm
asym 
max 350mA DC
alimentatore remoto SELV non incluso
remote SELV led driver not included

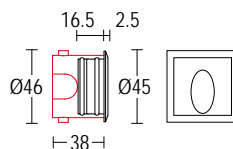

1440.BAX.O.15 1W Led 3000K 120lm
asym 
max 350mA DC
alimentatore remoto SELV non incluso
remote SELV led driver not included

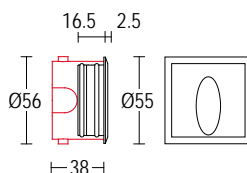

1441.BAX.O.15 1W Led 3000K 120lm
asym 
max 350mA DC
alimentatore remoto SELV non incluso
remote SELV led driver not included

SEGNO SPOT INOX RD



Point Spot è un proiettore per illuminazione d'accento dalle ridottissime dimensioni e a bassa tensione. Ideale per enfatizzare elementi architettonici, siepi o aiuole. Disponibile anche nella versione in acciaio inox.

Point Spot is a projector for accent lighting. It's elegant design makes it ideal for lighting gardens and hedges. Available in version round stainless steel.

SEGNO SPOT INOX RD

Disponibile versione 24V DC
24V DC version available

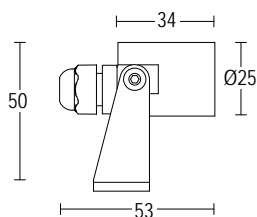

1170.BAS.T.15 1W LED 3000 K 120lm
16° ^
max 350mA DC
alimentatore remoto SELV non incluso
remote SELV LED driver not included

1170.BAM.T.15 1W LED 3000 K 120lm
32° ^
max 350mA DC
alimentatore remoto SELV non incluso
remote SELV LED driver not included

.15 acciaio inox
stainless steel

ACCESSORI ACCESSORIES



620-IP67
Alimentatore 500mA SELV
1 per 1-10 Microsegno 1W
LED driver 500mA SELV
1 for 1-10 Microsegno 1W

206-IP67
Alimentatore 500mA SELV
1 per 1-7 Segno 1,5W
LED driver 500mA SELV
1 for 1-7 Segno 1,5W

624-IP67
Alimentatore 700mA SELV
1 per 1-5 Maxisegno 2W
LED driver 700mA SELV
1 for 1-5 Maxisegno 2W



203
Picchetto
Stake



204
Connettore rapido IP68
IP 68 fast connector

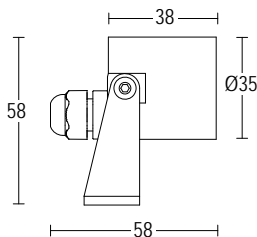

1171.BDS.T.15 1,5W LED 3000 K 170lm
13° ^
max 500mA DC
alimentatore remoto SELV non incluso
remote SELV LED driver not included

1171.BDM.T.15 1,5W LED 3000 K 170lm
47° ^
max 500mA DC
alimentatore remoto SELV non incluso
remote SELV LED driver not included

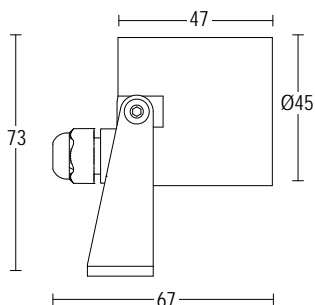

1172.BGS.T.15 2W LED 3000 K 225lm
10° ^
max 700mA DC
alimentatore remoto SELV non incluso
remote SELV LED driver not included

1172.BGM.T.15 2W LED 3000 K 225lm
37° ^
max 700mA DC
alimentatore remoto SELV non incluso
remote SELV LED driver not included

SEGNO SPOT RD



photo by: Germano Borrelli

SEGNO SPOT RD

Disponibile versione 24V DC
24V DC version available

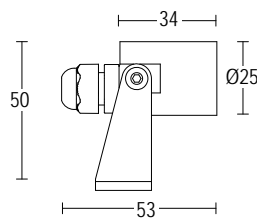

1113.BAS.T.-- 1,5W LED 3000 K 170lm
16° ^
max 500mA DC
alimentatore remoto SELV non incluso
remote SELV LED driver not included

1113.BAM.T.-- 1,5W LED 3000 K 170lm
32° ^
max 500mA DC
alimentatore remoto SELV non incluso
remote SELV LED driver not included

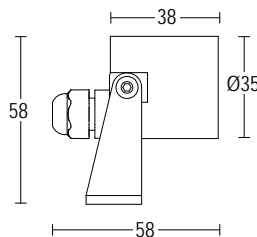

1114.BDS.T.-- 2W LED 3000 K 225lm
13° ^
max 700mA DC
alimentatore remoto SELV non incluso
remote SELV LED driver not included

1114.BDM.T.-- 2W LED 3000 K 225lm
47° ^
max 700mA DC
alimentatore remoto SELV non incluso
remote SELV LED driver not included

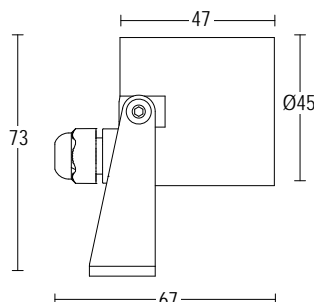

1115.BGS.T.-- 3W LED 3000 K 315lm
10° ^
max 1050mA DC
alimentatore remoto SELV non incluso
remote SELV LED driver not included

1115.BGM.T.-- 3W LED 3000 K 315lm
37° ^
max 1050mA DC
alimentatore remoto SELV non incluso
remote SELV LED driver not included

1115.AHM.T.-- 6W LED 3000 K 845lm
28° ^
max 350mA DC
alimentatore remoto SELV non incluso
remote SELV LED driver not included

1115.AHF.T.-- 6W LED 3000 K 845lm
62° ^
max 350mA DC
alimentatore remoto SELV non incluso
remote SELV LED driver not included

- .05 grigio antracite
anthracite grey
- .13 grigio chiaro
light grey

ACCESSORI ACCESSORIES



206-IP67
Alimentatore 500mA SELV
1 per 1-7 Microsegno 1,5W
LED driver 500mA SELV
1 for 1-7 Microsegno 1,5W

624-IP67
Alimentatore 700mA SELV
1 per 1-5 Segno 2W
LED driver 700mA SELV
1 for 1-5 Segno 2W

210-IP67
Alimentatore 1050mA SELV
1 per 1-4 Maxisegno 3W
LED driver 1050mA SELV
1 for 1-4 Maxisegno 3W

620-IP67
Alimentatore 350mA SELV
1 per 1-2 Maxisegno 6W
LED driver 350mA SELV
1 for 1-2 Maxisegno 6W



203
Picchetto
Stake



204
Connettore rapido IP68
IP 68 fast connector

SEGNO SPOT SQ



Con picchetto 203
With stake 203

SEGNO SPOT SQ

Disponibile versione 24V DC
24V DC version available

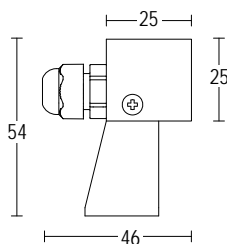

1126.BAS.T.-- 1,5W LED 3000 K 170lm
16° ^
max 500mA DC
alimentatore remoto SELV non incluso
remote SELV LED driver not included

1126.BAM.T.-- 1,5W LED 3000 K 170lm
32° ^
max 500mA DC
alimentatore remoto SELV non incluso
remote SELV LED driver not included

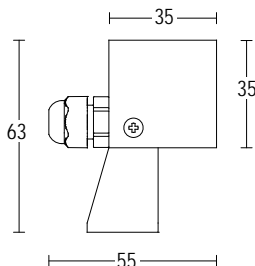

1127.BDS.T.-- 2W LED 3000 K 225lm
13° ^
max 700mA DC
alimentatore remoto SELV non incluso
remote SELV LED driver not included

1127.BDM.T.-- 2W LED 3000 K 225lm
47° ^
max 700mA DC
alimentatore remoto SELV non incluso
remote SELV LED driver not included

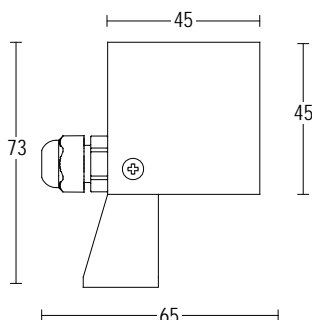

1128.BGS.T.-- 3W LED 3000 K 315lm
10° ^
max 1050mA DC
alimentatore remoto SELV non incluso
remote SELV LED driver not included

1128.BGM.T.-- 3W LED 3000 K 315lm
37° ^
max 1050mA DC
alimentatore remoto SELV non incluso
remote SELV LED driver not included

1128.AHM.T.-- 6W LED 3000 K 845lm
28° ^
max 350mA DC
alimentatore remoto SELV non incluso
remote SELV LED driver not included

1128.AHF.T.-- 6W LED 3000 K 845lm
62° ^
max 350mA DC
alimentatore remoto SELV non incluso
remote SELV LED driver not included

- .05 grigio antracite
anthracite grey
- .13 grigio chiaro
light grey

ACCESSORI ACCESSORIES



206-IP67
Alimentatore 500mA SELV
1 per 1-7 Microsegno 1,5W
LED driver 500mA SELV
1 for 1-7 Microsegno 1,5W

624-IP67
Alimentatore 700mA SELV
1 per 1-5 Segno 2W
LED driver 700mA SELV
1 for 1-5 Segno 2W

210-IP67
Alimentatore 1050mA SELV
1 per 1-4 Maxisegno 3W
LED driver 1050mA SELV
1 for 1-4 Maxisegno 3W

620-IP67
Alimentatore 350mA SELV
1 per 1-2 Maxisegno 6W
LED driver 350mA SELV
1 for 1-2 Maxisegno 6W



203
Picchetto
Stake



204
Connettore rapido IP68
IP 68 fast connector

MINIPARIO

design arch. Maurizio Parrini

Il proiettore Minipario offre soluzioni architettoniche molteplici a lighting designers ed architetti. Design essenziale, ricchezza di accessori ed elevate performances ottiche ne completano le caratteristiche. L'ampia gamma di soluzioni LED disponibili risponde alle esigenze di risparmio energetico e riduzione dei costi di manutenzione.

Minipario floodlight offers a variety of architectural solutions to both lighting designers and architects. Main distinguish characteristics are pure design, wide range of accessories and high value optic systems. The range of powerful LEDs available meets different goals, both in terms of energy savings and cost reduction for maintenance.

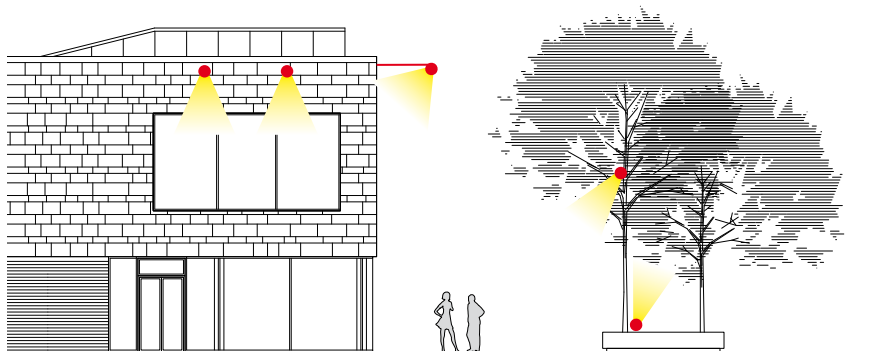

MINIPARIO



24°

40°

60°



- .05** grigio antracite
anthracite grey
- .13** grigio chiaro
light grey

ACCESSORI ACCESSORIES



224
Visiera in alluminio
aluminium hood



231
Schermo anti-abbagliamento
Louvre screen anti glare



642
Cintura di sostegno
Support belt



257
Picchetto
Stake



204
Connettore rapido IP68
IP 68 fast connector

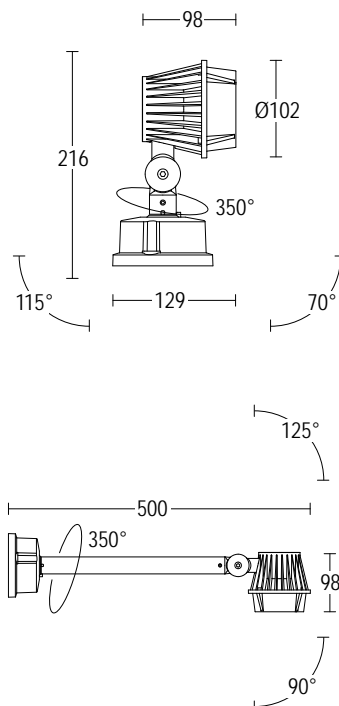

1129.BRS.T.-- 12W LED 3000K 1800lm
24° ^
220-240V 50/60hz
alimentatore incluso *LED driver integral*

1129.BRM.T.-- 12W LED 3000K 1800lm
40° ^
220-240V 50/60hz
alimentatore incluso *LED driver integral*

1129.BRF.T.-- 12W LED 3000K 1800lm
60° ^
220-240V 50/60hz
alimentatore incluso *LED driver integral*

1147.BRS.T.-- 12W LED 3000K 1800lm
24° ^
220-240V 50/60hz
alimentatore incluso *LED driver integral*

1147.BRM.T.-- 12W LED 3000K 1800lm
40° ^
220-240V 50/60hz
alimentatore incluso *LED driver integral*

1147.BRF.T.-- 12W LED 3000K 1800lm
60° ^
220-240V 50/60hz
alimentatore incluso *LED driver integral*

MICROMIKKO



Il proiettore Micromikko offre soluzioni architettoniche molteplici a lighting designers ed architetti. Design essenziale, ricchezza di accessori ed elevate performances ottiche ne completano le caratteristiche. L'ampia gamma di soluzioni LED disponibili risponde alle esigenze di risparmio energetico e riduzione dei costi di manutenzione.

Micromikko floodlight offers a variety of architectural solutions to both lighting designers and architects. Main distinguish characteristics are pure design, wide range of accessories and high value optic systems. The range of powerful LEDs available meets different goals, both in terms of energy savings and cost reduction for maintenance.



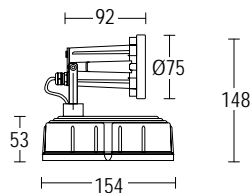

5966.CAS.T.-- 9W LED 3000K 1170lm
19° ^

220-240V 50/60hz 
alimentatore incluso *LED driver integral*

5966.CAM.T.-- 9W LED 3000K 1170lm
40° ^

220-240V 50/60hz 
alimentatore incluso *LED driver integral*

-  **.05** grigio antracite
anthracite grey
-  **.13** grigio chiaro
light grey

ACCESSORI ACCESSORIES

 **206-IP67**
Alimentatore 500mA SELV
1 per 1Micromikko 9W
*LED driver 500mA SELV
1 for 1Micromikko 9W*

 **204**
Connettore rapido IP68
IP 68 fast connector

 **224**
Visiera in alluminio
aluminium hood

 **642**
Cintura di sostegno
Support belt

 **257**
Picchetto
Stake

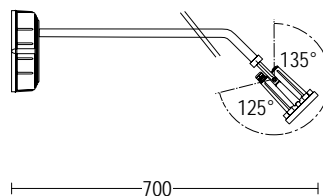

5974.CAS.T.-- 9W LED 3000K 1170lm
19° ^

220-240V 50/60hz 
alimentatore incluso *LED driver integral*

5974.CAM.T.-- 9W LED 3000K 1170lm
40° ^

220-240V 50/60hz 
alimentatore incluso *LED driver integral*

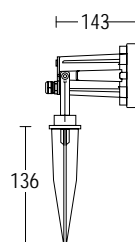

5984.CAS.T.-- 9W LED 3000 K 1170lm
19° ^

max 500mA DC 
alimentatore remoto SELV non incluso
remote SELV LED driver not included

5984.CAM.T.-- 9W LED 3000 K 1170lm
40° ^

max 500mA DC 
alimentatore remoto SELV non incluso
remote SELV LED driver not included

MICROFARO / MINIFARO FLAT



Il proiettore Minifaro flat offre soluzioni architettoniche molteplici a lighting designers ed architetti. Design essenziale, ricchezza di accessori ed elevate performances ottiche ne completano le caratteristiche. L'ampia gamma di soluzioni LED disponibili risponde alle esigenze di risparmio energetico e riduzione dei costi di manutenzione.

Minifaro floodlights offers a variety of architectural solutions to both lighting designers and architects. Main distinguish characteristics are pure design, wide range of accessories and high value optic systems. The range of powerful LEDs available meets different goals, both in terms of energy savings and cost reduction for maintenance.

MICROFARO / MINIFARO FLAT



16°

42°

- .05** grigio antracite
anthracite grey
- .13** grigio chiaro
light grey

ACCESSORI ACCESSORIES



Schermo anti-abbagliamento
Louvre screen anti glare

- 319** Microfaro flat
- 321** Minifaro flat



Cintura di sostegno
Support belt

- 644** Microfaro flat
- 654** Minifaro flat



203
Picchetto
Stake



204
Connettore rapido IP68
IP 68 fast connector

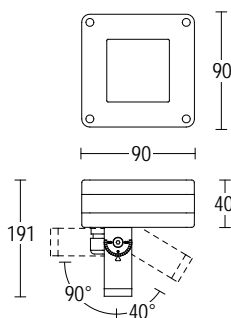

1396.AHF.T.-- 8W LED 3000K 720lm
29° ^
220-240V 50/60hz
alimentatore incluso *LED driver integral*

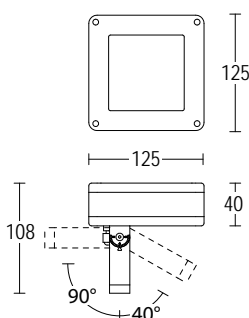

1397.GZS.T.-- 15W LED 3000K 1425lm
16° ^
220-240V 50/60hz
alimentatore incluso *LED driver integral*

1397.GZF.T.-- 15W LED 3000K 1425lm
42° ^
220-240V 50/60hz
alimentatore incluso *LED driver integral*

MICROFARO / MINIFARO



Il proiettore Minifaro offre soluzioni architettoniche molteplici a lighting designers ed architetti. Design essenziale, ricchezza di accessori ed elevate performances ottiche ne completano le caratteristiche. L'ampia gamma di soluzioni LED disponibili risponde alle esigenze di risparmio energetico e riduzione dei costi di manutenzione.

Minifaro floodlights offers a variety of architectural solutions to both lighting designers and architects. Main distinguish characteristics are pure design, wide range of accessories and high value optic systems. The range of powerful LEDs available meets different goals, both in terms of energy savings and cost reduction for maintenance.



MICROFARO / MINIFARO

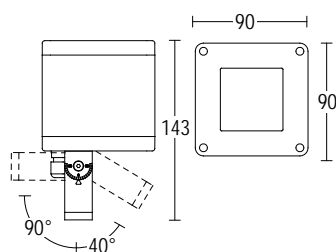

1132.AHF.T.-- 7W LED 3000 K 1045lm
 32° ^
 220-240V 50/60hz
 alimentatore incluso *LED driver integral*

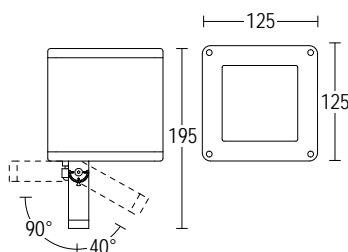

1133.DGS.T.-- 16W LED 3000K 2270lm
 14° ^
 220-240V 50/60hz
 alimentatore incluso *LED driver integral*

1133.DGF.T.-- 16W LED 3000K 2270lm
 35° ^
 220-240V 50/60hz
 alimentatore incluso *LED driver integral*

1133.FNS.T.-- 29W LED 3000K 3870lm
 14° ^
 220-240V 50/60hz
 alimentatore incluso *LED driver integral*

1133.FNF.T.-- 29W LED 3000K 3870lm
 35° ^
 220-240V 50/60hz
 alimentatore incluso *LED driver integral*

- .05 grigio antracite
anthracite grey
- .13 grigio chiaro
light grey

ACCESSORI ACCESSORIES



Schermo anti-abbagliamento
Louvre screen anti glare
319 Microfaro
321 Minifaro



Cintura di sostegno
Support belt
644 Microfaro
654 Minifaro



203
Picchetto
Stake



204
Connettore rapido IP68
IP 68 fast connector

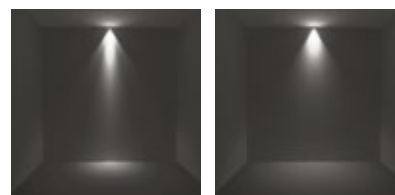

14°

35°

COMPATTO

Compatto è un proiettore a parete dalle ridottissime dimensioni realizzato in alluminio estruso ad alta resistenza all'ossidazione. E' dotato di un sofisticato sistema ottico ad uno o due fasci di diverse ampiezze. L'apparecchio è stato ideato per l'illuminazione d'effetto di pareti e facciate.

Compatto is a cleverly designed compact wall luminaire made in extruded aluminum high resistance to oxidation. LEDs light sources with sophisticated optical technology to provide a combination of different beams for up and down lighting applications. Compatto is particularly suitable for lighting facades in a small architectural environment.

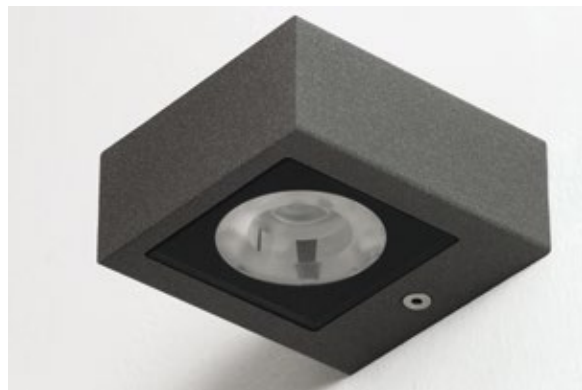



-  **.05** grigio antracite
anthracite grey
-  **.13** grigio chiaro
light grey

ACCESSORI ACCESSORIES

206 (IP 20)
Alimentatore 500mA SELV
1 per 1-2 Compatto 9W
1 per 1 Compatto 18W
LED driver 500mA SELV
1 for 1-2 Compatto 9W
1 for 1 Compatto 18W

206-IP67 (IP 67)
Alimentatore 500mA SELV
1 per 1-2 Compatto 9W
LED driver 500mA SELV
1 for 1-2 Compatto 9W

228-IP67 (IP 67)
Alimentatore 500mA SELV
1 per 1 Compatto 18W
LED driver 500mA SELV
1 for 1 Compatto 18W

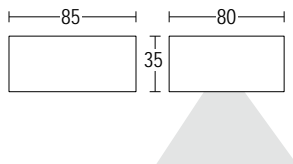

1143.AHF.T.-- 6W LED 3000K 540lm
40° ^
220-240V 50/60hz 
alimentatore incluso *LED driver integral*

1143.CAF.T.-- 9W LED 3000K 1170lm
40° ^
max 500mA DC 
alimentatore remoto SELV non incluso
remote SELV LED driver not included

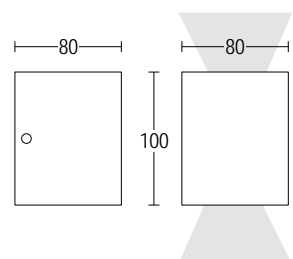

1144.BRF.T.-- 12W LED 3000K 2 x 540lm
40° ^
220-240V 50/60hz 
alimentatore incluso *LED driver integral*

1144.L3S.T.-- 18W LED 3000K 2 x 1170lm
40° ^
max 500mA DC 
alimentatore remoto SELV non incluso
remote SELV LED driver not included

MINIMODO

Proiettore per effetto parete in alluminio pressofuso, IP 65. Consente l'impiego di lampade alogene, fluorescenti e LED. E' adatto per medie strutture architettoniche e abitazioni private per personalizzare e arredare con la luce e illuminare luoghi di passaggio. Vi è la possibilità di avere combinazioni di fasci stretti e larghi creando effetti luminosi accattivanti.

Die-cast aluminium wall-effect light, IP 65. Fitted use with halogen, fluorescent lamps and LEDs. It is suitable for medium sized architectural, commercial and residential use. You can combine narrow and wide beams, creating eye-catching light effects.



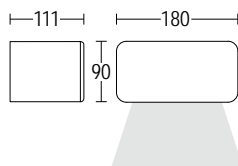

1330.BGX.B.-- 4W LED 3000K 640lm
110° ^
220-240V 50/60hz
alimentatore incluso *LED driver integral*

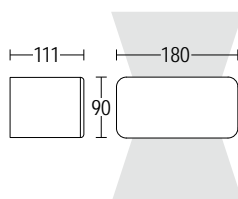

1333.LVX.B.-- 8W LED 3000K 2 x 640lm
110° ^
220-240V 50/60hz
alimentatore incluso *LED driver integral*

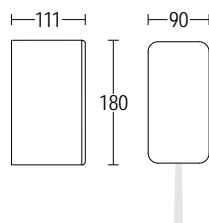

1363.S8X.T.-- 3W LED 3000K 350lm
3° ^
220-240V 50/60hz
alimentatore incluso *LED driver integral*

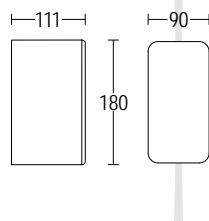

1364.S8X.T.-- 6W LED 3000K 2 x 350lm
3° ^
220-240V 50/60hz
alimentatore incluso *LED driver integral*

- .05** grigio antracite
anthracite grey
- .13** grigio chiaro
light grey

MICROBIVIO

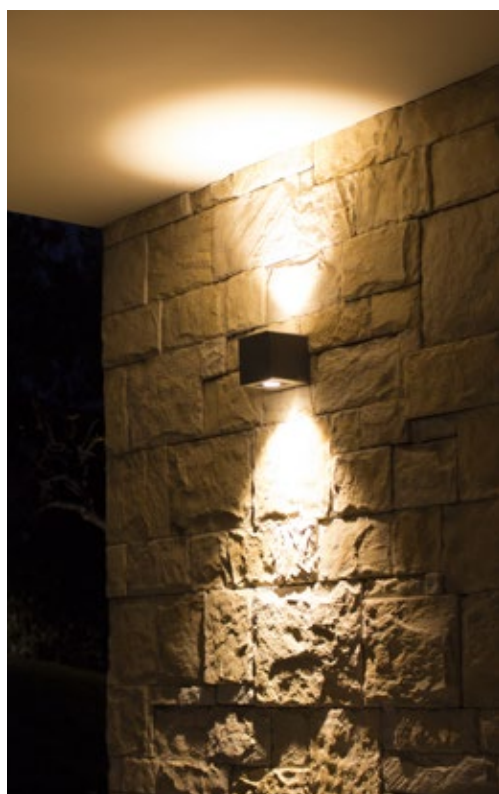

Proiettore a parete compatto realizzato in alluminio pressofuso ad alta resistenza all'ossidazione. E' dotato di un sofisticato sistema ottico ad uno o due fasci di diverse ampiezze. L'apparecchio è stato ideato per l'illuminazione d'effetto di pareti e facciate.

Microbivio is a cleverly designed compact wall luminaire made in die-cast aluminum high resistance to oxidation. LEDs light sources with sophisticated optical technology to provide a combination of different beams for up and down lighting applications. Microbivio is particularly suitable for lighting facades in a small architectural environment.

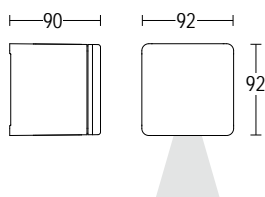

1152.BGF.T.-- 3,5W LED 3000K 545lm
 32° ^
 220-240V 50/60hz
 alimentatore incluso *LED driver integral*

1152.AHF.T.-- 7W LED 3000K 1045lm
 32° ^
 220-240V 50/60hz
 alimentatore incluso *LED driver integral*

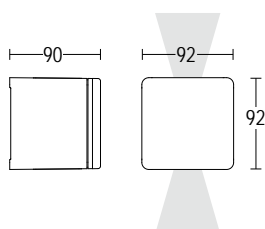

1153.DDF.T.-- 7W LED 3000K 2 x 545lm
 32° ^
 220-240V 50/60hz
 alimentatore incluso *LED driver integral*

-  **.05** grigio antracite
anthracite grey
-  **.13** grigio chiaro
light grey

MINIBIVIO

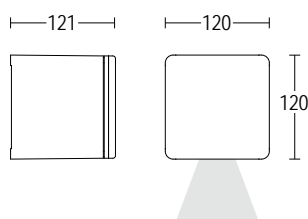
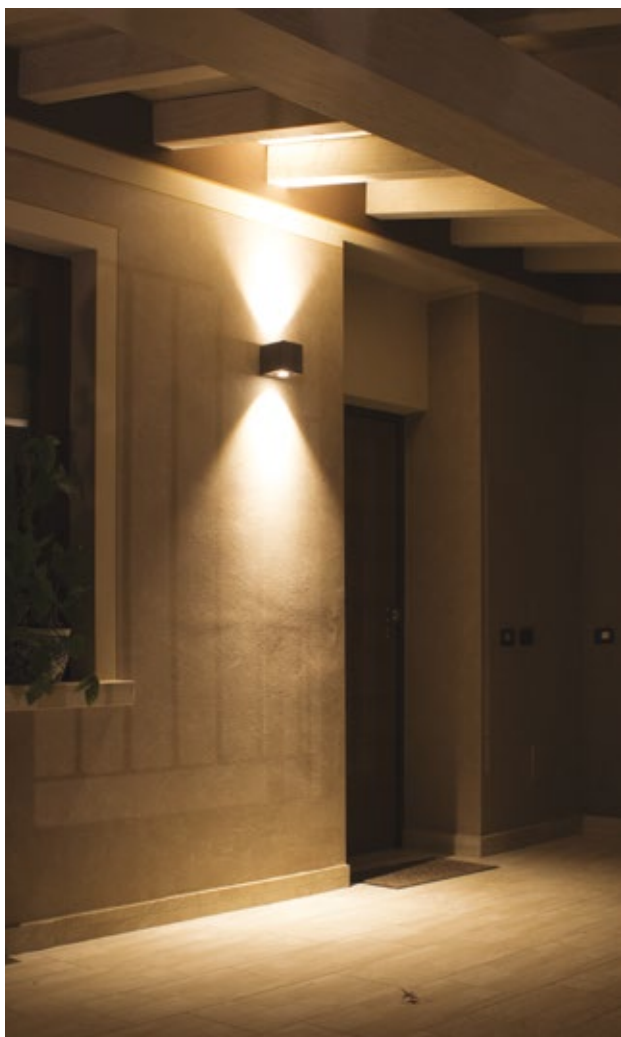

1154.AHF.T.-- 6W LED 3000K 900lm
 36° ^
 220-240V 50/60hz
 alimentatore incluso *LED driver integral*

1154.BRF.T.-- 13W LED 3000K 1800lm
 36° ^
 220-240V 50/60hz
 alimentatore incluso *LED driver integral*

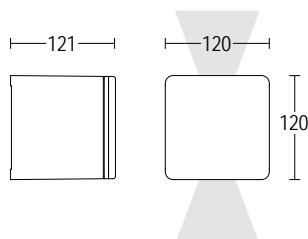

1155.ERF.T.-- 12W LED 3000K 2 x 900lm
 32° ^
 220-240V 50/60hz
 alimentatore incluso *LED driver integral*

- .05** grigio antracite
anthracite grey
- .13** grigio chiaro
light grey

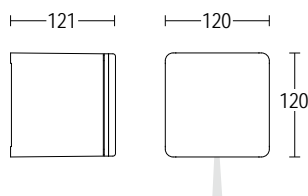

1163.BAX.T.-- 1,5W LED 3000K 160lm
 6° \wedge
 220-240V 50/60hz
 alimentatore incluso *LED driver integral*

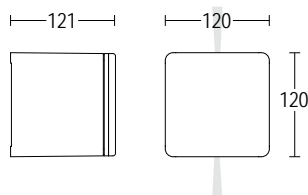

1159.BGX.T.-- 3W LED 3000K 2 x 160lm
 6° \wedge
 220-240V 50/60hz
 alimentatore incluso *LED driver integral*

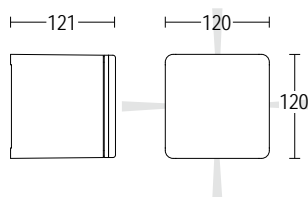

1160.AHX.T.-- 6W LED 3000K 4 x 160lm
 6° \wedge
 220-240V 50/60hz
 alimentatore incluso *LED driver integral*

- .05** grigio antracite
anthracite grey
- .13** grigio chiaro
light grey

MICROTORRE



Proiettore a parete compatto realizzato in alluminio pressofuso ad alta resistenza all'ossidazione. E' dotato di un sofisticato sistema ottico ad uno o due fasci di diverse ampiezze. L'apparecchio è stato ideato per l'illuminazione d'effetto di pareti e facciate.

Minitorre is a cleverly designed compact wall luminaire made of die-cast aluminium high resistance to oxidation. It incorporates metal halide and LEDs light sources with sophisticated optical technology to provide a combination of different beams for up and down lighting applications. TORRE is particularly appropriate for lighting facades in the architectural environment.

MICROTORRE

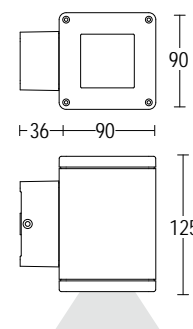
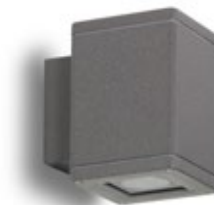

1960.AHF.T-- 6W LED 3000K 900 lm
32° ^
220-240V 50/60hz
alimentatore incluso *LED driver integral*

1960.BRF.T-- 12W LED 3000K 1800lm
32° ^
220-240V 50/60hz
alimentatore incluso *LED driver integral*

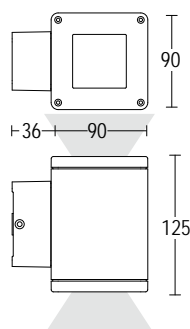

1961.ERF.T-- 12W LED 3000K 2 x 900lm
32° ^
220-240V 50/60hz
alimentatore incluso *LED driver integral*

- .05** grigio antracite
anthracite grey
- .13** grigio chiaro
light grey

MINITORRE



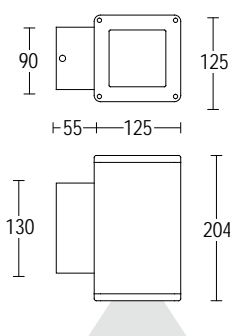

1958.DGFT.-- 16W LED 3000K 2270lm
 35° ^
 220-240V 50/60hz
 alimentatore incluso *LED driver integral*

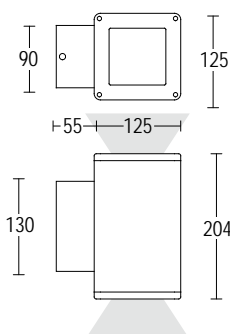

1959.GNFT.-- 32W LED 3000K 2 x 2270lm
 35° ^
 220-240V 50/60hz
 alimentatore incluso *LED driver integral*

- .05** grigio antracite
anthracite grey
- .13** grigio chiaro
light grey

TRATTO WALL

Tratto Wall è un proiettore lineare a parete dalle ridotte dimensioni. Corpo in alluminio pressofuso ed estruso ad alta resistenza all'ossidazione, diffusore in vetro temperato. L'orientabilità ha un'ampiezza di 180° ed è garantita da un sistema a ghiera graduata con progressione di 10°. Ideale per l'enfatizzazione di facciate o cornicioni.

Tratto Wall is a compact linear flood light. Body in die cast and extruded aluminum which is highly resistant to oxidation. Adjustable 180° with a graduated lock system adjustable by 10°. Ideal for emphasizing facades and buildings.



TRATTO WALL



- .05** grigio antracite
anthracite grey
- .13** grigio chiaro
light grey

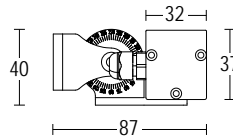

ACCESSORI ACCESSORIES



Alimentatore 24VDC IP 67 SELV
IP 67 LED driver 24VDC SELV
565-IP67 15W 24VDC
621-IP67 40W 24VDC
547-IP67 120W 24VDC



566
Braccio di estensione
150-300 mm
*150-300 mm
extension arm*



Griglia anti-abbagliamento
anti glare louvre
636 Tratto 300
637 Tratto 600
638 Tratto 900
639 Tratto 1200



289
Scatola IP 66
per alimentatore remoto
*IP 66 box for
remote LED driver*



279
Connettore per
cablaggio in cascata IP 68
*IP 68 connector
for through wiring*

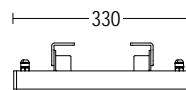

1533.FKX.O.-- 4W LED 3000K 360lm
118° ^
24VDC
alimentatore remoto SELV non incluso
remote SELV LED driver not included

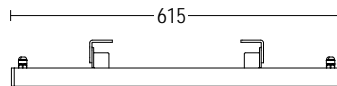

1534.P1X.O.-- 9W LED 3000K 720lm
118° ^
24VDC
alimentatore remoto SELV non incluso
remote SELV LED driver not included

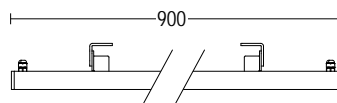

1536.GLX.O.-- 12W LED 3000K 1020lm
118° ^
24VDC
alimentatore remoto SELV non incluso
remote SELV LED driver not included

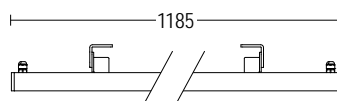

1537.LRX.O.-- 16W LED 3000K 1380lm
118° ^
24VDC
alimentatore remoto SELV non incluso
remote SELV LED driver not included

VISO

Viso è una plafoniera in alluminio pressofuso, con diffusore in vetro temprato. E' adatta per l'illuminazione di porticati, corti d'ingresso o verande.

Viso is a die cast aluminium surface mounted, with tempered glass diffuser. It is ideal for both indoor and outdoor applications.





-  **.05** grigio antracite
anthracite grey
-  **.13** grigio chiaro
light grey

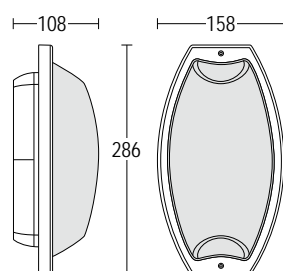

1314.BRX.S.-- 6,5W LED 3000K 1020lm
130° \wedge
220-240V 50/60hz
alimentatore incluso *LED driver integral*

1314.36F.S.T.-- max 60W E27
160° \wedge
220-240V 50/60hz

PUNTO RD

Apparecchio a soffitto dalle ridottissime dimensioni, dal design minimale, realizzato in alluminio pressofuso ad alta resistenza all'ossidazione. Ideale per l'illuminazione di porticati, piccole tettoie o verande.

Punto is a super compact ceiling products with minimal design and compact size. Ideal for accent lighting in residential and commercial areas with minimum impact. Particularly suitable for environments where an high IP rating is required.





-  **.05** grigio antracite
anthracite grey
-  **.13** grigio chiaro
light grey

ACCESSORI ACCESSORIES



206-IP67
Alimentatore 500mA SELV
1 per 1-7 Micropunto 1,5W
LED driver 500mA SELV
1 for 1-7 Micropunto 1,5W

624-IP67
Alimentatore 700mA SELV
1 per 1-5 Punto 2W
LED driver 700mA SELV
1 for 1-5 Punto 2W

210-IP67
Alimentatore 1050mA SELV
1 per 1-4 Maxipunto 3W
LED driver 1050mA SELV
1 for 1-4 Maxipunto 3W

620-IP67
Alimentatore 350mA SELV
1 per 1-2 Maxipunto 6W
LED driver 350mA SELV
1 for 1-2 Maxipunto 6W

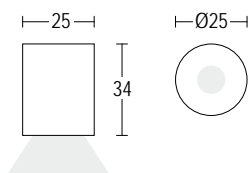

1430.BAM.T.-- 1,5W LED 3000K 170lm
32° ^
max 500mA DC
alimentatore remoto SELV non incluso
remote SELV LED driver not included

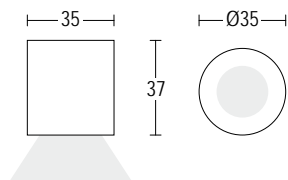

1431.BDM.T.-- 2W LED 3000K 225lm
47° ^
max 700mA DC
alimentatore remoto SELV non incluso
remote SELV LED driver not included

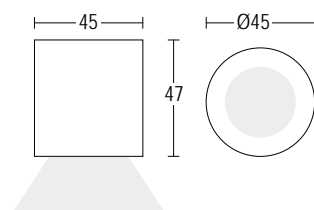

1432.BGM.T.-- 3W LED 3000K 315lm
37° ^
max 1050mA DC
alimentatore remoto SELV non incluso
remote SELV LED driver not included

1432.AHF.T.-- 6W LED 3000K 845lm
62° ^
max 350mA DC
alimentatore remoto SELV non incluso
remote SELV LED driver not included

PUNTO SQ





-  **.05** grigio antracite
anthracite grey
-  **.13** grigio chiaro
light grey

ACCESSORIES



206-IP67
Alimentatore 500mA SELV
1 per 1-7 Micropunto 1,5W
LED driver 500mA SELV
1 for 1-7 Micropunto 1,5W

624-IP67
Alimentatore 700mA SELV
1 per 1-5 Punto 2W
LED driver 700mA SELV
1 for 1-5 Punto 2W

210-IP67
Alimentatore 1050mA SELV
1 per 1-4 Maxipunto 3W
LED driver 1050mA SELV
1 for 1-4 Maxipunto 3W

620-IP67
Alimentatore 350mA SELV
1 per 1-2 Maxipunto 6W
LED driver 350mA SELV
1 for 1-2 Maxipunto 6W

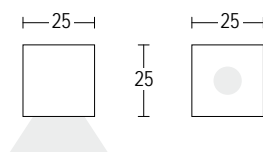

1433.BAM.T-- 1,5W LED 3000K 170lm
32° \wedge
max 500mA DC
alimentatore remoto SELV non incluso
remote SELV LED driver not included

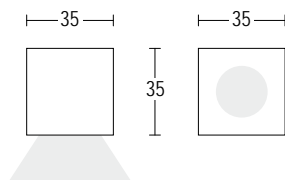

1434.BDM.T-- 2W LED 3000K 225lm
47° \wedge
max 700mA DC
alimentatore remoto SELV non incluso
remote SELV LED driver not included

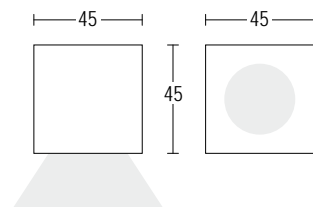

1435.BGM.T-- 3W LED 3000K 315lm
37° \wedge
max 1050mA DC
alimentatore remoto SELV non incluso
remote SELV LED driver not included

1435.AHF.T-- 6W LED 3000K 845lm
62° \wedge
max 350mA DC
alimentatore remoto SELV non incluso
remote SELV LED driver not included

NANOTORRE SOFFITTO



Apparecchio a soffitto compatto, dal design minimale, realizzato in alluminio pressofuso ad alta resistenza all'ossidazione. Ideale per l'illuminazione di porticati, piccole tettoie o verande.

Nanotorre is a ceiling products with minimal design and compact size. Ideal for accent lighting in residential and commercial areas with minimum impact. Particularly suitable for environments where an high IP rating is required.

NANOTORRE SOFFITTO



- .05** grigio antracite
anthracite grey
- .13** grigio chiaro
light grey

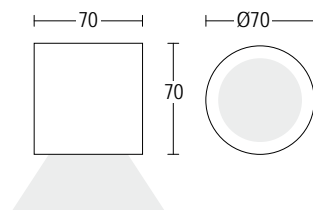

1220.LVF.T.-- 6W LED 3000K 540lm
36° ^
220-240V 50/60hz
alimentatore incluso *LED driver integral*

MICROTORRE / MINITORRE SOFFITTO FLAT

Apparecchio a soffitto compatto, dal design minimale, realizzato in alluminio pressofuso ad alta resistenza all'ossidazione. Ideale per l'illuminazione di porticati, piccole tettoie o verande.

Torre Flat is a ceiling products with minimal design and compact size. Ideal for accent lighting in residential and commercial areas with minimum impact. Particularly suitable for environments where an high IP rating is required.



MICROTORRE / MINITORRE SOFFITTO FLAT

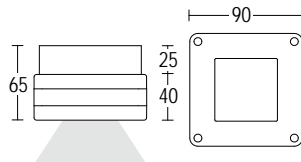
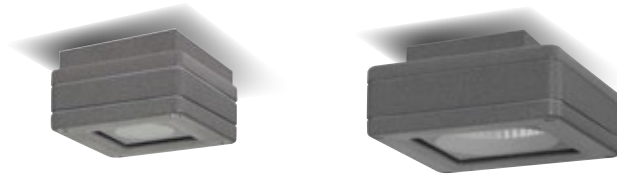

1208.AHF.T.-- 8W LED 3000K 660lm
29° ^
220-240V 50/60hz
alimentatore incluso *LED driver integral*

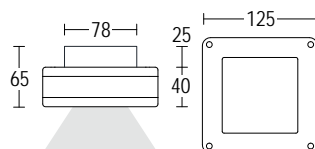

1209.GZF.T.-- 15W LED 3000K 1425lm
42° ^
220-240V 50/60hz
alimentatore incluso *LED driver integral*

- .05 grigio antracite
anthracite grey
- .13 grigio chiaro
light grey

MICROTORRE / MINITORRE SOFFITTO



Apparecchio a soffitto compatto, dal design minimale, realizzato in alluminio pressofuso ad alta resistenza all'ossidazione. Ideale per l'illuminazione di porticati, piccole tettoie o verande.

Minitorre is a ceiling products with minimal design and compact size. Ideal for accent lighting in residential and commercial areas with minimum impact. Particularly suitable for environments where an high IP rating is required.

MICROTORRE / MINITORRE SOFFITTO

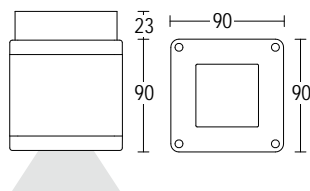
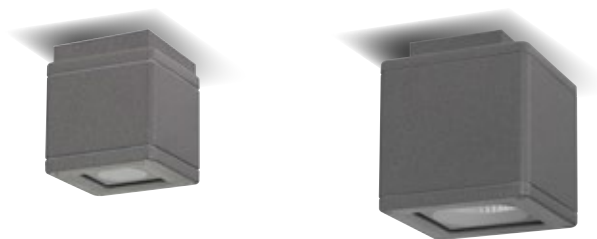

1962.AHF.T.-- 7W LED 3000K 1045lm
32° ^
220-240V 50/60hz
alimentatore incluso *LED driver integral*

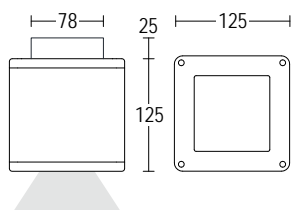

1963.DGF.T.-- 16W LED 3000K 2270lm
36° ^
220-240V 50/60hz
alimentatore incluso *LED driver integral*

- .05** grigio antracite
anthracite grey
- .13** grigio chiaro
light grey

MINIZAC!

design A.Saggia & V.Sommella



Bollard asimmetrico dal design innovativo e accattivante. Altamente resistente all'ossidazione, grazie alla sua realizzazione in alluminio pressofuso, si presta particolarmente all'illuminazione di vialetti, camminamenti e aiuole.

Asymmetric bollard with an innovative design made in extruded aluminium which is highly resistant to oxidation and particularly suitable for the lighting of paths, walkways and gardens.

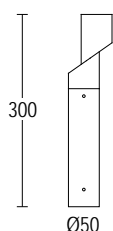
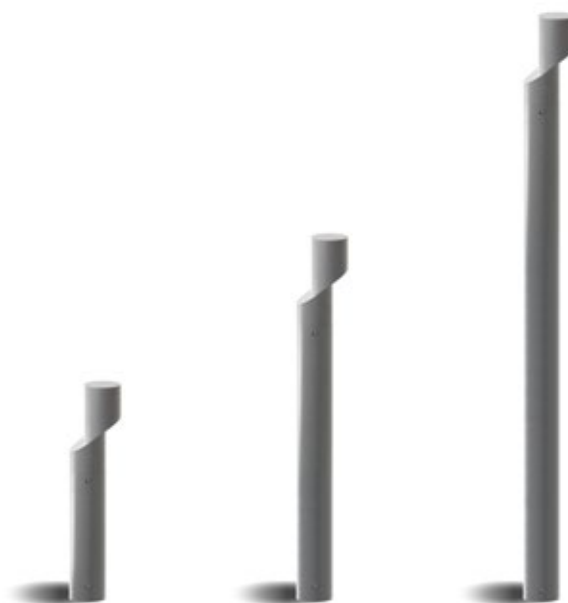

1250.AHX.A-- 6 W Led 3000 K 700 lm
220-240 V 50/60 HZ
alimentatore incluso *led driver integral*

1250.BRX.A-- 12 W Led 3000 K 1220 lm
220-240 V 50/60 HZ
alimentatore incluso *led driver integral*

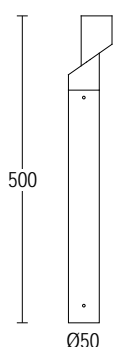

1251.AHX.A-- 6 W Led 3000 K 700 lm
220-240 V 50/60 HZ
alimentatore incluso *led driver integral*

1251.BRX.A-- 12 W Led 3000 K 1220 lm
220-240 V 50/60 HZ
alimentatore incluso *led driver integral*

-  **.05** grigio antracite
anthracite grey
-  **.13** grigio chiaro
light grey

ACCESSORI ACCESSORIES



238
codice base di ancoraggio
plated steel anchorage code



204
Connettore rapido IP68
IP 68 fast connector



279
Connettore per
cablaggio in cascata IP 68
*IP 68 connector
for through wiring*

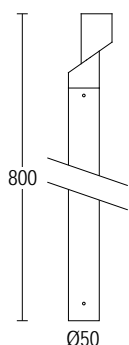

1252.AHX.A-- 6 W Led 3000 K 700 lm
220-240 V 50/60 HZ
alimentatore incluso *led driver integral*

1252.BRX.A-- 12 W Led 3000 K 1220 lm
220-240 V 50/60 HZ
alimentatore incluso *led driver integral*

ZAC!

design A.Saggia & V.Sommella





-  **.05** grigio antracite
anthracite grey
-  **.13** grigio chiaro
light grey

ACCESSORI ACCESSORIES



248
codice base di ancoraggio
plated steel anchorage code



204
Connettore rapido IP68
IP 68 fast connector



279
Connettore per
cablaggio in cascata IP 68
*IP 68 connector
for through wiring*

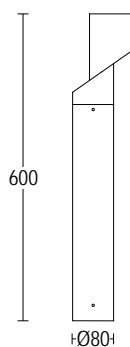

1253.AHX.A.-- 6 W Led 3000 K 700 lm
220-240 V 50/60 HZ
alimentatore incluso led driver integral

1253.BRX.A.-- 12 W Led 3000 K 1220 lm
220-240 V 50/60 HZ
alimentatore incluso led driver integral

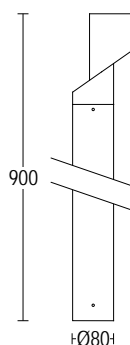

1254.AHX.A.-- 6 W Led 3000 K 700 lm
220-240 V 50/60 HZ
alimentatore incluso led driver integral

1254.BRX.A.-- 12 W Led 3000 K 1220 lm
220-240 V 50/60 HZ
alimentatore incluso led driver integral

MINITONDO INOX



Bollard dal design minimale. Altamente resistente all'ossidazione, grazie alla sua realizzazione in alluminio pressofuso, si presta particolarmente all'illuminazione di vialetti, camminamenti e aiuole. Versatile nel suo utilizzo grazie alle due emissioni a 360° o 180°.

Bollard made in extruded aluminium which is highly resistant to oxidation and particularly suitable for the lighting of paths, walkways and gardens. Available with 360° and 180° emission.

MINITONDO INOX 180°

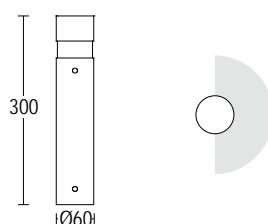
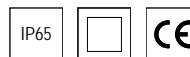

1447.LVX.T.15 6W LED 3000K 770lm
220-240V 50/60hz
alimentatore incluso *LED driver integral*

1447.BRX.T.15 12W LED 3000K 1700lm
220-240V 50/60hz
alimentatore incluso *LED driver integral*

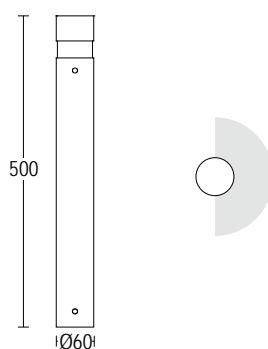

1448.LVX.T.15 6W LED 3000K 770lm
220-240V 50/60hz
alimentatore incluso *LED driver integral*

1448.BRX.T.15 12W LED 3000K 1700lm
220-240V 50/60hz
alimentatore incluso *LED driver integral*

.15 acciaio inox
stainless steel

ACCESSORI ACCESSORIES



272
codice base di ancoraggio
plated steel anchorage code



204
Connettore rapido IP68
IP 68 fast connector



279
Connettore per
cablaggio in cascata IP 68
*IP 68 connector
for through wiring*

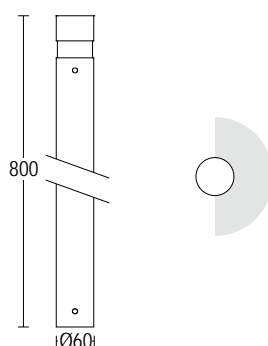

1449.LVX.T.15 6W LED 3000K 770lm
220-240V 50/60hz
alimentatore incluso *LED driver integral*

1449.BRX.T.15 12W LED 3000K 1700lm
220-240V 50/60hz
alimentatore incluso *LED driver integral*

MINITONDO INOX

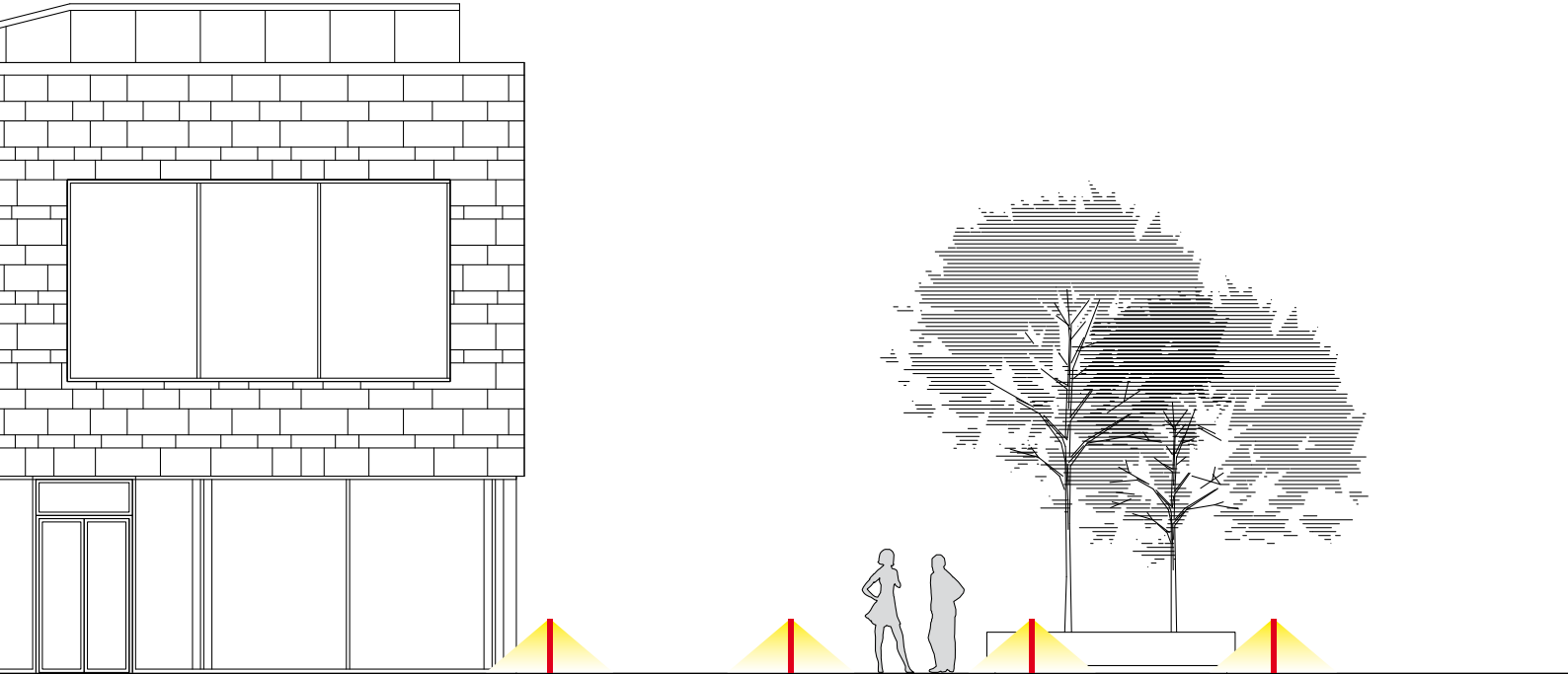

MINITONDO INOX 360°

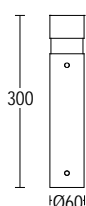
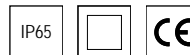

1415.LVX.T.15 6W LED 3000K 770lm
220-240V 50/60hz
alimentatore incluso *LED driver integral*

1415.BRX.T.15 12W LED 3000K 1700lm
220-240V 50/60hz
alimentatore incluso *LED driver integral*

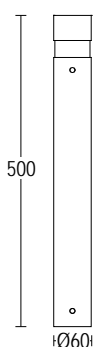

1416.LVX.T.15 6W LED 3000K 770lm
220-240V 50/60hz
alimentatore incluso *LED driver integral*

1416.BRX.T.15 12W LED 3000K 1700lm
220-240V 50/60hz
alimentatore incluso *LED driver integral*

.15 acciaio inox
stainless steel

ACCESSORI ACCESSORIES



272
codice base di ancoraggio
plated steel anchorage code



204
Connettore rapido IP68
IP 68 fast connector



279
Connettore per
cablaggio in cascata IP 68
*IP 68 connector
for through wiring*

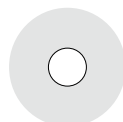
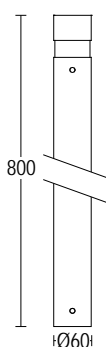

1417.LVX.T.15 6W LED 3000K 770lm
220-240V 50/60hz
alimentatore incluso *LED driver integral*

1417.BRX.T.15 12W LED 3000K 1700lm
220-240V 50/60hz
alimentatore incluso *LED driver integral*

MINITONDO 180°

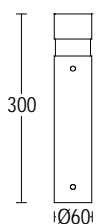
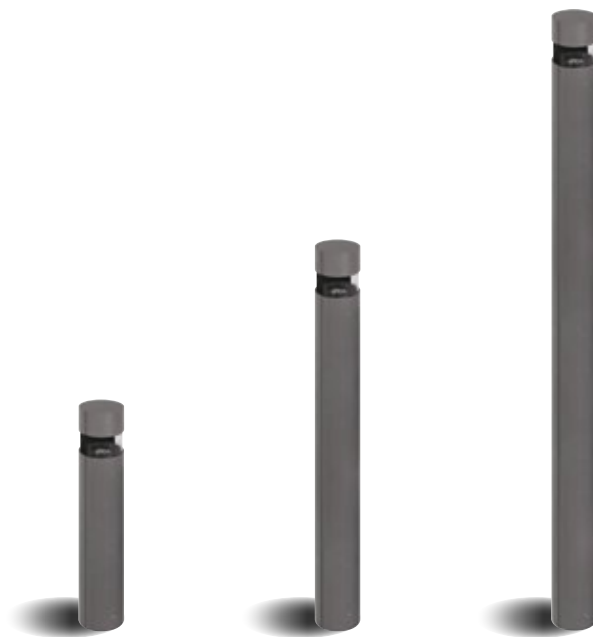

1447.LVX.T.-- 6W LED 3000K 770lm
220-240V 50/60hz
alimentatore incluso *LED driver integral*

1447.BRX.T.-- 12W LED 3000K 1700lm
220-240V 50/60hz
alimentatore incluso *LED driver integral*

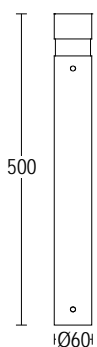

1448.LVX.T.-- 6W LED 3000K 770lm
220-240V 50/60hz
alimentatore incluso *LED driver integral*

1448.BRX.T.-- 12W LED 3000K 1700lm
220-240V 50/60hz
alimentatore incluso *LED driver integral*

- .05** grigio antracite
anthracite grey
- .13** grigio chiaro
light grey

ACCESSORI ACCESSORIES



272
codice base di ancoraggio
plated steel anchorage code



204
Connettore rapido IP68
IP 68 fast connector



279
Connettore per
cablaggio in cascata IP 68
*IP 68 connector
for through wiring*

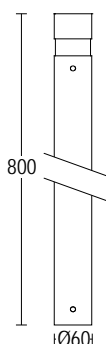

1449.LVX.T.-- 6W LED 3000K 770lm
220-240V 50/60hz
alimentatore incluso *LED driver integral*

1449.BRX.T.-- 12W LED 3000K 1700lm
220-240V 50/60hz
alimentatore incluso *LED driver integral*

MINITONDO 360°

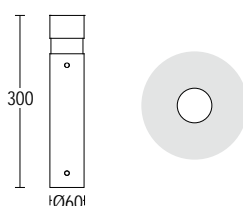
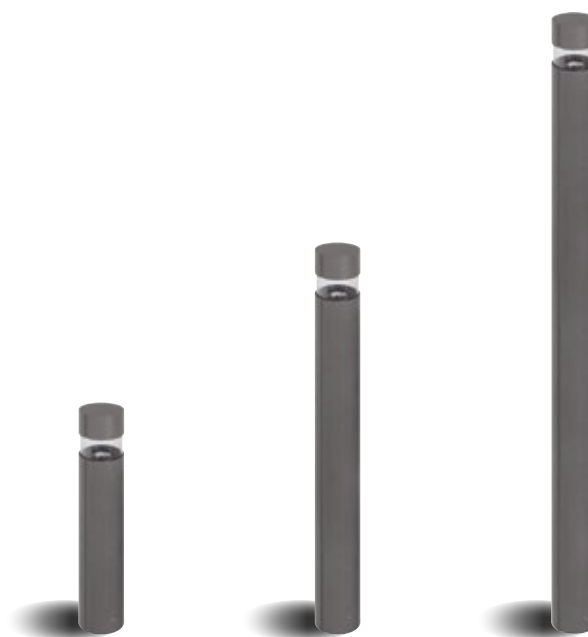
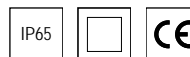

1415.LVX.T.-- 6W LED 3000K 770lm
220-240V 50/60hz
alimentatore incluso *LED driver integral*

1415.BRX.T.-- 12W LED 3000K 1700lm
220-240V 50/60hz
alimentatore incluso *LED driver integral*

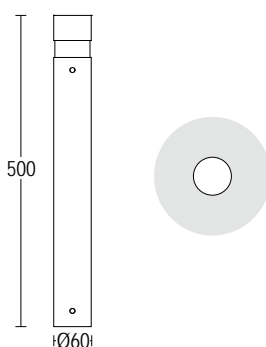

1416.LVX.T.-- 6W LED 3000K 770lm
220-240V 50/60hz
alimentatore incluso *LED driver integral*

1416.BRX.T.-- 12W LED 3000K 1700lm
220-240V 50/60hz
alimentatore incluso *LED driver integral*

- .05** grigio antracite
anthracite grey
- .13** grigio chiaro
light grey

ACCESSORI ACCESSORIES



272
codice base di ancoraggio
plated steel anchorage code



204
Connettore rapido IP68
IP 68 fast connector



279
Connettore per
cablaggio in cascata IP 68
*IP 68 connector
for through wiring*

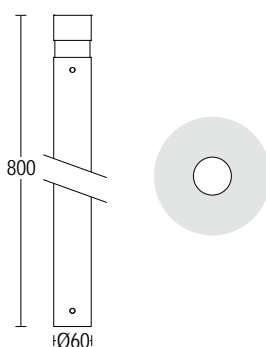

1417.LVX.T.-- 6W LED 3000K 770lm
220-240V 50/60hz
alimentatore incluso *LED driver integral*

1417.BRX.T.-- 12W LED 3000K 1700lm
220-240V 50/60hz
alimentatore incluso *LED driver integral*

TONDO



TONDO 180°

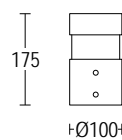

1456.LVX.T.-- 8W LED 3000K 720lm
220-240V 50/60hz
alimentatore incluso *LED driver integral*

1456.BRX.T.-- 12W LED 3000K 1700lm
220-240V 50/60hz
alimentatore incluso *LED driver integral*

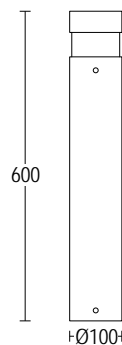

1445.LVX.T.-- 8W LED 3000K 720lm
220-240V 50/60hz
alimentatore incluso *LED driver integral*

1445.BRX.T.-- 12W LED 3000K 1700lm
220-240V 50/60hz
alimentatore incluso *LED driver integral*

1445.CGX.T.-- 26W LED 3000K 3165lm
220-240V 50/60hz
alimentatore incluso *LED driver integral*

- .05** grigio antracite
anthracite grey
- .13** grigio chiaro
light grey

ACCESSORI ACCESSORIES



251
codice base di ancoraggio
plated steel anchorage code



204
Connettore rapido IP68
IP 68 fast connector



279
Connettore per
cablaggio in cascata IP 68
*IP 68 connector
for through wiring*

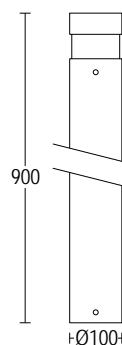

1446.LVX.T.-- 8W LED 3000K 720lm
220-240V 50/60hz
alimentatore incluso *LED driver integral*

1446.BRX.T.-- 12W LED 3000K 1700lm
220-240V 50/60hz
alimentatore incluso *LED driver integral*

1446.CGX.T.-- 26W LED 3000K 3165lm
220-240V 50/60hz
alimentatore incluso *LED driver integral*

TONDO



TONDO 360°

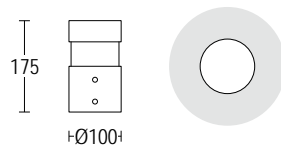

1457.LVX.T.-- 8W LED 3000K 720lm
220-240V 50/60hz
alimentatore incluso *LED driver integral*

1457.BRX.T.-- 12W LED 3000K 1700lm
220-240V 50/60hz
alimentatore incluso *LED driver integral*

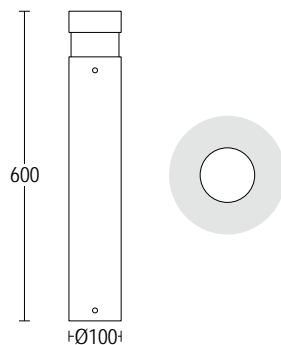

1372.LVX.T.-- 8W LED 3000K 720lm
220-240V 50/60hz
alimentatore incluso *LED driver integral*

1372.BRX.T.-- 12W LED 3000K 1700lm
220-240V 50/60hz
alimentatore incluso *LED driver integral*

1372.CGX.T.-- 26W LED 3000K 3165lm
220-240V 50/60hz
alimentatore incluso *LED driver integral*

- .05** grigio antracite
anthracite grey
- .13** grigio chiaro
light grey

ACCESSORI ACCESSORIES



251
codice base di ancoraggio
plated steel anchorage code



204
Connettore rapido IP68
IP 68 fast connector



279
Connettore per
cablaggio in cascata IP 68
*IP 68 connector
for through wiring*

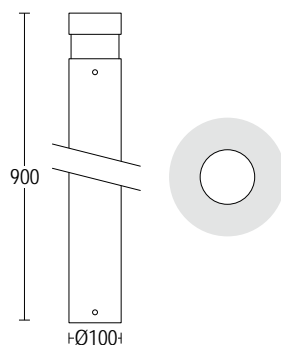

1375.LVX.T.-- 8W LED 3000K 720lm
220-240V 50/60hz
alimentatore incluso *LED driver integral*

1375.BRX.T.-- 12W LED 3000K 1700lm
220-240V 50/60hz
alimentatore incluso *LED driver integral*

1375.CGX.T.-- 26W LED 3000K 3165lm
220-240V 50/60hz
alimentatore incluso *LED driver integral*

MINIQUADRO



Bollard dal design minimale. Altamente resistente all'ossidazione, grazie alla sua realizzazione in alluminio pressofuso, si presta particolarmente all'illuminazione di vialetti, camminamenti e aiuole. Versatile nel suo utilizzo grazie alle due emissioni a 360° o 180°.

Bollard made in extruded aluminium which is highly resistant to oxidation and particularly suitable for the lighting of paths, walkways and gardens.

MINIQUADRO 180°

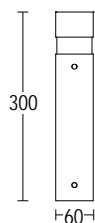
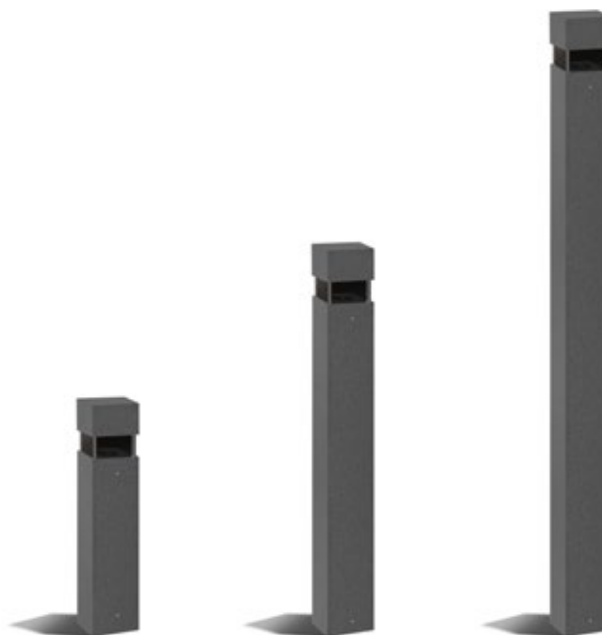
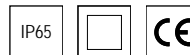

1256.BRX.T.-- 12W LED 3000K 1800lm
220-240V 50/60hz
alimentatore incluso *LED driver integral*



1257.BRX.T.-- 12W LED 3000K 1800lm
220-240V 50/60hz
alimentatore incluso *LED driver integral*

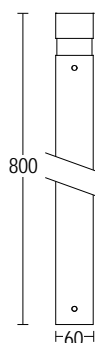

1258.BRX.T.-- 12W LED 3000K 1800lm
220-240V 50/60hz
alimentatore incluso *LED driver integral*

- .05** grigio antracite
anthracite grey
- .13** grigio chiaro
light grey

ACCESSORI ACCESSORIES



272
codice base di ancoraggio
plated steel anchorage code



204
Connettore rapido IP68
IP 68 fast connector



279
Connettore per
cablaggio in cascata IP 68
*IP 68 connector
for through wiring*

MINIQUADRO



MINIQUADRO 360°

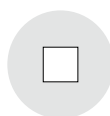
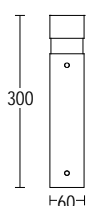
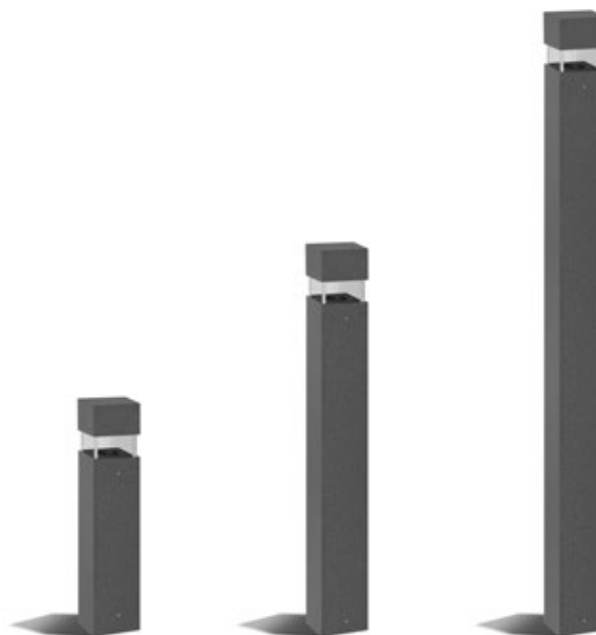
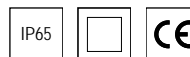

1259.BRX.T.-- 12W LED 3000K 1800lm
220-240V 50/60hz
alimentatore incluso *LED driver integral*

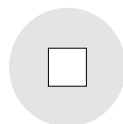

1260.BRX.T.-- 12W LED 3000K 1800lm
220-240V 50/60hz
alimentatore incluso *LED driver integral*

- .05** grigio antracite
anthracite grey
- .13** grigio chiaro
light grey

ACCESSORI ACCESSORIES



272
codice base di ancoraggio
plated steel anchorage code



204
Connettore rapido IP68
IP 68 fast connector



279
Connettore per
cablaggio in cascata IP 68
*IP 68 connector
for through wiring*

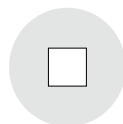
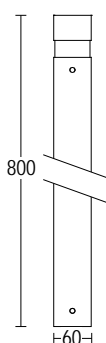

1261.BRX.T.-- 12W LED 3000K 1800lm
220-240V 50/60hz
alimentatore incluso *LED driver integral*

QUADRO 180°

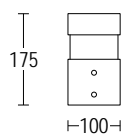
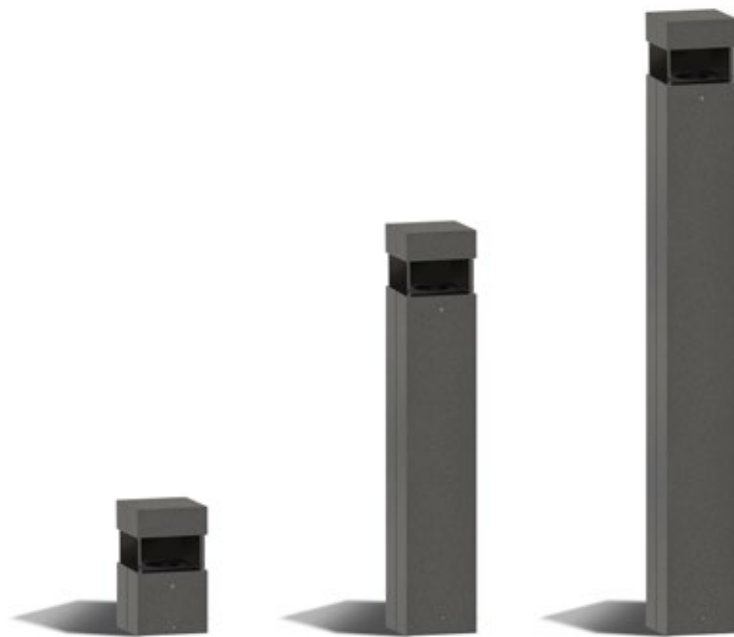

1459.LVX.T.-- 8W LED 3000K 720lm
220-240V 50/60hz ⚡
alimentatore incluso *LED driver integral*

1459.BRX.T.-- 12W LED 3000K 1700lm
220-240V 50/60hz ⚡
alimentatore incluso *LED driver integral*

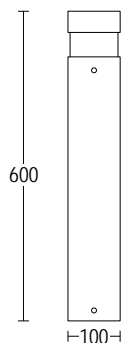

1451.LVX.T.-- 8W LED 3000K 720lm
220-240V 50/60hz ⚡
alimentatore incluso *LED driver integral*

1451.BRX.T.-- 12W LED 3000K 1700lm
220-240V 50/60hz ⚡
alimentatore incluso *LED driver integral*

1451.CGX.T.-- 26W LED 3000K 3165lm
220-240V 50/60hz ⚡
alimentatore incluso *LED driver integral*

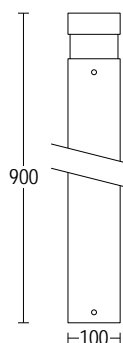

1450.LVX.T.-- 8W LED 3000K 720lm
220-240V 50/60hz ⚡
alimentatore incluso *LED driver integral*

1450.BRX.T.-- 12W LED 3000K 1700lm
220-240V 50/60hz ⚡
alimentatore incluso *LED driver integral*

1450.CGX.T.-- 26W LED 3000K 3165lm
220-240V 50/60hz ⚡
alimentatore incluso *LED driver integral*

- .05** grigio antracite
anthracite grey
- .13** grigio chiaro
light grey

ACCESSORI ACCESSORIES



251
codice base di ancoraggio
plated steel anchorage code



204
Connettore rapido IP68
IP 68 fast connector



279
Connettore per
cablaggio in cascata IP 68
*IP 68 connector
for through wiring*

QUADRO 360°

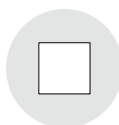
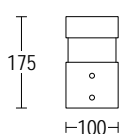
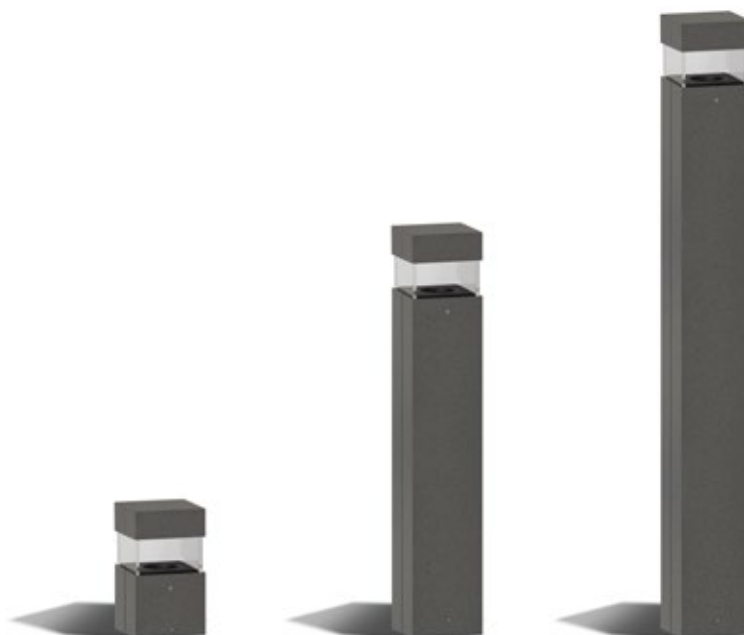

1460.LVX.T.-- 8W LED 3000K 720lm
220-240V 50/60hz
alimentatore incluso *LED driver integral*

1460.BRX.T.-- 12W LED 3000K 1700lm
220-240V 50/60hz
alimentatore incluso *LED driver integral*

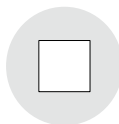
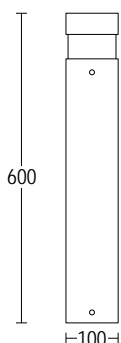

1370.LVX.T.-- 8W LED 3000K 720lm
220-240V 50/60hz
alimentatore incluso *LED driver integral*

1370.BRX.T.-- 12W LED 3000K 1700lm
220-240V 50/60hz
alimentatore incluso *LED driver integral*

1370.CGX.T.-- 26W LED 3000K 3165lm
220-240V 50/60hz
alimentatore incluso *LED driver integral*

- .05** grigio antracite
anthracite grey
- .13** grigio chiaro
light grey

ACCESSORI ACCESSORIES



251
codice base di ancoraggio
plated steel anchorage code



204
Connettore rapido IP68
IP 68 fast connector



279
Connettore per
cablaggio in cascata IP 68
*IP 68 connector
for through wiring*

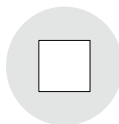
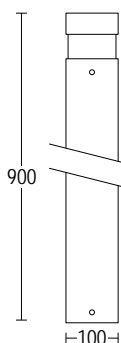

1369.LVX.T.-- 8W LED 3000K 720lm
220-240V 50/60hz
alimentatore incluso *LED driver integral*

1369.BRX.T.-- 12W LED 3000K 1700lm
220-240V 50/60hz
alimentatore incluso *LED driver integral*

1369.CGX.T.-- 26W LED 3000K 3165lm
220-240V 50/60hz
alimentatore incluso *LED driver integral*

RETTANGOLO



photo by: Germano Borrelli



Bollard dal design minimale. Altamente resistente all'ossidazione, grazie alla sua realizzazione in alluminio pressofuso, si presta particolarmente all'illuminazione di vialetti, camminamenti e aiuole.

Bollard made in extruded aluminium which is highly resistant to oxidation and particularly suitable for the lighting of paths, walkways and gardens.

RETTANGOLO

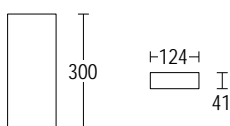

1421.ETX.O.-- 4,2 W Led 3000 K 360 lm
110° ^
220-240 V 50/60 HZ
alimentatore incluso *led driver integral*

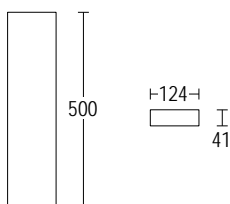

1422.AHX.O.-- 7 W Led 3000 K 600 lm
110° ^
220-240 V 50/60 HZ
alimentatore incluso *led driver integral*

- .05** grigio antracite
anthracite grey
- .13** grigio chiaro
light grey

ACCESSORI ACCESSORIES



251
codice base di ancoraggio
plated steel anchorage code



204
Connettore rapido IP68
IP 68 fast connector



279
Connettore per
cablaggio in cascata IP 68
*IP 68 connector
for through wiring*

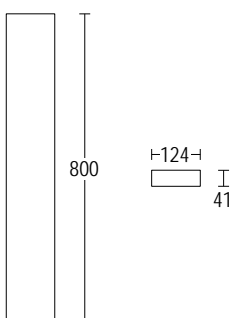

1423.CAX.O.-- 11 W Led 3000 K 960 lm
110° ^
220-240 V 50/60 HZ
alimentatore incluso *led driver integral*

COMPATTO BOLLARD



Bollard asimmetrico dal design minimale. Altamente resistente all'ossidazione, grazie alla sua realizzazione in alluminio pressofuso, si presta particolarmente all'illuminazione di vialetti, camminamenti e aiuole.

Bollard made in extruded aluminium which is highly resistant to oxidation and particularly suitable for the lighting of paths, walkways and gardens.



COMPATTO BOLLARD

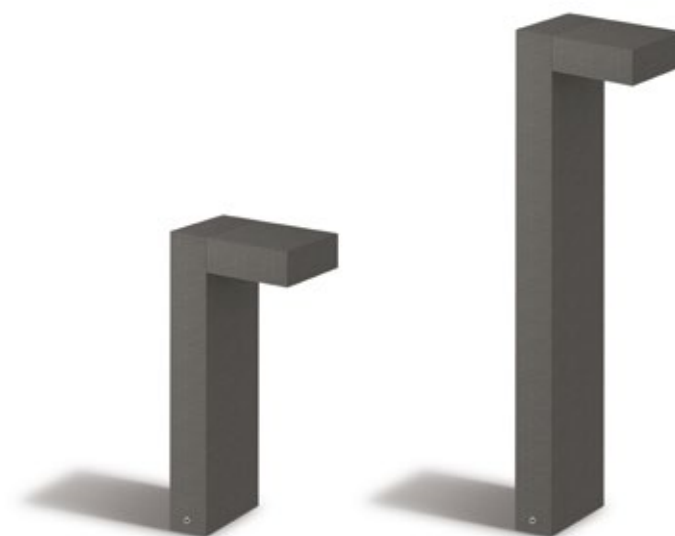

- .05** grigio antracite
anthracite grey
- .13** grigio chiaro
light grey

ACCESSORI ACCESSORIES



274
codice base di ancoraggio
plated steel anchorage code



204
Connettore rapido IP68
IP 68 fast connector



279
Connettore per
cablaggio in cascata IP 68
*IP 68 connector
for through wiring*

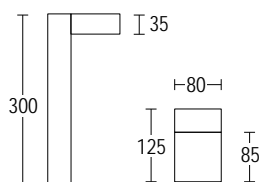

1426.CAFT.-- 13W LED 3000K 1800lm
180° \wedge
220-240V 50/60hz
alimentatore incluso *LED driver integral*

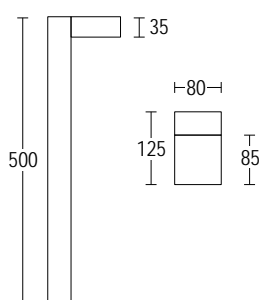

1427.CAFT.-- 13W LED 3000K 1800lm
180° \wedge
220-240V 50/60hz
alimentatore incluso *LED driver integral*

POLVERTI FLAT



Bollard asimmetrico dal design minimale. Altamente resistente all'ossidazione, grazie alla sua realizzazione in alluminio pressofuso, si presta particolarmente all'illuminazione di vialetti, camminamenti e aiuole.

Asymmetric bollard with an minimal design and particularly suitable for the lighting of paths, walkways and gardens.

POLVERTI FLAT



- .05** grigio antracite
anthracite grey
- .13** grigio chiaro
light grey

ACCESSORI ACCESSORIES



274
codice base di ancoraggio
plated steel anchorage code



204
Connettore rapido IP68
IP 68 fast connector



279
Connettore per
cablaggio in cascata IP 68
*IP 68 connector
for through wiring*

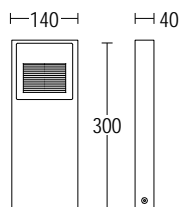

1149.ETX.T.-- 3,5W LED 3000 K 410lm
asym ^
220-240V 50/60hz
alimentatore incluso *LED driver integral*

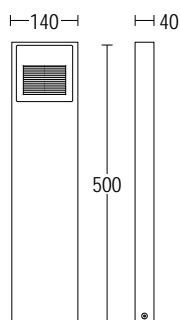

1139.ETX.T.-- 3,5W LED 3000 K 410lm
asym ^
220-240V 50/60hz
alimentatore incluso *LED driver integral*

MICROBIVIO FLOOR



Bollard dal design minimale, grazie alla sua caratteristica installazione a pavimento genera un'illuminazione radente. Altamente resistente all'ossidazione, grazie alla sua realizzazione in alluminio pressofuso, si presta particolarmente all'illuminazione di vialetti, camminamenti e aiuole. Versatile nel suo utilizzo grazie al sistema ottico ad uno o due fasci.

Bollard made in die-cast aluminum which is highly resistant to oxidation and particularly suitable for the lighting of paths, walkways and gardens.

MINIBIVIO FLOOR

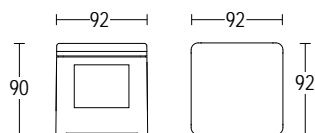

1196.AHF.T.-- 7W LED 3000K 1045lm
 32° ^
 220-240 V 50/60 HZ
 alimentatore incluso *LED driver integral*

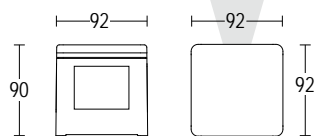

1197.DDF.T.-- 7W LED 3000K 2 x 545lm
 32° ^
 220-240 V 50/60 HZ
 alimentatore incluso *LED driver integral*

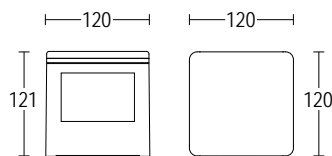

1198.BRF.T.-- 13W LED 3000K 1800lm
 36° ^
 220-240 V 50/60 HZ
 alimentatore incluso *LED driver integral*

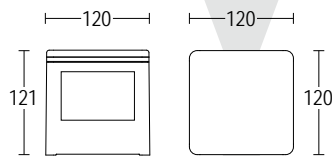

1199.ERF.T.-- 13W LED 3000K 2 x 900lm
 36° ^
 220-240 V 50/60 HZ
 alimentatore incluso *LED driver integral*

- **.05** grigio antracite
anthracite grey
- **.13** grigio chiaro
light grey

ACCESSORI ACCESSORIES



Base di ancoraggio
Plated steel anchorage

684 Microbivio
685 Minibivio



204
Connettore rapido IP68
IP 68 fast connector

**INDOOR
HOME LIGHTING**

LUCITALIA

ZERO 0

design Francesco Brivio



Finiture speciali
Special finishes

Lampada da parete a luce indiretta dalla forma geometrica e minimale. Grazie alla sua eleganza essenziale trova la sua perfetta collocazione in contesti residenziali quali ingressi, zone passaggio e piccole camere.

Wall lamp with an indirect light emission and a simple and geometric shape. Suitable for lighting residential spaces. It is perfectly positioned in entrances, corridors and small rooms.



Colore standard 1 settimana
Standard color 1 week

 **.01** Bianco
White (matt)

Colore su richiesta 2 settimane
Upon request color 2 weeks

 **.19** Grigio argento
Silver grey (matt)

 **.22** Nero
Black (matt)

 **.45** Ruggine
Rust

Colore su richiesta 4/6 settimane
Upon request color 4/6 weeks

 **.39** Effetto nickel
Nickel effect

 **.56** Effetto oro spazzolato
Brushed gold effect

 **.51** Effetto fibra di carbonio
Carbon fiber effect

 **.30** Effetto rovere sbiancato
Whitened oak effect

 **.32** Effetto noce
Walnut effect

 **.33** Effetto wengè
Wengè effect

 **.43** Effetto cemento
Concrete effect

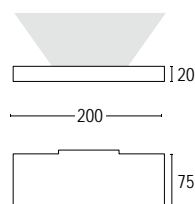

20220.--.31.T 15W LED 3000K 1500lm
120°  dimmerabile TAGLIO DI FASE *dimmmable TRAILING EDGE*
220-240V 50/60hz

ZERO 1

design Francesco Brivio

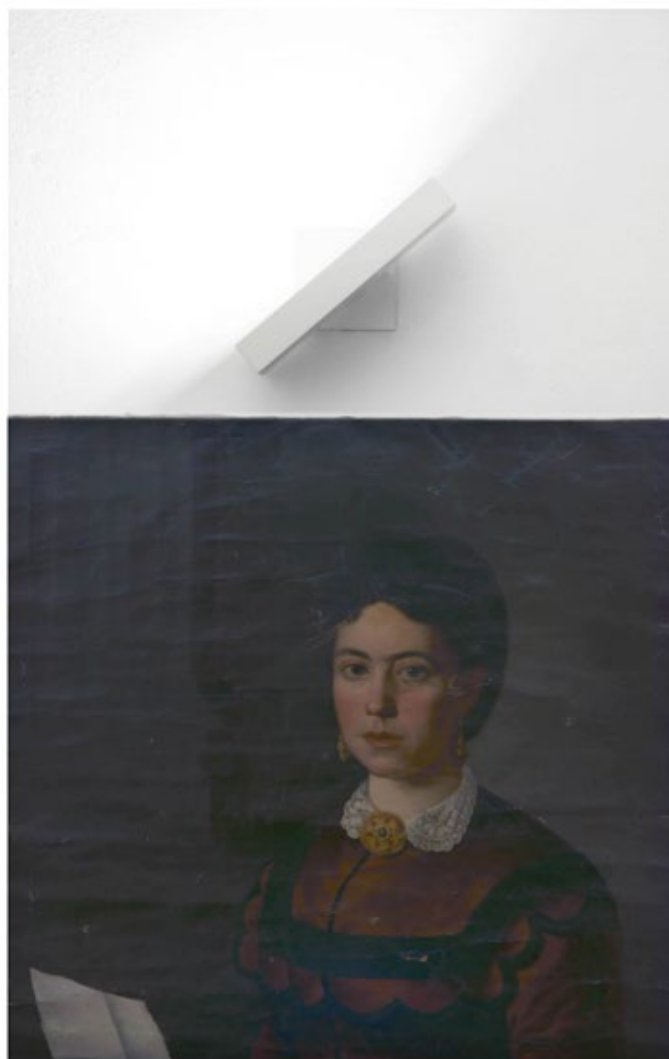

Lampada da parete a luce indiretta dalla forma geometrica e minimale. Grazie alla sua eleganza essenziale trova la sua perfetta collocazione in ambiti sia commerciali che residenziali, impreziosendo i diversi ambienti grazie alle finiture metalliche e materiche. L'ottica asimmetrica racchiusa all'interno del corpo illuminante rende l'apparecchio particolarmente indicato per l'enfatizzazione di elementi architettonici quali volte o archi e la staffa da cui è sorretta consente l'orientabilità del prodotto di 180° su entrambi i lati.

Wall lamp with an indirect light emission and a simple and geometric shape. Suitable for lighting commercial and residential spaces. Thanks to its essential elegance, it is perfectly positioned in both commercial and residential spaces, enriching the different environments thanks to metallic and material finishes. Available with asymmetrical optics and also, it is fully adjustable (180°) on both sides.



Colore standard 1 settimana
Standard color 1 week

 **.01** Bianco
White (matt)

Colore su richiesta 2 settimane
Upon request color 2 weeks

 **.19** Grigio argento
Silver grey (matt)

 **.22** Nero
Black (matt)

 **.45** Ruggine
Rust

Colore su richiesta 4/6 settimane
Upon request color 4/6 weeks

 **.39** Effetto nickel
Nickel effect

 **.56** Effetto oro spazzolato
Brushed gold effect

 **.51** Effetto fibra di carbonio
Carbon fiber effect

 **.30** Effetto rovere sbiancato
Whitened oak effect

 **.32** Effetto noce
Walnut effect

 **.33** Effetto wengè
Wengè effect

 **.43** Effetto cemento
Concrete effect

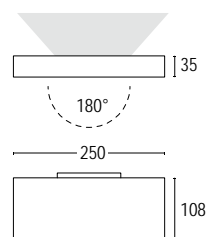

24301.--.31 17W LED 3000K 2600lm
120° \wedge
220-240V 50/60hz
alimentatore incluso LED driver integral

24304.--.31.P 26W LED 3000K 3600lm
120° \wedge dimmerabile dimmable PUSH
220-240V 50/60hz
alimentatore incluso LED driver integral

ZERO KID

design Francesco Brivio



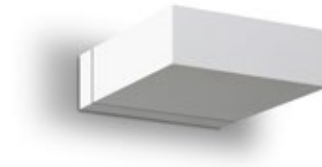

Colore standard 1 settimana
Standard color 1 week

 **.01** Bianco
White (matt)

Colore su richiesta 2 settimane
Upon request color 2 weeks

 **.19** Grigio argento
Silver grey (matt)

 **.22** Nero
Black (matt)

 **.45** Ruggine
Rust

Colore su richiesta 4/6 settimane
Upon request color 4/6 weeks

 **.39** Effetto nickel
Nickel effect

 **.56** Effetto oro spazzolato
Brushed gold effect

 **.51** Effetto fibra di carbonio
Carbon fiber effect

 **.30** Effetto rovere sbiancato
Whitened oak effect

 **.32** Effetto noce
Walnut effect

 **.33** Effetto wengè
Wengè effect

 **.43** Effetto cemento
Concrete effect

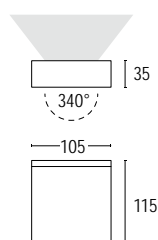

20202.--.31 12W LED 3000K 1130lm
120° 
220-240V 50/60hz
alimentatore incluso *LED driver integral*

ZERO 1 VERTI

design Francesco Brivio



Lampada da parete mono o bi-emissione dalla forma semplice e geometrica. L'apparecchio trova la sua collocazione ideale negli spazi residenziali e commerciali.

Fixture available with single or double emission both with a simple and geometrical shape. Suitable for residential and commercial lighting spaces



Colore standard 1 settimana
Standard color 1 week

 **.01** Bianco
White (matt)

Colore su richiesta 2 settimane
Upon request color 2 weeks

 **.19** Grigio argento
Silver grey (matt)

 **.22** Nero
Black (matt)

 **.45** Ruggine
Rust

Colore su richiesta 4/6 settimane
Upon request color 4/6 weeks

 **.39** Effetto nickel
Nickel effect

 **.56** Effetto oro spazzolato
Brushed gold effect

 **.51** Effetto fibra di carbonio
Carbon fiber effect

 **.30** Effetto rovere sbiancato
Whitened oak effect

 **.32** Effetto noce
Walnut effect

 **.33** Effetto wengè
Wengè effect

 **.43** Effetto cemento
Concrete effect

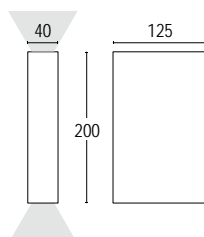
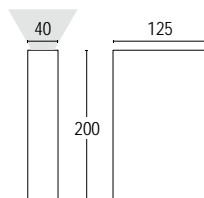

24501.--.31 12W LED 3000K 1800lm
120° 
220-240V 50/60hz
alimentatore incluso LED driver integral

24503.--.31 16W LED 3000K 2 x 1300lm
120° 
220-240V 50/60hz
alimentatore incluso LED driver integral

ADAM W

design Hikaru Mori

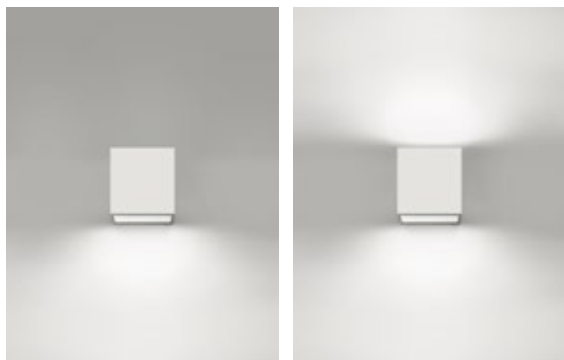

Lampada da parete mono o bi-emissione dalla forma semplice e geometrica. L'apparecchio trova la sua collocazione ideale negli spazi residenziali e commerciali. La luce emessa da questo apparecchio diretta ed indiretta, morbida e diffusa, grazie al vetro opalino garantisce l'assenza di abbagliamento.

Simple geometric shaped fixture available with single or double emission. Suitable for residential and commercial spaces. Glare free light distribution is soft and diffused.





Colore standard 1 settimana
Standard color 1 week

 **.01** Bianco
White (matt)

Colore su richiesta 2 settimane
Upon request color 2 weeks

 **.19** Grigio argento
Silver grey (matt)

 **.22** Nero
Black (matt)

 **.45** Ruggine
Rust

Colore su richiesta 4/6 settimane
Upon request color 4/6 weeks

 **.51** Effetto fibra di carbonio
Carbon fiber effect

 **.30** Effetto rovere sbiancato
Whitened oak effect

 **.32** Effetto noce
Walnut effect

 **.33** Effetto wengè
Wengè effect

 **.43** Effetto cemento
Concrete effect

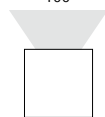
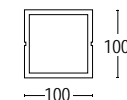

20367.--.31.T 9W LED 3000K 780lm
120° \wedge dimmerabile TAGLIO DI FASE *dimmable TRAILING EDGE*
220-240V 50/60hz
alimentatore incluso *LED driver integral*

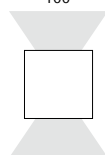
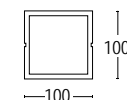

20365.--.31.T 18W LED 3000K 2 x 780lm
120° \wedge dimmerabile TAGLIO DI FASE *dimmable TRAILING EDGE*
220-240V 50/60hz
alimentatore incluso *LED driver integral*

CUFFLINK

design Serge & Robert Cornelissen



Lampada da parete dalla forma semplice e minimalista dalla doppia emissione luminosa morbida e diffusa. Trova la sua applicazione ideale nell'illuminazione di piccoli spazi residenziali.

Indirect emission wall lamp with simple and geometric shape. The light distribution is soft and diffused and is particularly suitable for lighting small residential areas.



Colore standard 1 settimana

Standard color 1 week

 **.01** Bianco
White (matt)

Colore su richiesta 2 settimane

Upon request color 2 weeks

 **.19** Grigio argento
Silver grey (matt)

 **.22** Nero
Black (matt)

 **.45** Ruggine
Rust

Colore su richiesta 4/6 settimane

Upon request color 4/6 weeks

 **.39** Effetto nickel
Nickel effect

 **.56** Effetto oro spazzolato
Brushed gold effect

 **.51** Effetto fibra di carbonio
Carbon fiber effect

 **.30** Effetto rovere sbiancato
Whitened oak effect

 **.32** Effetto noce
Walnut effect

 **.33** Effetto wengè
Wengè effect

 **.43** Effetto cemento
Concrete effect

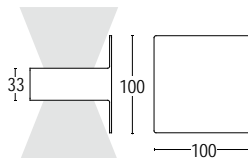

25301.--.31 10W LED 3000 K 2 x 410lm
120° 
220-240V 50/60hz
alimentatore incluso *LED driver integral*

CAGE

design Serge & Robert Cornelissen



photo by: Germano Borrelli

Lampada da parete a luce diretta o indiretta, ideale per creare effetti scenografici ed illuminare passaggi e corridoi con una luce morbida e soffusa. Trova la sua applicazione ideale in ambienti residenziali, spazi ricettivi o uffici.

Wall lamp with indirect light distribution creates scenic effects while lighting passageways and hallways. Cage is particularly suitable for application such as residential environments, receptive spaces and offices.

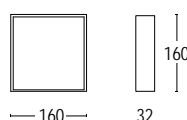

25201.--.31 4W LED 3000K 640lm
 120° \wedge
 220-240V 50/60hz
 alimentatore incluso *LED driver integral*

Colore standard 1 settimana
Standard color 1 week

 **.01** Bianco
White (matt)

Colore su richiesta 2 settimane
Upon request color 2 weeks

 **.19** Grigio argento
Silver grey (matt)

 **.22** Nero
Black (matt)

 **.45** Ruggine
Rust

Colore su richiesta 4/6 settimane
Upon request color 4/6 weeks

 **.27** Nero - oro
Black - gold

 **.25** Bianco - oro
White - gold

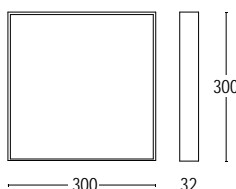

25202.--.31 8 W LED 3000 K 1250 lm
 120° \wedge
 220-240V 50/60hz
 alimentatore incluso *LED driver integral*

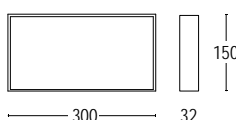

25203.--.31 8 W LED 3000 K 1250 lm
 120° \wedge
 220-240V 50/60hz
 alimentatore incluso *LED driver integral*

ZERO AMICA

design Francesco Brivio



Lampada da parete a luce diretta o indiretta, ideale per creare effetti scenografici ed illuminare passaggi e corridoi con una luce morbida e soffusa. Trova la sua applicazione ideale in ambienti residenziali, spazi ricettivi o uffici.

Wall lamp with indirect light distribution creates scenic effects while lighting passageways and hallways. Cage is particularly suitable for application such as residential environments, receptive spaces and offices

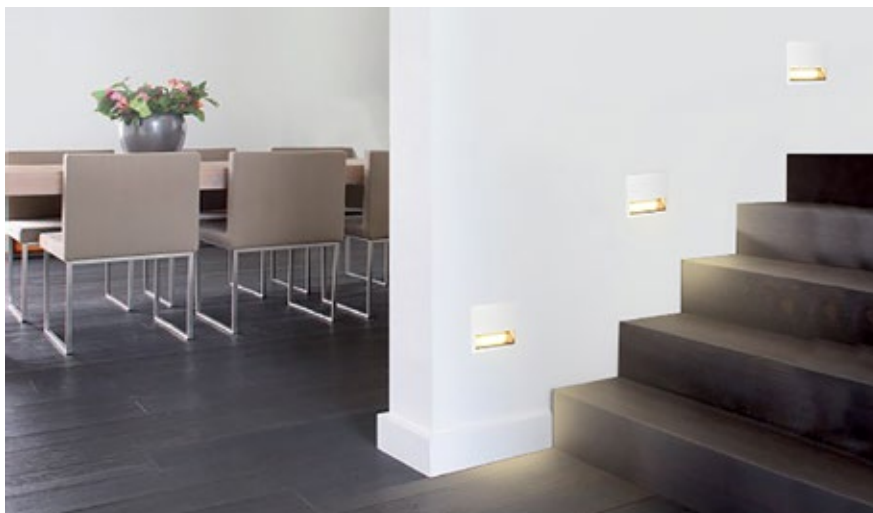



Colore standard 1 settimana
Standard color 1 week

○ .01 Riflettore standard
Standard reflector

Colore su richiesta 4/6 settimane
Upon request color 4/6 weeks

● .56 Riflettore oro
Gold reflector

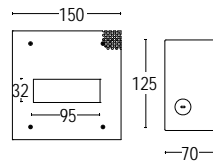

21402.--.31 3W LED 3000K 400lm
120° ^
max 350mA DC
alimentatore remoto SELV non incluso
remote SELV LED driver not included

Colore standard 1 settimana
Standard color 1 week

○ .01 Bianco
White (matt)

Colore su richiesta 2 settimane
Upon request color 2 weeks

● .19 Grigio argento
Silver grey (matt)

● .22 Nero
Black (matt)

● .45 Ruggine
Rust

Colore su richiesta 4/6 settimane
Upon request color 4/6 weeks

● .27 Corpo nero - riflettore oro
Black body - gold reflector

● .25 Corpo bianco - riflettore oro
White body - gold reflector

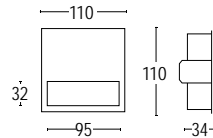

21401.--.31 3W LED 3000K 400lm
120° ^
220-240V 50/60hz
alimentatore incluso LED driver integral

ACCESSORIES



22001
Alimentatore 350 mA
1 per 1-3 Zero amica 3W
LED driver 350 mA
1 for 1-3 Zero amica 3W

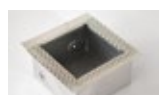

21404
Controcassa per muratura in
cemento o laterizio
Concrete recessed box

ZERO AMICA R GLASS



Riflettore standard
Stanfard reflector



Riflettore oro
Gold reflector

ZERO AMICA R GLASS



Colore standard 1 settimana

Standard color 1 week

○ **.01** Vetro bianco
White glass

Colore su richiesta 2 settimane

Upon request color 2 weeks

● **.22** Vetro nero
Black glass

Colore speciale su richiesta 4/6 settimane

Upon request color 4/6 weeks

● **.27** Vetro nero - riflettore oro
Black glass - gold reflector

● **.25** Vetro bianco - riflettore oro
White glass - gold reflector

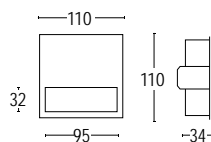

Versione vetro
Glass version

21406.--.31 3W LED 3000K 400lm
120° ^
220-240V 50/60hz
alimentatore incluso *LED driver integral*

ACCESSORIES



21404
Controcassa per muratura in
cemento o laterizio
Concrete recessed box

BOX C

Apparecchio a soffitto per l'illuminazione di spazi residenziali e commerciali. L'apparecchio è dotato di un sistema che, oltre a garantire un comfort visivo ottimale, consente l'orientabilità delle ottiche oltre i 25° al fine di ottenere un effetto wall washer. Disponibili due tipi di ottiche, a fascio medio e diffuso, e grazie a un'ampia gamma di finiture, metalliche e materiche, consente una versatilità totale in ogni contesto.

Ceiling surface mounted downlight fixture designed for light commercial and residential spaces. The item is equipped with a system that, in addition to providing optimum visual comfort, allows the optics to be more than 25° in order to achieve a wall washer effect. Different heights and various lighting beams are available.

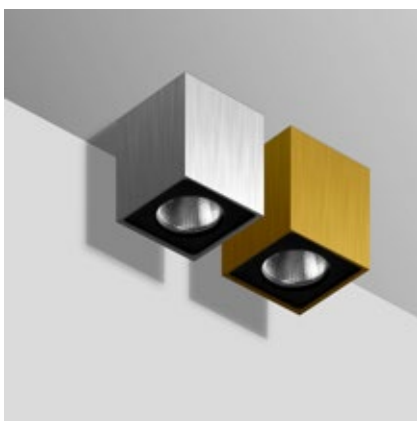

Finiture speciali
Special finishes



Colore standard 1 settimana
Standard color 1 week

○ .01 Bianco
White (matt)

Colore su richiesta 2 settimane
Upon request color 2 weeks

● .19 Grigio argento
Silver grey (matt)

● .22 Nero
Black (matt)

● .45 Ruggine
Rust

Colore su richiesta 4/6 settimane
Upon request color 4/6 weeks

● .39 Effetto nickel
Nickel effect

● .56 Effetto oro spazzolato
Brushed gold effect

● .51 Effetto fibra di carbonio
Carbon fiber effect

● .30 Effetto rovere sbiancato
Whitened oak effect

● .32 Effetto noce
Walnut effect

● .33 Effetto wengè
Wengè effect

● .43 Effetto cemento
Concrete effect

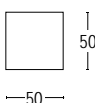
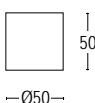

25140.--.31.T 4,5W LED 3000K 400lm
60° ^ dimmerabile TAGLIO DI FASE dimmable TRAILING EDGE
220-240V 50/60hz

25150.--.31.T 4,5W LED 3000K 400lm
60° ^ dimmerabile TAGLIO DI FASE dimmable TRAILING EDGE
220-240V 50/60hz

BOX 1C



20382.79
Diffusore acidato
Acid diffuser



20381.00
Schermo antiabbagliamento
a nido d'ape
Honeycomb anti-dazzle screen



20988.01
Vetro bianco
White glass



20988.22
Vetro nero
Black glass



20983.01
Vetro bianco
White glass



20983.22
Vetro nero
Black glass



20984.01
Vetro bianco
White glass



20984.22
Vetro nero
Black glass

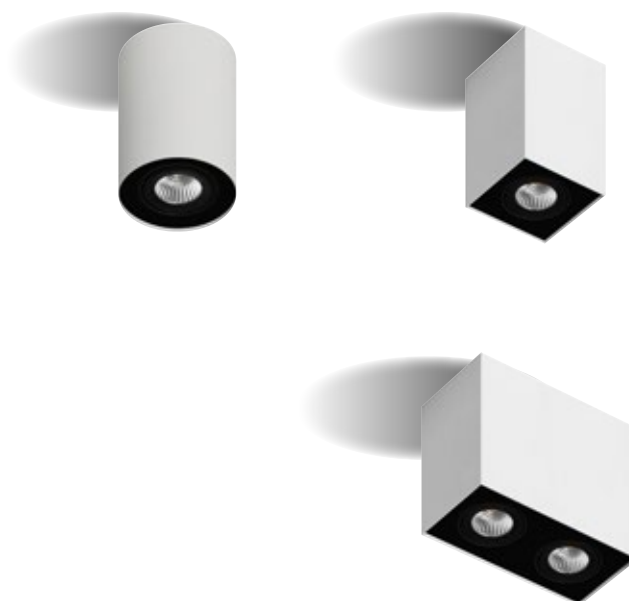

Colore standard 1 settimana
Standard color 1 week

 **.01** Bianco
White (matt)

Colore su richiesta 2 settimane
Upon request color 2 weeks

 **.19** Grigio argento
Silver grey (matt)

 **.22** Nero
Black (matt)

 **.45** Ruggine
Rust

Colore su richiesta 4/6 settimane
Upon request color 4/6 weeks

 **.51** Effetto fibra di carbonio
Carbon fiber effect

 **.30** Effetto rovere sbiancato
Whitened oak effect

 **.32** Effetto noce
Walnut effect

 **.33** Effetto wengé
Wengé effect

 **.43** Effetto cemento
Concrete effect

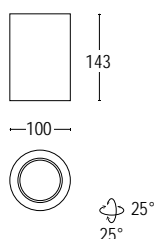

20950.--.31 10W LED 3000K 1250lm
40° 
220-240V 50/60hz
alimentatore incluso LED driver integral

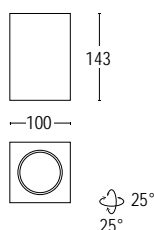

20901.--.31 10W LED 3000K 1250lm
40° 
220-240V 50/60hz
alimentatore incluso LED driver integral

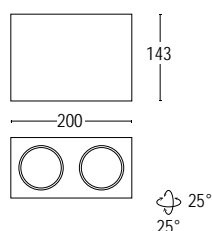

20902.--.31 20W LED 3000K 2 x 1250lm
40° 
220-240V 50/60hz
alimentatore incluso LED driver integral

STELO C

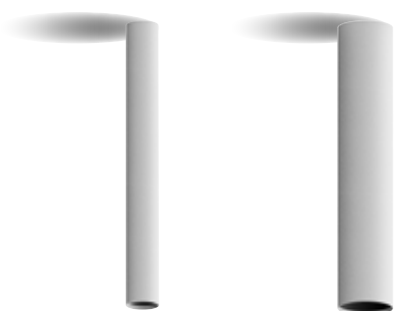

STELO 0

STELO 1

Lampada a soffitto dal design essenziale a luce diretta. Regolarità e semplicità sono le parole chiave di questo apparecchio. La purezza incontaminata del corpo illuminante si presta perfettamente a creare delle composizioni con questa lampada, grazie alle diverse lunghezze e dimensioni in cui essa è disponibile. Le molteplici finiture materiche disponibili lo rendono inoltre versatile in diversi contesti; Stelo diventa infatti un elemento dal design raffinato per sale da pranzo, spazi commerciali, o luoghi d'accoglienza. Per una maggiore versatilità l'apparecchio dispone inoltre di due tipologie di ottiche: concentrante o diffusa, garantendo la perfetta illuminazione degli ambienti in cui viene inserito.

Ceiling luminaire with essential design and direct light emission. Its simple design allows for various installations including residential spaces, contract environments and executive headquarters. The uncontaminated purity of the design lends perfectly to creating compositions with multiple lamps, thanks to the various lengths and sizes it is available in. Concentrated or diffused optics available, furthering its versatility.



Finiture speciali
Special finishes



23102.--.31 6W LED 3000 K 800lm
30° ^
220-240V 50/60hz
alimentatore incluso *LED driver integral*

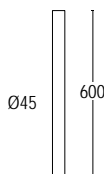

23104.--.31 6W LED 3000K 800lm
30° ^
220-240V 50/60hz
alimentatore incluso *LED driver integral*

Colore standard 1 settimana
Standard color 1 week

 **.01** Bianco
White (matt)

Colore su richiesta 2 settimane
Upon request color 2 weeks

 **.19** Grigio argento
Silver grey (matt)

 **.22** Nero
Black (matt)

 **.45** Ruggine
Rust

Colore su richiesta 4/6 settimane
Upon request color 4/6 weeks

 **.27** Nero - oro
Black - gold

 **.25** Bianco - oro
White - gold

 **.72** Nero - rosso
Black - red

 **.71** Bianco - rosso
White - red



23111.--.31 12W LED 3000K 1800lm
30° ^
220-240V 50/60hz
alimentatore incluso *LED driver integral*

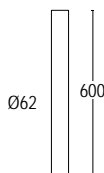

23112.--.31 12W LED 3000K 1800lm
30° ^
220-240V 50/60hz
alimentatore incluso *LED driver integral*

DRUM C



Lampada a plafone con emissione di luce diretta. La perfezione geometrica conferita dalla circolarità di questo apparecchio, unita alla semplicità del corpo illuminante consentono varie possibilità di installazione: singola in contesti residenziali, modulare in luoghi di accoglienza quali hall di alberghi o ampi spazi commerciali. Il comfort visivo generato da questo apparecchio è garantito dalla presenza del diffusore opalino che chiude il corpo della lampada, emettendo una luce morbida ma dalle elevate prestazioni. Le molteplici finiture materiche disponibili lo rendono versatile in diversi contesti.

Ceiling luminaire with direct light emission. The geometric perfection of the design along with its simple lines allow for various installations including residential spaces, contract environments and executive headquarters. Opal diffuser delivers high quality diffused light.

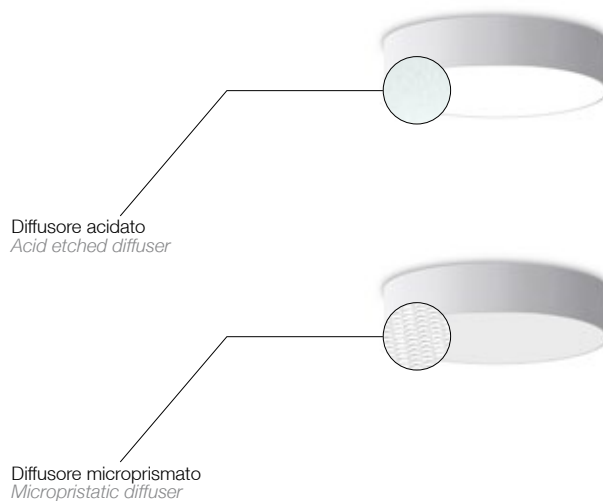

DRUM C

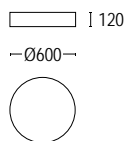

26701.--.31 30W LED 3000K 4800lm
 110° ^
 220-240V 50/60hz
 alimentatore incluso *LED driver integra*
 diffusore acidato *acid etched diffuser*

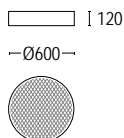

26702.--.31 30W LED 3000K 4800lm
 90° ^
 220-240V 50/60hz
 alimentatore incluso *LED driver integral*
 diffusore microprismato *microprismatic diffuser*

Colore standard 1 settimana
Standard color 1 week

○ **.01** Bianco
White (matt)

Colore su richiesta 2 settimane
Upon request color 2 weeks

● **.19** Grigio argento
Silver grey (matt)

● **.22** Nero
Black (matt)

● **.45** Ruggine
Rust

Colore su richiesta 4/6 settimane
Upon request color 4/6 weeks

● **.51** Effetto fibra di carbonio
Carbon fiber effect

● **.30** Effetto rovere sbiancato
Whitened oak effect

● **.32** Effetto noce
Walnut effect

● **.33** Effetto wengè
Wengè effect

● **.43** Effetto cemento
Concrete effect

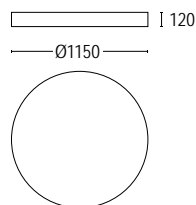

26710.--.31 108W LED 3000K 18000lm
 110° ^
 220-240V 50/60hz
 alimentatore incluso *LED driver integral*
 diffusore acidato *acid etched diffuser*

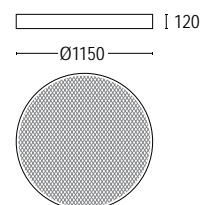

26711.--.31 108W LED 3000K 18000lm
 90° ^
 220-240V 50/60hz
 alimentatore incluso *LED driver integral*
 diffusore microprismato *microprismatic diffuser*

COMFORT



Apparecchio da incasso a soffitto, trova la sua collocazione ideale in locali commerciali o residenziali, integrandosi perfettamente al contesto architettonico. Disponibile in versione quadra e tonda con doppia tipologia di fascio, diffuso o asimmetrico, garantisce il comfort visivo grazie al posizionamento arretrato dell'ottica. Comfort, concepito con l'idea di impreziosire il contesto di installazione, dispone di una versione con e senza cornice, con la possibilità di combinazioni Black-Gold-Red nella versione frame.

Recessed features designed for light commercial and residential spaces. Comfort is studied with the idea of embedding the installation context, has a version with or without frame, with the possibility of Black-Gold-Red combinations in the frame version.





ACCESSORI ACCESSORIES

662
Alimentatore 250 mA SELV
1 per 1 Comfort 10 W
LED driver 250 mA SELV
1 for 1-1 Comfort 10 W

Colore standard 1 settimana
Standard color 1 week

-  **.01** Bianco
White (matt)
-  **.22** Nero
Black (matt)

Colore su richiesta 4/6 settimane
Upon request color 4/6 weeks

-  **.56** Oro spazzolato
Brushed gold
-  **.69** Rosso
Red

A richiesta è disponibile la versione IP65
Upon request is available IP65 version

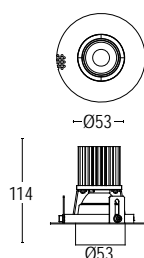

25002.--.31 10W LED 3000K 1250lm
36° ^
max 250mA DC
alimentatore remoto SELV non incluso
remote SELV LED driver not included

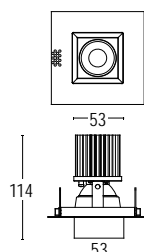





25006.--.31 10W LED 3000K 1250lm
36° ^
max 250mA DC
alimentatore remoto SELV non incluso
remote SELV LED driver not included

Colore standard 1 settimana
Standard color 1 week

-  **.01** Bianco
White (matt)
-  **.22** Nero
Black (matt)

Colore su richiesta 4/6 settimane
Upon request color 4/6 weeks

-  **.27** Nero - oro
Black - gold
-  **.25** Bianco - oro
White - gold
-  **.72** Nero - rosso
Black - red
-  **.71** Bianco - rosso
White - red

A richiesta è disponibile la versione IP65
Upon request is available IP65 version

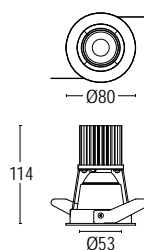

25001.--.31 10W LED 3000K 1250lm
36° ^
max 250mA DC
alimentatore remoto SELV non incluso
remote SELV LED driver not included

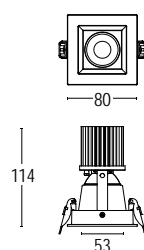

25005.--.31 10W LED 3000K 1250lm
36° ^
max 250mA DC
alimentatore remoto SELV non incluso
remote SELV LED driver not included

BELL



Lampada a sospensione dal design semplice e sinuoso, è sospesa tramite micro-cavo di acciaio inossidabile, che garantisce il perfetto bilanciamento del corpo lampada. Bell è disponibile in due versioni Bell 1 con diametro da \varnothing 31 cm; Bell 2 con diametro da \varnothing 46 cm, diverse dimensioni che rendono l'apparecchio versatile sia in contesti residenziali che in contesti contract.

Design suspension lamp ideal for lighting all types of spaces. Body is in spun aluminum, Micro support cables in stainless steel give an airy quality to the suspension. A wide range of available finishes make it suitable for use in many different interiors.



Colore standard 1 settimana
Standard color 1 week

 **.01** Bianco
White (matt)

Colore su richiesta 2 settimane
Upon request color 2 weeks

 **.19** Grigio argento
Silver grey (matt)

 **.22** Nero
Black (matt)

 **.45** Ruggine
Rust

Colore su richiesta 4/6 settimane
Upon request color 4/6 weeks

 **.27** Nero - oro
Black - gold

 **.25** Bianco - oro
White - gold

 **.72** Nero - rosso
Black - red

 **.71** Bianco - rosso
White - red

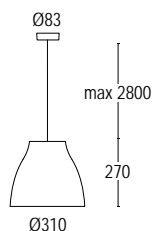

27001.--.31
115° 
220-240V 50/60hz

E27 max 105W

CAVI COLORATI
COLORED CABLES



Da ordinare contestualmente al prodotto
Cable must be ordered with the product

red
orange
yellow
blue
white
black

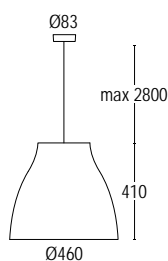

27101.--.31
115° 
220-240V 50/60hz

E27 max 105W

DRUM S

Lampada a sospensione con emissione di luce diretta. La perfezione geometrica conferita dalla circolarità di questo apparecchio, unita alla semplicità del corpo illuminante consentono varie possibilità di installazione: singola in contesti residenziali, modulare in luoghi di accoglienza quali hall di alberghi o ampi spazi commerciali. Il comfort visivo generato da questo apparecchio è garantito dalla presenza del diffusore opalino che chiude il corpo della lampada, emettendo una luce morbida ma dalle elevate prestazioni. Le molteplici finiture materiche disponibili lo rendono versatile in diversi contesti.

Suspension luminaire with direct light emission. The geometric perfection of the design along with its simple lines allow for various installations including residential spaces, contract environments and executive headquarters. Opal diffuser delivers high quality diffused light.

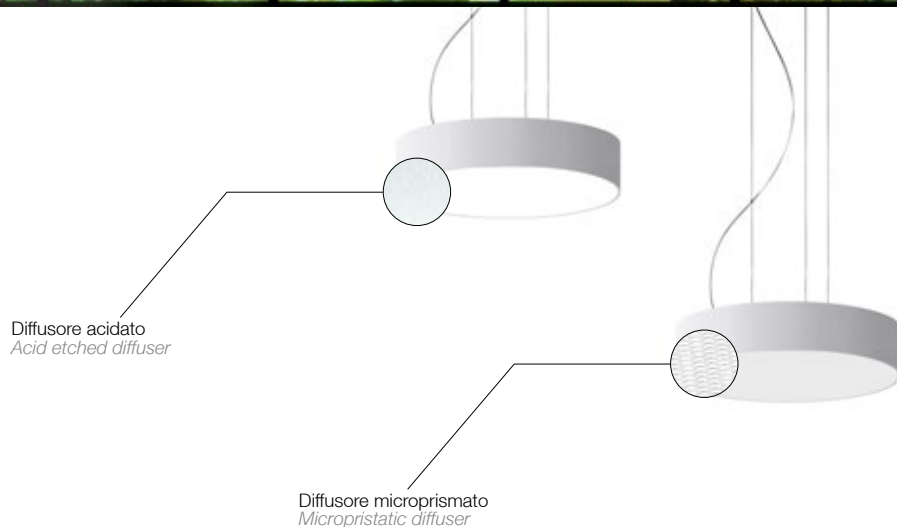

DRUM S

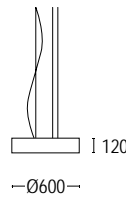

26715.--.31 30W LED 3000K 4800lm
 110° ^
 220-240V 50/60hz
 alimentatore incluso *LED driver integral*
 diffusore acidato *acid etched diffuser*

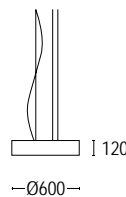

26716.--.31 30W LED 3000K 4800lm
 90° ^
 220-240V 50/60hz
 alimentatore incluso *LED driver integral*
 diffusore microprismato *microprismatic diffuser*

Colore standard 1 settimana

Standard color 1 week

○ **.01** Bianco
White (matt)

Colore su richiesta 2 settimane

Upon request color 2 weeks

● **.19** Grigio argento
Silver grey (matt)

● **.22** Nero
Black (matt)

● **.45** Ruggine
Rust

Colore su richiesta 4/6 settimane

Upon request color 4/6 weeks

● **.51** Effetto fibra di carbonio
Carbon fiber effect

● **.30** Effetto rovere sbiancato
Whitened oak effect

● **.32** Effetto noce
Walnut effect

● **.33** Effetto wengè
Wengè effect

● **.43** Effetto cemento
Concrete effect

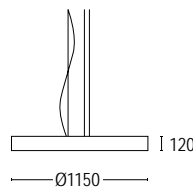

26725.--.31 108W LED 3000K 18000lm
 110° ^
 220-240V 50/60hz
 alimentatore incluso *LED driver integral*
 diffusore acidato *acid etched diffuser*

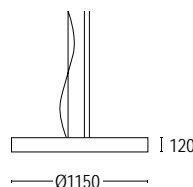

26726.--.31 108W LED 3000K 18000lm
 90° ^
 220-240V 50/60hz
 alimentatore incluso *LED driver integral*
 diffusore microprismato *microprismatic diffuser*

STELO S

Stelo S, lampada a sospensione dal design essenziale a luce diretta. Regolarità e semplicità sono le parole chiave di questo apparecchio. La purezza incontaminata del corpo illuminante si presta perfettamente a creare delle composizioni con questa lampada, grazie alle diverse lunghezze e dimensioni in cui essa è disponibile. Le molteplici finiture materiche disponibili lo rendono inoltre versatile in diversi contesti; Stelo S diventa infatti un elemento dal design raffinato per sale da pranzo, spazi commerciali, o luoghi d'accoglienza. Per una maggiore versatilità l'apparecchio dispone inoltre di due tipologie di ottiche: concentrante o diffusa, garantendo la perfetta illuminazione degli ambienti in cui viene inserito.

Suspension luminaire with essential design and direct light emission. Its simple design allows for various installations including residential spaces, contract environments and executive headquarters. The uncontaminated purity of the design lends perfectly to creating compositions with multiple lamps, thanks to the various lengths and sizes it is available in. Concentrated or diffused optics available, furthering its versatility.



photo by: Germano Borrelli



Finiture speciali
Special finishes

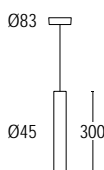

23141.--.31 6W LED 3000K 800lm
 30° ^
 220-240V 50/60hz
 alimentatore incluso *LED driver integral*

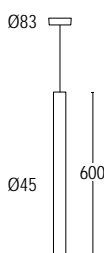

23143.--.31 6W LED 3000K 800lm
 30° ^
 220-240V 50/60hz
 alimentatore incluso *LED driver integral*

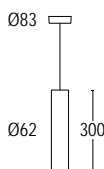

23151.--.31 12W LED 3000K 1800lm
 30° ^
 220-240V 50/60hz
 alimentatore incluso *LED driver integral*

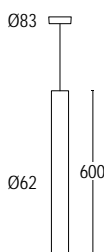

23153.--.31 12W LED 3000K 1800lm
 30° ^
 220-240V 50/60hz
 alimentatore incluso *LED driver integral*

Colore standard 1 settimana
Standard color 1 week

 **.01** Bianco
White (matt)

Colore su richiesta 2 settimane
Upon request color 2 weeks

 **.19** Grigio argento
Silver grey (matt)

 **.22** Nero
Black (matt)

 **.45** Ruggine
Rust

Colore su richiesta 4/6 settimane
Upon request color 4/6 weeks

 **.27** Nero - oro
Black - gold

 **.25** Bianco - oro
White - gold

 **.72** Nero - rosso
Black - red

 **.71** Bianco - rosso
White - red

CAVI COLORATI
COLORED CABLES

 Da ordinare contestualmente al prodotto
Cable must be ordered with the product

- red
- orange
- yellow
- blue
- white
- black

MINIMA



photo by: Germano Borrelli

L'essenzialità coniugata in una sospensione Minima. Il portalamпада cromato conferisce un tocco di eleganza indistinta, e il cavo, disponibile in diverse colorazioni, consente di portare la luce laddove si desidera. Una nuova concezione di illuminazione: il cavo diventa in questa lampada non più un elemento meramente funzionale, ma è una peculiarità della lampada stessa. Correndo lungo i muri, il cavo nero o colorato, consente di generare infinite configurazioni, tutte dal design unico, permettendo quindi di "giocare letteralmente con la luce", collocandone una o molteplici a diverse altezze, in ambienti informali o residenziali.

Essentiality is conjugated to form a suspension called Minima. The chrome lamp holder gives a distinct touch of elegance, and the cable (available in different colours) allows you to bring the light wherever you want. A new concept of illumination: the cable becomes no longer merely a functional element, but is a defining feature of the lamp itself. The coloured cable, allows you to design unique and infinite configurations, allowing you to "play with light", placing one or multiple at different heights, in informal or residential environments.



Colore standard 1 settimana

Standard color 1 week

 **.50** Cromo lucido
Polished chrome

ACCESSORI
ACCESSORIES

 **277**
Gancio di sospensione
Suspension hook

CAVI COLORATI
COLORED CABLES



Da ordinare contestualmente al prodotto
Cable must be ordered with the product

red
orange
yellow
blue
white
black

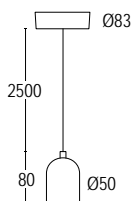

26901.--
340° 
220-240V 50/60hz

E27 max 105W

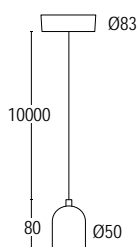

26902.--
340° 
220-240V 50/60hz

E27 max 105W

PRAGMA S

design Francesco Brivio



Elegante lampada a sospensione dalla luce diffusa. Il paralume in policarbonato opalino o cotone plissettato, impreziosito dalla struttura in alluminio, rende la luce emessa da questo apparecchio morbida ma al contempo netta, delicata ma decisa. Pragma è disponibile sia nella versione a sospensione, da terra e tavolo, divenendo in ogni sua conformazione un elemento di design per l'ambiente circostante.

Elegant suspension light providing diffused lighting with an opal diffuser of polycarbonate or pleated cotton. Structure in die-cast aluminium and steel suspension cable. It is possible to mount the lamp off centre by use of a decentralizing support. Available in suspension, floor lamp and table versions.

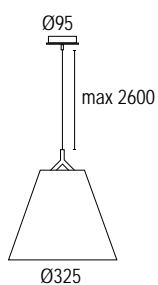



01210.--
340° 
220-240V 50/60hz

E27 max 105W

Colore standard 1 settimana
Standard color 1 week

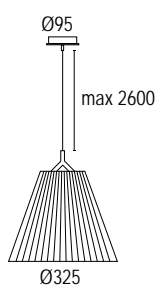
-  **.19** Grigio argento
Silver grey (matt)
-  **.50** Cromo lucido
Polished chrome



01211.--
340° 
220-240V 50/60hz

E27 max 105W

POINT EVO



Point EVO è un proiettore dalla facilissima installazione grazie al sistema magnetico di cui è dotato. La sua forma elegante ed accattivante lo rende particolarmente indicato per l'illuminazione professionale di spazi commerciali, residenziali, uffici e musei. Completamente orientabile sugli assi verticale ed orizzontale garantisce la massima flessibilità di puntamento. Per una maggiore versatilità l'apparecchio dispone inoltre di due tipologie di ottiche: concentrante o diffusa, ed è disponibile in due diverse dimensioni, generando la perfetta illuminazione degli ambienti in cui viene inserito.

Point Evo projector features a magnetic system making it easy to install. It's elegant design makes it ideal for lighting commercial and residential spaces, offices and museums. Complete adjustability on both the horizontal and vertical axes provides maximum flexibility in aiming. Optics available in diffused or concentrated options. Two sizes available.



POINT EVO 0

POINT EVO 1



Colore standard 1 settimana
Standard color 1 week

 **.01** Bianco
White (matt)

Colore su richiesta 2 settimane
Upon request color 2 weeks

 **.19** Grigio argento
Silver grey (matt)

 **.22** Nero
Black (matt)

 **.45** Ruggine
Rust

Colore su richiesta 4/6 settimane
Upon request color 4/6 weeks

 **.27** Nero - oro
Black - gold

 **.25** Bianco - oro
White - gold

 **.72** Nero - rosso
Black - red

 **.71** Bianco - rosso
White - red

ACCESSORI

ACCESSORIES

Solo per Point EVO 1 / only for Point EVO 1



21681.00 Ø 62
Schermo antiabbagliamento
Anti glare screen



26885.79 Ø 62
Diffusore acidato
Acid diffuser



26883.00 Ø 62
Diffusore ellissoidale
Elliptical diffuser



249
Alimentatore 48V
1 per 1-7 Point EVO 0 8W
1 per 1-4 Point EVO 1 14W
LED driver 48V
1 for 1-7 Point EVO 0 8W
1 for 1-4 Point EVO 1 14W

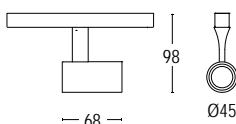

↻ 359°
90°

26801.--.31 8W LED 3000K 800lm
16° ^
max 48V DC
alimentatore remoto SELV non incluso
remote SELV LED driver not included

26802.--.31 8W LED 3000K 800lm
30° ^
max 48V DC
alimentatore remoto SELV non incluso
remote SELV LED driver not included

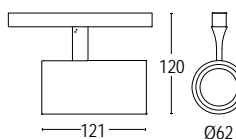

↻ 359°
90°

26815.--.31 14W LED 3000K 2000lm
16° ^
max 48V DC
alimentatore remoto SELV non incluso
remote SELV LED driver not included

26816.--.31 14W LED 3000K 2000lm
30° ^
max 48V DC
alimentatore remoto SELV non incluso
remote SELV LED driver not included

BINARIO MAGNETICO 48V

48V MAGNETIC RAIL TRACK

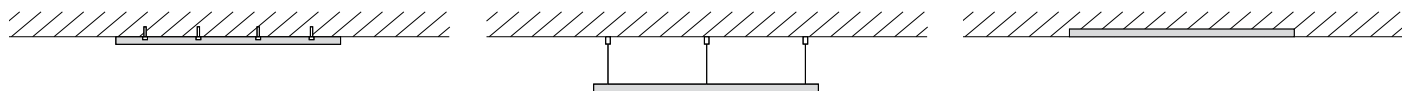

ACCESSORI ACCESSORIES



23695
Alimentazione
Feed



23696
Congiunzione lineare
Linear connector



23689
Testata di chiusura
End cap



23690
Testata di chiusura
per versione incassata
End cup for recessed version



23693
Staffa rinforzo per giunto diretto
solo per versione incassata
*Bracket for direct binary junction
only for recessed version*



23694
Staffa per applicazione incassata
Bracket for trimless



23691
Kit di sospensione
Suspension Kit



249
Alimentatore 48V SELV
1 per 1-7 Point EVO 0 8W
1 per 1-4 Point EVO 1 14W
*LED driver 48V SELV
1 for 1-7 Point EVO 0 8W
1 for 1-4 Point EVO 1 14W*

BINARIO MAGNETICO 48V

48V MAGNETIC RAIL TRACK

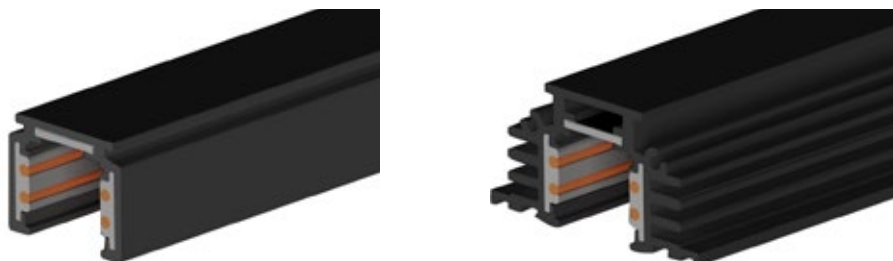

Colore standard 1 settimana
Standard color 1 week

- .01 Bianco
White (matt)
- .22 Nero
Black (matt)

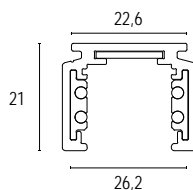

Colore standard 1 settimana
Standard color 1 week

- .22 Nero
Black (matt)

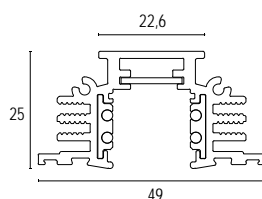

23680.--

Barra elettrificata 4 conduttori 48V 1000 mm
48V 1000 mm 4 conductors rail track

23681.--

Barra elettrificata 4 conduttori 48V 2000 mm
48V 2000 mm 4 conductors rail track

23682.--

Barra elettrificata 4 conduttori 48V 3000 mm
48V 3000 mm 4 conductors rail track

23684.--

Barra elettrificata 4 conduttori 48V 1000 mm
48V 1000 mm 4 conductors rail track

23685.--

Barra elettrificata 4 conduttori 48V 2000 mm
48V 2000 mm 4 conductors rail track

23686.--

Barra elettrificata 4 conduttori 48V 3000 mm
48V 3000 mm 4 conductors rail track

PRAGMA F

design Francesco Brivio



Elegante lampada dalla luce diffusa. Il paralume in policarbonato opalino o cotone plissettato, impreziosito dalla struttura in alluminio, rende la luce emessa da questo apparecchio morbida ma al contempo netta, delicata ma decisa. Pragma è disponibile sia nella versione a sospensione, da terra e tavolo. divenendo in ogni sua conformazione un elemento di design per l'ambiente circostante.

Elegant light providing diffused lighting with an opal diffuser of polycarbonate or pleated cotton. Structure in die-cast aluminium and steel suspension cable. It is possible to mount the lamp off centre by use of a decentralizing support. Available in suspension, floor lamp and table versions.



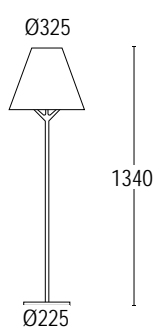

03630.--
340° 
220-240V 50/60hz

E27 max 105W

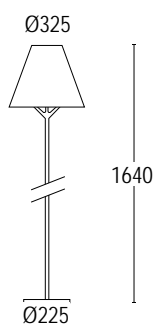

03600.--
340° 
220-240V 50/60hz

E27 max 105W

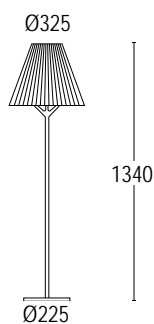

01213.--
340° 
220-240V 50/60hz

E27 max 105W

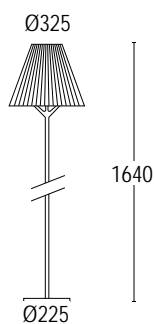

01214.--
340° 
220-240V 50/60hz

E27 max 105W

Colore standard 1 settimana
Standard color 1 week

-  **.19** Grigio argento
Silver grey (matt)
-  **.50** Cromo lucido
Polished chrome

TAXI F

Lampada dal design minimale ed elegante, disponibile in versione a mono e bi emissione. Il corpo costituito da un'estrusione di alluminio e resina polimerica genera altissime prestazioni termomeccaniche, e il riflettore in alluminio purissimo consente un'emissione simmetrica.

Minimal and elegant floor lamp available in single or double emission. Body made in aluminium and resin which deliver high thermo/mechanical performance. Super pure aluminium reflector with asymmetric light distribution.



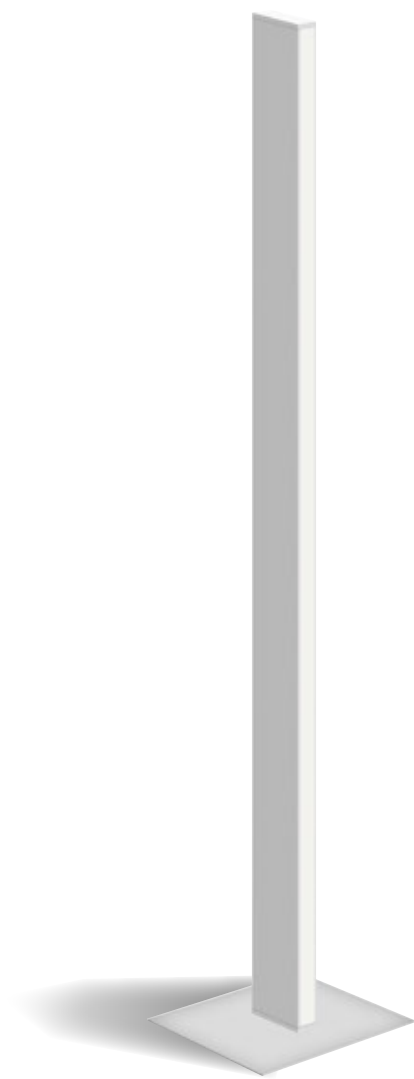

Colore standard 1 settimana
Standard color 1 week

 **.01** Bianco
White (matt)

Colore su richiesta 2 settimane
Upon request color 2 weeks

 **.19** Grigio argento
Silver grey (matt)

 **.22** Nero
Black (matt)

 **.45** Ruggine
Rust

Colore su richiesta 4/6 settimane
Upon request color 4/6 weeks

 **.51** Effetto fibra di carbonio
Carbon fiber effect

 **.30** Effetto rovere sbiancato
Whitened oak effect

 **.32** Effetto noce
Walnut effect

 **.33** Effetto wengé
Wengé effect

 **.43** Effetto cemento
Concrete effect

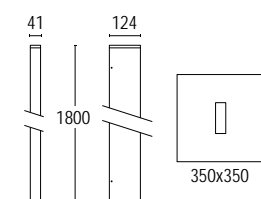

26501.--.31 56W LED 3000K 5600lm
110° ^
220-240V 50/60hz
alimentatore incluso LED driver integral

PRAGMA T

design Francesco Brivio



Elegante lampada dalla luce diffusa. Il paralume in policarbonato opalino o cotone plissettato, impreziosito dalla struttura in alluminio, rende la luce emessa da questo apparecchio morbida ma al contempo netta, delicata ma decisa. Pragma è disponibile sia nella versione a sospensione, da terra e tavolo. divenendo in ogni sua conformazione un elemento di design per l'ambiente circostante.

Elegant light providing diffused lighting with an opal diffuser of polycarbonate or pleated cotton. Structure in die-cast aluminium and steel suspension cable. It is possible to mount the lamp off centre by use of a decentralizing support. Available in suspension, floor lamp and table versions.



PRAGMA T

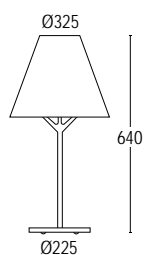

02315.--
340° \wedge
220-240V 50/60hz

E27 max 105W

Colore standard 1 settimana
Standard color 1 week

- **.19** Grigio argento
Silver grey (matt)
- **.50** Cromo lucido
Polished chrome

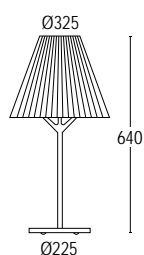

01212.--
340° \wedge
220-240V 50/60hz

E27 max 105W

LINEAR



Lampada dal design essenziale e lineare, la sua installazione può avvenire ad incasso o a muro con emissione di luce diretta. La regolarità e la semplicità del corpo illuminante consentono di inserire questo apparecchio in diverse ambientazioni: singola in contesti residenziali, o modulare in ambienti contract o centri direzionali. Il comfort visivo generato da questo apparecchio è garantito dalla presenza del diffusore opalino che chiude il corpo della lampada, emettendo una luce morbida ma dalle elevate prestazioni.

Recessed or wall mounted fixture with essential linear design covers a wide range of installations. Its simple design allows various installations including residential spaces, contract environments and executive headquarters. Available as single mount or with a modular system. Opal diffuser delivers soft high quality light.



Colore standard 1 settimana
Standard color 1 week

● .48 Alluminio naturale
Smatt white aluminium

LINEAR

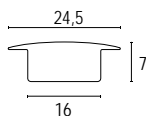

20832.--.31 7W LED 3000K 600lm
110° ^
500 mm
24V 50/60hz
alimentatore remoto SELV non incluso
remote SELV LED driver not included

20833.--.31 14W LED 3000K 1200lm
110° ^
1000 mm
24V 50/60hz
alimentatore remoto SELV non incluso
remote SELV LED driver not included

20834.--.31 28W LED 3000K 2400lm
110° ^
2000 mm
24V 50/60hz
alimentatore remoto SELV non incluso
remote SELV LED driver not included

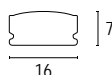

20820.--.31 7W LED 3000K 600lm
110° ^
500 mm
24V 50/60hz
alimentatore remoto SELV non incluso
remote SELV LED driver not included

20821.--.31 14W LED 3000K 1200lm
110° ^
1000 mm
24V 50/60hz
alimentatore remoto SELV non incluso
remote SELV LED driver not included

20822.--.31 28W LED 3000K 2400lm
110° ^
2000 mm
24V 50/60hz
alimentatore remoto SELV non incluso
remote SELV LED driver not included

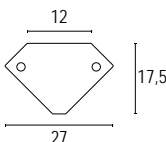

20829.--.31 7W LED 3000K 600lm
110° ^
500 mm
24V 50/60hz
alimentatore remoto SELV non incluso
remote SELV LED driver not included

20830.--.31 14W LED 3000K 1200lm
110° ^
1000 mm
24V 50/60hz
alimentatore remoto SELV non incluso
remote SELV LED driver not included

20831.--.31 28W LED 3000K 2400lm
110° ^
2000 mm
24V 50/60hz
alimentatore remoto SELV non incluso
remote SELV LED driver not included

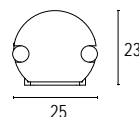

20801.--.31 7W LED 3000K 600lm
110° ^
500 mm
24V 50/60hz
alimentatore remoto SELV non incluso
remote SELV LED driver not included

20802.--.31 14W LED 3000K 1200lm
110° ^
1000 mm
24V 50/60hz
alimentatore remoto SELV non incluso
remote SELV LED driver not included

20803.--.31 28W LED 3000K 2400lm
110° ^
2000 mm
24V 50/60hz
alimentatore remoto SELV non incluso
remote SELV LED driver not included

ACCESSORI ACCESSORIES



20885
Clip fissaggio acciaio
Steel fixing clip



20886
Clip fissaggio plastica
Plastic fixing clip



22028
Alimentatore SELV IP40 50W 24V DC 0-3 metri
LED driver SELV IP40 32W 24V DC 0-3 meters

22029
Alimentatore SELV IP40 100W 24V DC 0-6 metri
LED driver SELV IP40 100W 24V DC 0-6 meters

progetto grafico

graphic layout

studio Ghidini

impaginazione

graphic designer

studio Ghidini

Coordinamento e supervisione

supervising

studio Ghidini

stampato nel mese di Agosto 2018

printed in August 2018

I dati presenti in questo catalogo sono forniti a titolo indicativo. Ghidini Lighting srl si riserva il diritto di variarli in qualsiasi momento e senza preavviso. Consultare il sito web per i dati aggiornati.

The data presented in this catalogue are purely indicative. Ghidini Lighting reserves the right, at its sole discretion, to change, modify, add or remove portions of these data, at any time. Refer to the website for updated information.

I dati fotometrici presenti nel catalogo si riferiscono al flusso della sorgente; consultate i file tecnici fotometrici del sito web per il flusso nominale degli apparecchi.

The photometric data provided on this catalogue are referred to the light source; the photometric data of the luminaire it can be checked on the technical photometric file on the website.

Ghidini Lighting s.r.l.
Via Monsuello, 211 25065
Lumezzane (Brescia) Italy
www.ghidini.it
www.lucitalia.it

OUTDOOR & INDOOR HOME LIGHTING

 GHIDINI LUCITALIA